

木结构钉枪

МОДОН КАРАКАСНЫ ХАДААС БОЛОН БУУ

21 degree plastic strip nails, hot dipped galvanized nails, smooth shank					
Size (mm)	quantity (pieces)	net weight	热镀锌	电镀锌	qty/plt
2.87x50	5000	13.14			60
2.87x60	5000	15.77			60
3.05x83	4000	19.7			48
3.05x90	4000	21.37			48

包装：中性纸箱（牛皮纸箱或白纸箱）



34 degree paper strip nails, hot dipped galvanized nails, smooth shank					
Size (mm)	quantity (pieces)	net weight	热镀锌	电镀锌	qty/plt
2.87x50	5000	13.14			60
2.87x60	5000	15.77			60
3.05x83	4000	19.7			40
3.05x90	4000	21.37			40







包装：中性纸箱（牛皮纸箱或白纸箱）



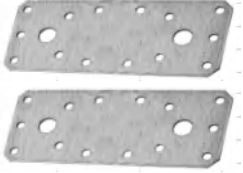







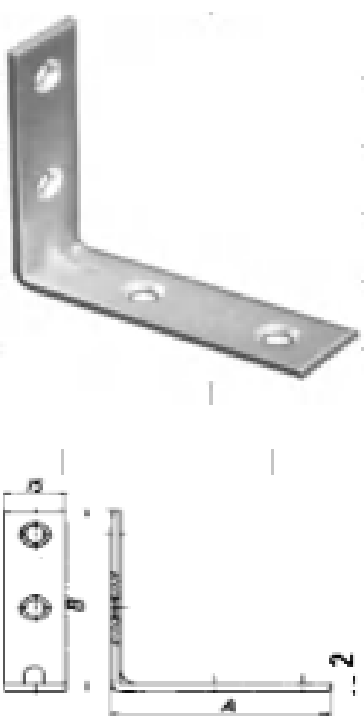
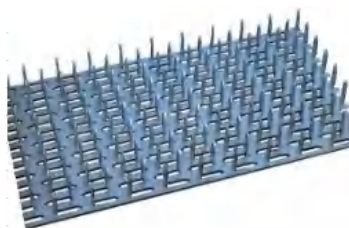

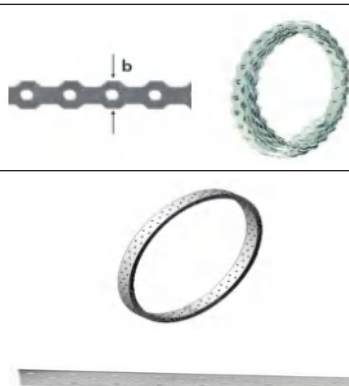
КАНАД БАНЗ ХОЛБОХ ХЭРЭГСЭЛ







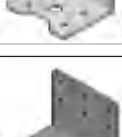
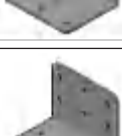























КАНАД БАНЗ ХОЛБОХ ХЭРЭГСЭЛ















No	Код	Хэмжээ	Зураг	Нэгж	Үнэ ₮
1	6107-060	45*120*2		Ш	
2	6107-070	55*140*2		Ш	
3	6107-090	65*180*2.5		Ш	
4	6107-100	90*200*3		Ш	
5	6207-120	45*120*2		Ш	
6	6207-140	55*140*2		Ш	
7	6207-180	65*180*2.5		Ш	
8	6207-200	90*200*3		Ш	
9	6109-044	40*40*40*2		Ш	
10	6109-064	60*60*40*2		Ш	
11	6109-066	60*60*60*2		Ш	
12	6109-068	60*60*80*2		Ш	
13	6109-084	80*80*40*2		Ш	
14	6109-086	80*80*60*2		Ш	
15	6109-088	80*80*80*2		Ш	
16	6108-070	70*70*40*3		Ш	
17	6108-110	110*110*40*3		Ш	
18	6115-080	80*60*40*3		Ш	
19	6115-120	120*60*40*3		Ш	
20	6115-160	160*60*40*3		Ш	
21	6115-200	200*60*40*3		Ш	
22	6208-140	40*140*3		Ш	
23	6208-180	40*180*3		Ш	
24	6208-220	40*220*3		Ш	
25	6208-260	40*260*3		Ш	













Но	Код	Хэмжээ	Зураг	Нэгж	Үнэ ₮
1	6114-135	135*90*65*4		Ш	
2	6114-285	285*90*65*4		Ш	
3	6110-065	90*90*65*1.5		Ш	
4	6110-100	100*100*90*2.5		Ш	
5	6101-020	20*20*15*2		Ш	
6	6101-025	25*25*15*2		Ш	
7	6101-030	30*30*15*2		Ш	
8	6101-040	40*40*15*2		Ш	
9	6101-050	50*50*15*2		Ш	
10	6101-060	60*60*15*2		Ш	
11	6101-070	70*70*15*2		Ш	
12	6101-080	80*80*15*2		Ш	
13	6101-100	100*100*15*2		Ш	
14	6002-056	56*105*15*1.5			Ш
15	6002-084	84*147*15*1.5	Ш		
16	6002-105	105*210*15*1.5	Ш		
17	6013-050	50*17*1		Ш	
18	6013-075	75*23*1.3		Ш	
19	6010-12	5*12*1		M	
20	6010-13	10*12*1		M	
21	6011-28	10*40*2		M	

Зураг	Код	Нэр	Хэмжээ	Нэгж	Үнэ ¥
	HC-1238	H型夹	1*12.7*38	Ш	
	HC-1638	H型夹	1*15.8*38	Ш	
	TP-1	T型连接件	3*100*300*250	Ш	
	TP-1B	T型连接件	3*100*300*250	Ш	
	UC-23840	U型连接件	2*38*40*42	Ш	
	UC-341210	U型连接件	3*46*120*100	Ш	
	TR-1	齿板	50,75,100,125,150	Ш	
	AC-A	水平连接件	2*115*40*40	Ш	
	B25	角铁	3*100*60*100	Ш	
	B26	角铁	3*80*50*80	Ш	
	B28	角铁	2*60*50*50	Ш	
	B30	角码	3*100*80*80	Ш	
	B31	角码	3*80*65*65	Ш	

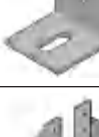
	B3-A	角铁	3*40*50*50	山	
	B4	角铁	2*20*50*50	山	
	B6	角铁	3*40*50*70	山	
	B7	角铁	3*40*60*80	山	
	B8	角铁	3*30*40*40	山	
	BC-2344	角铁	2*35*40*40	山	
	BC-2355	角铁	2*35*50*50	山	
	BC-2455	角铁	2*40*50*50	山	
	BC-310613	角铁	3*100*70*130	山	
	BC-310712	角铁	3*100*70*120	山	
	BC-312612	角铁	3*120*60*120	山	
	BC-312716	角铁	3*120*70*160	山	
	BC-3161016	角铁	3*160*100*160	山	
	BC-3161020	角铁	3*160*100*200	山	

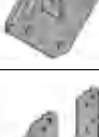













	BC-316612	角铁	3*160*60*120	山	
	BC-316815	角铁	3*160*80*150	山	
	BC-3433	角铁	3*40*35*35	山	
	BC-3445	角铁	3*40*40*55	山	
	BC-3455	角铁	3*40*50*50	山	
	BC-3459	角铁	3*40*50*90	山	
	BC-36517	角铁	3*60*50*170	山	
	BC-3659	角铁	3*60*50*90	山	
	BC-36815	角铁	3*60*80*150	山	
	BC-381016	角铁	3*80*90*170	山	
	BC-381515	角铁	3*80*150*150	山	
	BC-3859	角铁	3*80*50*90	山	
	BC-38612	角铁	3*80*60*125	山	
	BW-2344	角铁	2*35*40*40	山	

	BW-2455	角铁	2*40*50*50	山	
	BW-24551	角铁	2*40*50*50	山	
	BW-2466	角铁	2*40*60*60	山	
	BW-2477	角铁	2*40*70*70	山	
	BW-2633	角铁	2*60*32*32	山	
	BW-31099	角铁	3*100*90*90	山	
	BW-3121111	角铁	3*120*110*110	山	
	BW-31277	角铁	3*120*70*70	山	
	BW-3161111	角铁	3*160*110*110	山	
	BW-341111	角铁	3*40*110*110	山	
	BW-3433	角铁	3*40*35*35	山	
	BW-3455	角铁	3*40*50*50	山	
	BW-3477	角铁	3*40*70*70	山	
	BW-34811	角铁	3*40*80*110	山	

	BW-34815	角铁	3*40*80*150	山	
	BW-361111	角铁	3*60*110*110	山	
	BW-3633	角铁	3*60*35*35	山	
	BW-3677	角铁	3*60*70*70	山	
	BW-3877	角铁	3*80*70*70	山	
	MP34A	小型水平连接件	2*65*35*35	山	
	TJ-11	角铁	2*50*50*50	山	
	TJ-12	角铁	3*50*50*50	山	
	RT15A-38	飓风卡件	2.0*135*135	山	
	RT15A-45	飓风卡件	2.0*142*135	山	
	RT15A-70	飓风卡件	2.0*166*148	山	
	RT7A	抗风拉件	2.0*40*164	山	
	RT7B	抗风拉件	2.0*40*164	山	
	RT8A	飓风卡件	2*40*40*292	山	

	PT7A	栏杆连接件	2.0*38*110	山	
	PT8A	栏杆连接件	1.2*30*144	山	
	JUS-1213	梁托	2*120*130	山	
	JUS-1218	梁托	2*120*180	山	
	JUS-1222	梁托	2*120*220	山	
	JUS-18910	梁托连接件	1*89*100	山	
	JUS-38A	梁托	2*38*135	山	
	JUS-38B	梁托	2*38*194	山	
	JUS-38C	梁托	2*38*151	山	
	JUS-38D	梁托	2*38*89	山	
	JUS-45A	梁托	2*45*94	山	
	JUS-50A	梁托	2*50*137	山	
	JUS-50B	梁托	2*50*92	山	
	JUS-60C	梁托	2*60*141	山	

	JUS-70A	梁托	2*70*94	山	
	JUS-76A	梁托连接件	2*76*175	山	
	JUS-76AI	梁托	2*76*175	山	
	JUS-76B	梁托连接件	2*76*200	山	
	JUS-76C	梁托	2*76*140	山	
	JUS-76F	梁托	2*76*244	山	
	JUS-89A	梁托	2*89*170	山	
	JUS-89AI	梁托	2*89*170	山	
	JUS-89B	梁托连接件	2*89*127	山	
	LD-13C	木屋拉带	1*35*C	山	
	LD-2312	木屋拉带	2*35*1200	山	
	LJ-3830-DX	抗风拉件	1.2*38*300	山	
	PL-1	平板横梁连接件	3*100*300	山	
	PL-2	家具平板连接件	2*20*125	山	

	PL-21020	平板横梁连接件	2*100*200	山	
	PL-2814	平板横梁连接件	2*80*140	山	
	PL-31030	平板横梁连接件	3*100*300	山	
	PL-31031	平板横梁连接件	3*100*300	山	
	PL-5	平板横梁连接件	3.0*100*155	山	
	PL-6	平板横梁连接件	3.0*100*155	山	
	PL-7	平板横梁连接件	3.0*80*124	山	
	PL-8	平板横梁连接件	3.0*80*124	山	
	PL-AC	平面连接件	2*68*114	山	
	B5	平面角铁	2*80*80	山	
	PL-21	平板横梁连接件	3.0*150*150	山	
	JT14A	平板横梁连接件	2.0*77*163	山	
	HD20	隐藏式露台连接件	2.0*20*37.8	山	
	WE-AS	可调型预埋件	3.0*85*200	山	

	AC-CL	抗拔紧固件	2.0*35*114	山	
	AC-CR	抗拔紧固件	2.0*35*114	山	
	JUS-76BF	抗拉拔紧固件	2*82*203	山	
	JUS-76CF	抗拉拔紧固件	2*76*185	山	
	PU-31412	柱脚连接件	3*140*123*120	山	
	PU-38980	柱脚连接件	3*89*89*80	山	