

B BUSINESS SCOPE
经营范围

BUSINESS SCOPE

缜密施工 专业打造行业典范

经营范围

铝塑板、彩钢板、铝单板、铝蜂窝板
金属板、金属管、建筑材料、涂料、
胶水、货物进出口、技术进出口



东元国际
INTDERNATIONAL



DONGYUAN

东元国际
INTDERNATIONAL

PRODUCTS
产品展示

PRODUCTS

我们永不懈怠 追求更大的成功





东元国际
INTDERNATIONAL

PLASTIC COMPOSITE
铝塑板

PLASTIC COMPOSITE

我们永不懈怠 追求更大的成功

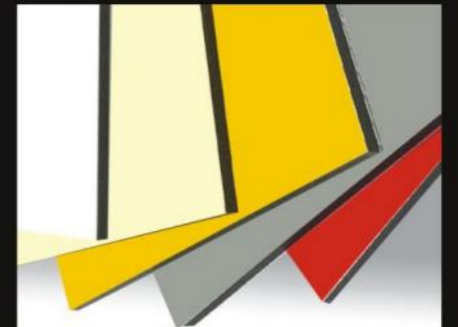
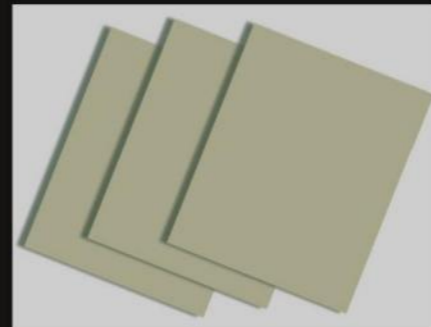
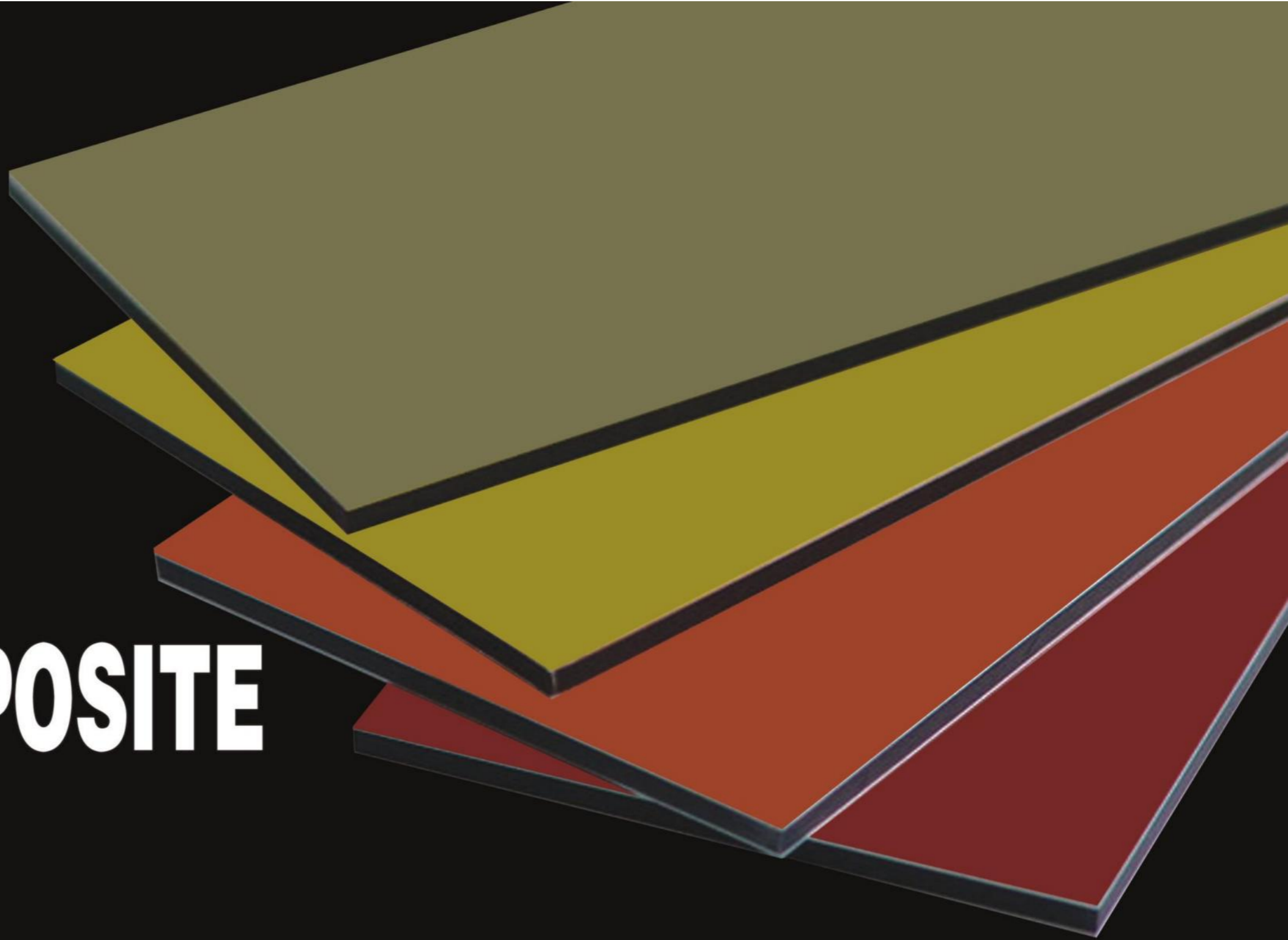

PRODUCTION EQUIPMENT

我们永不懈怠 追求更大的成功

一、化成线

化成线起着清洗铝卷表面附着的一层轧压过程中轧压润滑油，防氧化油脂及各种污垢的作用，并去掉硅、镁、铁、铜等不纯物在铝材表面的沉积。公司选用德国汉高公司的优质化工原料及技术对其表面进行化成处理，在铝卷表面形成结构致密的蜂巢状氧化皮膜，使油漆与铝卷通过这一中介物紧紧地结合在一起，具有良好的附着力。

二、精密涂装线

精密涂装线是将化成后的铝卷按客户所需涂装各种油漆。公司涂装采用国际先进水平的精密三辊逆向滚涂机，在封闭无尘的状态下进行精密涂装，使涂膜厚度和涂层外观质量得到良好控制。烤炉分四区控温烘烤，使涂层的耐溶剂性、硬度、柔韧度均达到最佳状态。具有良好的光泽性、附着力和抗腐蚀性。

一、Chromating line

Chromating line cleans the rolling lubrication that adhered to aluminum coil surface to prevent oxidizing oil and dirt, and gets rid of impurities deposited on coil surface like Si, Mg, Fe, Cu etc. Our company chooses excellent chemical raw materials and technology from Henkel Germany to do chromating treatment to the surface, and form a compact scrobiculate oxide film, which enhances the adhesion, and makes the lacquer and the aluminum surface combined tightly.

二、Precision coating line

Precision coating line paints the chromated aluminum coils with various paints according customer's requirements. Our company applies international advanced leveled precision three-roller converse coating machine, and paints in a close, dust free condition, giving the coating film surface very good gross, adhesion, anticorrosion property.

三、连续热贴复合线

连续热贴复合线是铝塑复合板成型的关键设备，其作用是使铝材、芯材与高分子膜在连续高热高压的作用下牢固地粘合，形成平整板面。公司选用进口高分子膜，依靠先进的设备，完善的工艺，严格的控制，使铝塑复合板具有超强的剥离度，已经超出进口板的指标。

本公司引进德国生产线，一流的产品必须拥有一流的品质保证，我们拥有专业的加工、检测设备和雄厚的技术实力。

引进国外最先进的双涂双烘滚涂自动生产线、铝单板多功能自动生产流水线，采用美国PPG (KYNAR500) 氟碳树脂涂层和德国汉高皮膜化处理技术加上严格、规范的科学管理，保证了产品的高质量和高档次，给我们带来了一个五彩缤纷的梦幻世界。

三、Continuous hot laminating line

Continuous hot laminating line is the key equipment or molding an aluminum composite panel.

It makes the aluminum, core material and macromolecule film combined tightly under the continuous high temperature and high pressure, thus forms a flat panel. We choose imported macromolecule film, use advanced equipments, and perfect technology and strict control to give the aluminum composite panel a super peeling strength, which has exceeded standards of imported panels.



CHARACTERISTICS

我们永不懈怠 追求更大的成功

**(一) 经济性
ECONOMY**

铝塑板采用各种优质涂层, 无需长期保养, 免除了现代高层大型化建筑物在保养及维修方面的花费。我国的城市污染较为严重。使用几年后需要保养和清理, 本产品由于自洁性好。只需中性的清洗剂和清水即可。洗涤后使板材永久如新。
The APCP board adopts a variety of high-quality aluminum-plastic coating. Dispenses with long-term maintenance, and avoids the costs on the maintenance and repair of modern high-rise buildings. China's urban pollution is more serious. After a few years, there must come into the needs of maintenance and cleaning. The APCP board shares the advantage of self-cleaning, which make the plate as new only need to clean with neutral detergent and water.

**(二) 耐用性
DURABILITY**

氟碳涂层铝塑复合板具有持久性、耐候性、耐高温、耐磨性、耐污性等优良性能。
Fluorocarbon coating APCP is of durability. Weather ability, heat-resistance, Abrasion resistance, and excellent tolerance.

**(三) 平整性
LEVELNESS**

铝塑板提供卓越的平整性表面, 满足了现代建筑对高级感的追求。
The APCP board provides excellent-levelness surface, which satisfied the pursuit for fashionable modern architecture.

**(四) 质轻性
LIGHTNESS**

铝塑板采用了铝合金及可塑性塑料复合而成, 重量比其他装饰材料轻, 减少材料本身重量负担, 方便施工, 大大缩短工期。
The APCP board compounded form aluminum alloy and plastic. Which holds less weight than other decorative materials to reduce the weight of its own burden, to facilitate construction. And greatly reduce the project time.

**(五) 易施工性
EASY TO CONSTRUCTION**

铝塑板易切割、裁剪、刨沟、弯曲成圆弧、直角等各种造型, 可充分配合装修业设计各种的造型变化。
The APCP board is easy for incision, cutting, planning ditch, bending into a circular, rectangular and various forms, it can fully coordinate with various shape changes in decoration and design.

**(五) 防火性
FIREPROOFING**

铝塑板不可燃的表层铝片, 可保护聚乙烯芯材料, 并形成燃烧初期阻隔传导, 防火性达到国际标准。
The non-combustible aluminum-plate surface of APCP board can protect polyethylene core materials, and form the early formation of combustion blocking conduction; its function of fireproofing meets the international standards.

**(七) 设计发挥性
DISPLAY OF THE DESIGN**

铝塑板能根据客户要求制造出特定的色泽与形态, 能满足建筑师独具匠心的设计, 实现完美的装饰效果。
The APCP board based on the customer requirement to create a specific color and shape. Which can meet the discerning design of the architects to achieve perfect decorative effect.

**(八) 环保性
ENVIRONMENTAL PROTECTION**

表层不发生变化, 对环境无污染。
No curved surface and of no pollution to the environment.

铝塑板产品的实用范围

机场、码头、地铁、宾馆、酒店、娱乐场所、高档住宅、别墅、办公楼的幕墙装饰及室内装饰
大型广告招牌、展示橱窗、路边报亭、书摊、电话亭、交通岗亭、路边加油站
室内墙壁、天花板、隔间、厨房、卫生间、墙脚护壁
店面装修铺内货架、内柜、家俱
列车、汽车、轮船、客车车厢装饰
旧楼翻新改造
净化防尘工程
Airport, dock, subway, guesthouse, hotels, entertainment venues, luxury homes, villas, office buildings and interi decoration of the wall.
Large signboards, displaying window, roadside newsstand, bookstand, telephone, booth, traffic booth, roadside, filling stations, indoor walls, ceilings, partitions, kitchens, bathrooms, retaining walls
Store furnishings, shop inner planes, cabinet, poles, furniture
Train, cars, steamboats, carriage, decoration
Renovation of old buildings
Dust purification project

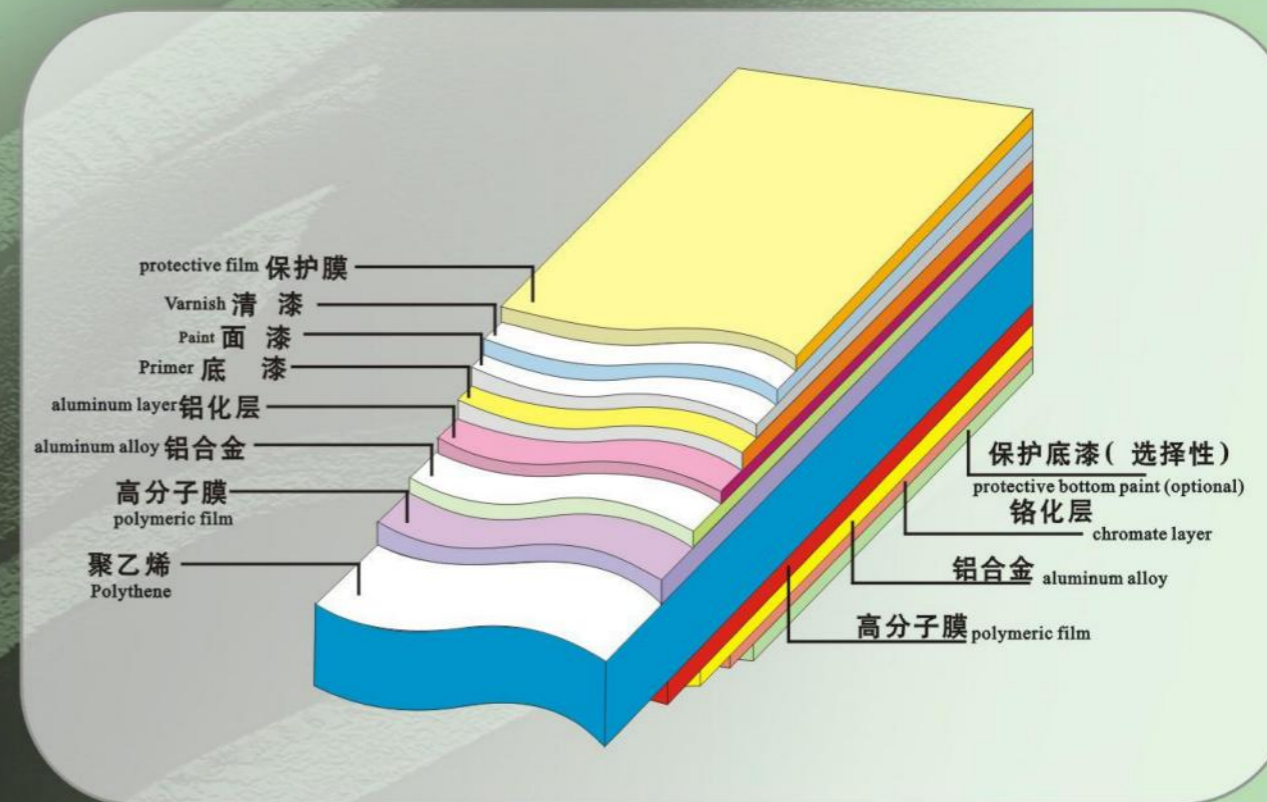

产品规格:

1. 标准尺寸: 厚度(T)1mm 2mm 3mm 4mm
2. 宽度(W): 1220MM 1250MM 1600MM
3. 长度(L): 2440mm~6000mm
4. 特殊尺寸规格可按客户需求定做。
5. 表面涂层: 氟碳树脂(PVDF), 聚酯树脂(PET)以及其他仿大理石、仿木纹表层
6. 芯材: 防火阻燃芯材, 高压低密度聚乙烯(PE)等

Product specifications:

1. standard size: thickness(T)1mm 2mm 3mm 4mm
2. width(W): 1220MM 1250MM 1600MM
3. length(L): 2440mm~6000mm
4. special size specifications can be tailored to customer needs.
5. surface coating: fluorocarbon resin(PVDF), polyester(PET) and other imitation marble, wood-like surface.
6. core material: wood-fire flame-retardant, high-voltage low-density polyethylene(PE).

ALUMINUM VENEER

我们永不懈怠 追求更大的成功

Advanced automatic
production line | ____aluminum
veneer assembly line
先进的自动生产线之一
——铝单板流水线

引进国外先进的全自动高压静电喷涂自动生产线，完善的各型加工生产设备，美国（KYNAR500）氟碳树脂涂层和德国汉高皮膜化成处理技术。精湛的加工工艺和高品质的产品可以完美地展现装饰设计大师富有创意的造型，充分渲染绚丽多姿的建筑美景，给建筑美以新的定义。

Advanced automatic high pressure electrostatic spraying painting production line and complete shaping devices are introduced. Also Fluorine-carbon resin coating and German Henkel surface pretreatment technology are adopted. Exquisite process and high quality products exhibit the original designs of our decorating designers to improve the colorful construction landscape, which give a new definition to construction beauty.



ALUMINUM VENEER

我们永不懈怠 追求更大的成功

铝单板

铝单板可加工成不同规格的平板、双曲面板、异型板等各种复杂形状。钣金成型后，经过表面处理，可进行氟碳喷涂、丙稀酸喷涂及粉末喷涂，色彩可任意选定，广泛应用于室内外装饰。

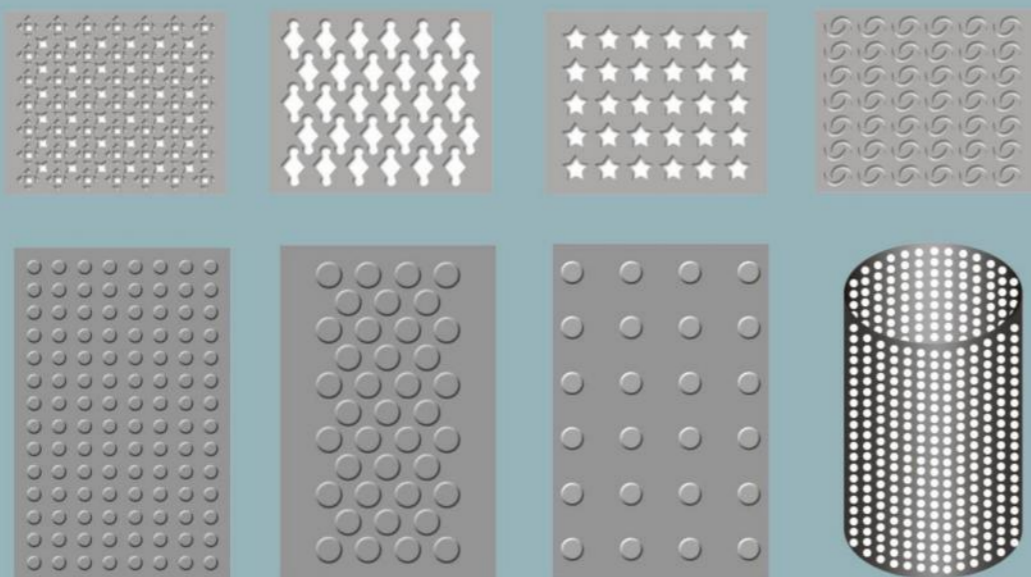

凹凸冲孔数码板

该产品是在不同的板材上进行造型孔或凹凸孔加工，用于满足装饰、展示需要，图形、布孔可根据客户要求多种变化，成型后表面进行色彩处理，为设计师提供了更加时尚的选材空间。

常用铝板有：
1100、3003 (LF21) 等牌号

铝板厚度为：
2mm、2.5mm、3mm

最大尺寸为：根据客户要求

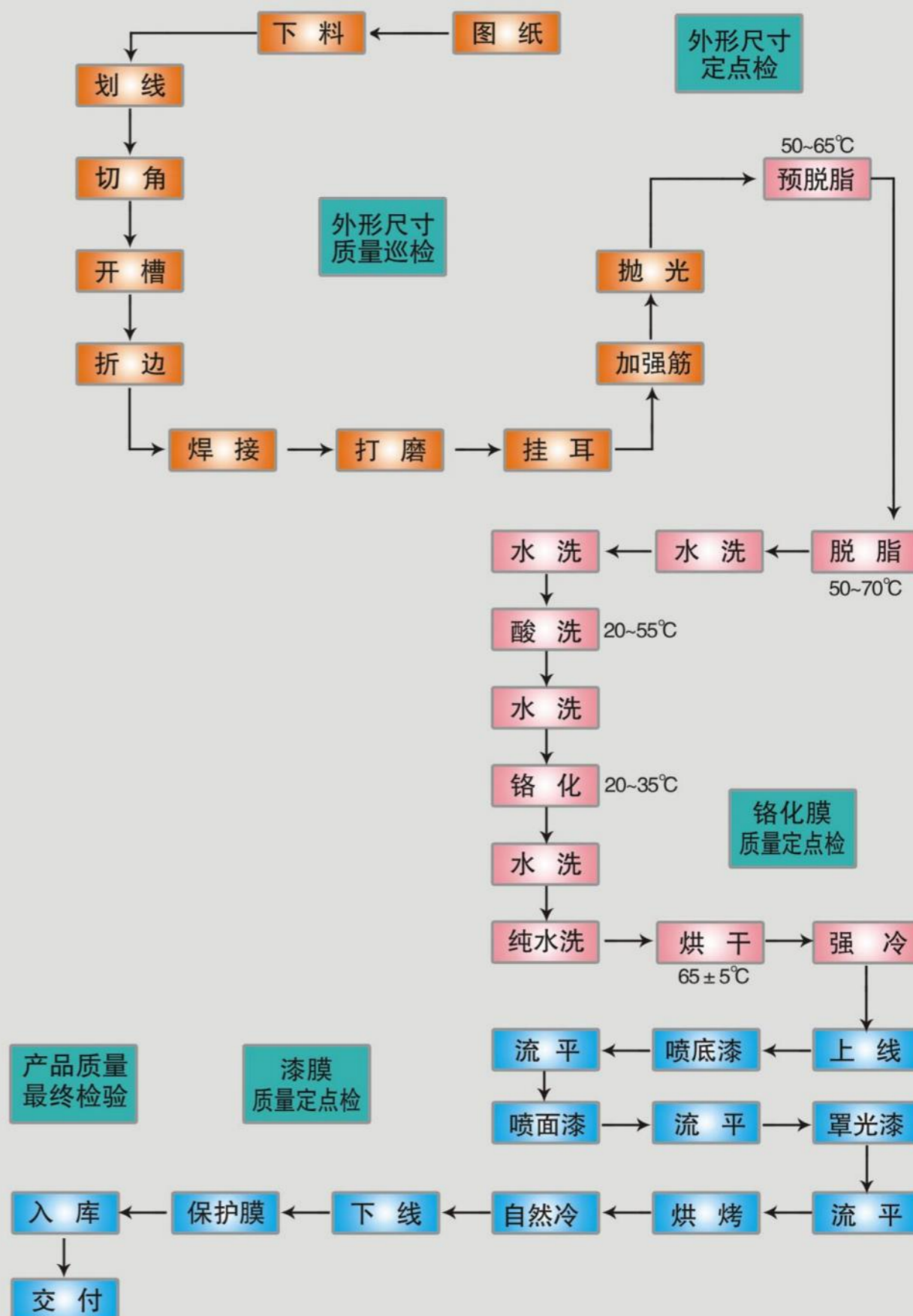

ALUMINUM VENEER

我们永不懈怠 追求更大的成功

广泛用于建筑装饰,如宾馆、酒店、写字楼、商场、机场、体育馆等现代化建筑的幕墙、室内外标志装饰及广告标志牌等。

耐腐蚀性

表面氟碳喷涂KYNAR500树脂含氟量高,能有效抵抗酸雨、空气污染及紫外光的侵蚀。

无光污染

由于氟碳涂层为亚光表面(光泽度为35左右),形成漫反射,不会造成光污染。

自清洁性

氟碳涂层由于氟中KYNAR500特殊分子结构使其表面灰尘根本不能依附,故有极强的自清洁性。

颜色丰富

氟碳涂料颜色丰富,达数百种,还可根据用户要求创作特殊颜色。

高强度

所采用的优质防锈铝强度高,由于开口处采用焊接工艺,大大提高了铝板的刚性,确保了幕墙的抗风、防震、防雨水渗漏、防空气渗透、防雷、抗冲击的效果。

铝单板安装示意图

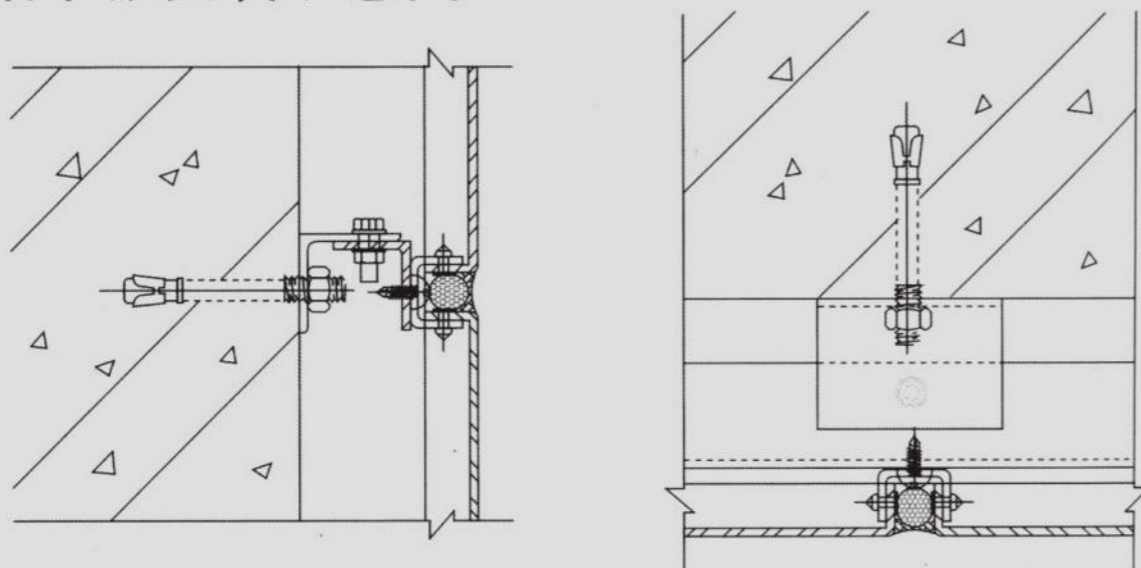

产品特点

A: 本公司生产的金属铝单板是采用1100H24、3003H24、5005H24单层铝合金板做基板。其厚度有0.1mm~5.0mm等各种规格。金属单板的结构主要由面板、加强筋、挂耳等部件组成。有要求时板背面可填隔热矿岩棉。挂耳直接由面板折弯而成,亦可在面板上另外加装。为了确保金属单板在长期使用中的平整度,我们在面板背面装有加强筋,通过螺栓把加强筋和面板相连,使其形成一个牢固的整体,从而增加其强度和刚性。

B: 单层铝幕墙板的优点

- 1、重量轻、刚性好、强度高
- 2、耐候性和耐腐蚀性好
- 3、可加工性强,可加工成平面、弧形面和球面等各种复杂的形状
- 4、色彩可选性丰富、装饰效果好
- 5、不易沾污、便于清洁、保养
- 6、安装施工方便、快捷
- 7、可回收再处理、有利环保

C: 单层铝幕墙板的应用

- 1、幕墙
- 2、柱梁、阳台、隔板包饰
- 3、室内装饰
- 4、广告标志牌
- 5、车厢、家具
- 6、展台
- 7、仪器外壳、仪表板

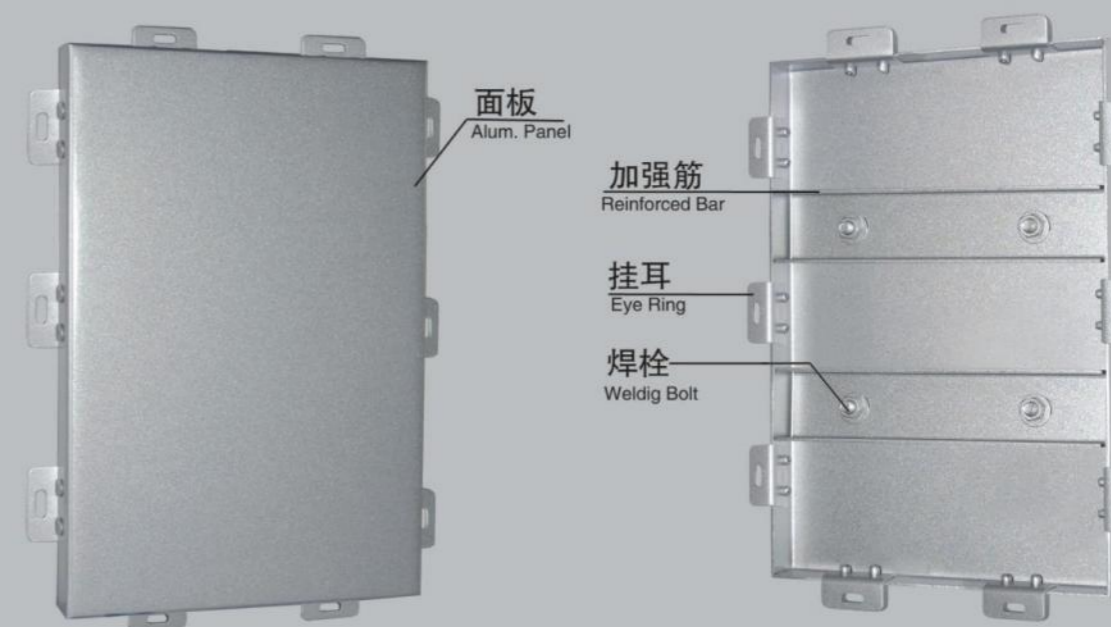

根据要求可加隔热矿岩棉

Heat-insulating mineral wool could be added by request.

SUSPENDED CEILING

条板吊顶天花 Strip & linear ceiling

条板天花系列是众多标准天花系列中一款经典，它是采用滚压成型，具有平坦的表面，流畅的线条，被广泛应用于机场、展览室、会展中心、车站、商场、写字楼、地铁站等等。

C型长条系列天花包括C75, C150, C300, C400等几种，长条天花体现出平整，无缝或间缝的装饰效果，在视觉上给人流线型的舒畅感受；可以从型号，颜色相互搭配，充分发挥设计思维，组合吊装出新视觉的天花板。C300长条天花上还配有防风片，可以防止起风吹掉天花板。

基材主要采用优质3003H24铝合金板，厚度为0.5~1.0mm，表面通过铬化处理再经过喷涂或辊涂而成。

安装方式：采用扣挂式，便于安装拆拆卸。

Lath ceiling ceiling series is one of many criteria in a classic series, it is the use of roll forming, with a flat surface, smooth lines, are widely used in airports, exhibition rooms, convention centers, railway stations, shopping malls, write On House, subway station and so on.

C-long series of smallpox, including C75, C150, C300, C400, such as several, long ceiling reflects the smooth, seamless or seam between the decorative effect, gives a visual feel comfortable streamlined; available from the model, each color with, give full play to design thinking, the combination of a new vision lifting the ceiling. C300 comes with wind on the long piece of smallpox, can prevent the wind blows, blow off the ceiling.

Substrate mainly made of high quality 3003H24 aluminum alloy plate, thickness 0.5 ~ 1.0mm, the surface and then by chromium treatment made by spray or roller.

Installation: hanging with buckle, easy to install demolition demolition.

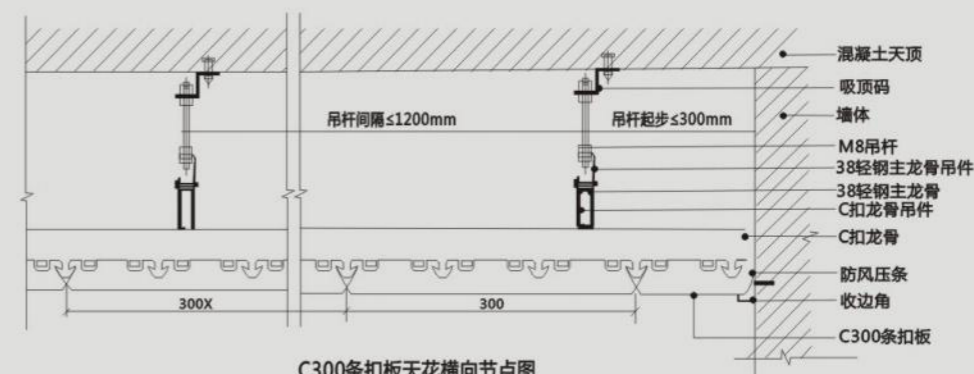
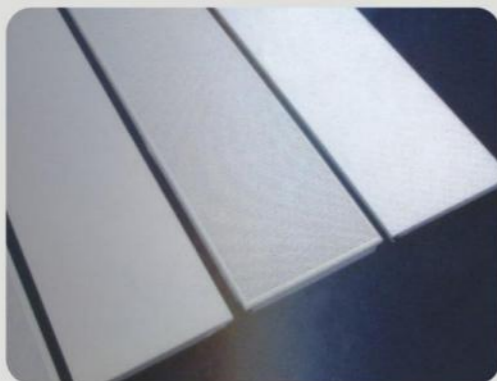

C300条扣板天花横向节点图

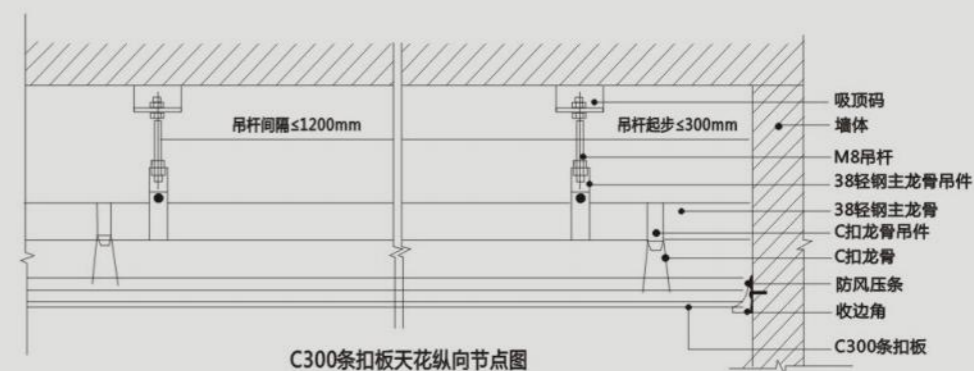

C300条扣板天花纵向节点图

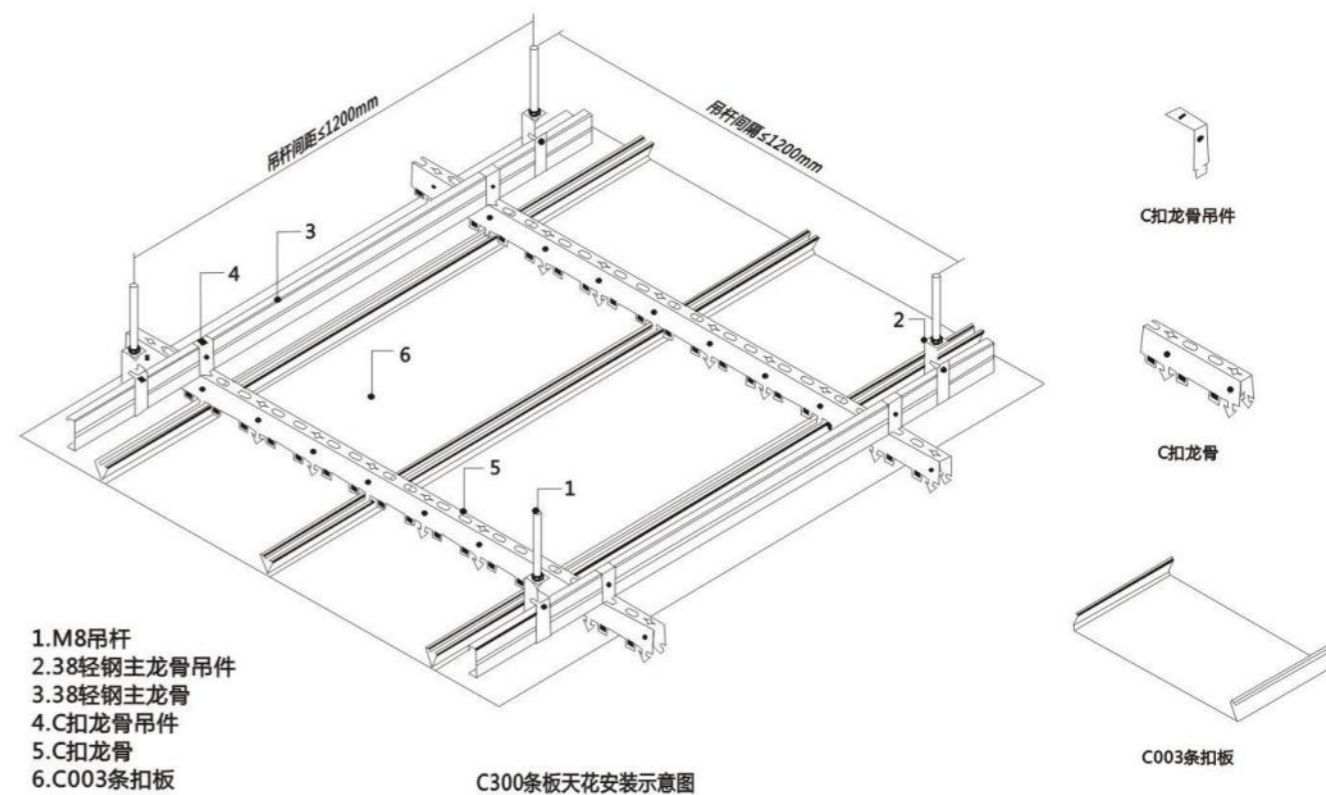

1. M8吊杆
2. 38轻钢主龙骨吊件
3. 38轻钢主龙骨
4. C扣龙骨吊件
5. C扣龙骨
6. C003条扣板

C300条板天花安装示意图

SUSPENDED CEILING

方板吊顶天花 Square ceiling

方板天花具有平坦的表面及方正庄重的外观，所以一直都是办公室装修的首选。方板天花以吊装方式来分，又分为明架方板天花及暗架方板天花两大类。方板天花主要有以下几种规格：600X600mm、500X500mm、300X300mm，600X1200mm、300X1200mm等等。

基材主要采用优质3003H24铝合金板，厚度为0.7~1.2mm，表面通过铬化处理再经过喷涂或辊涂而成。

安装方式：采用扣挂式(暗架)或龙骨直托式(明架)，非常便于安装拆卸。

Square plate with a flat ceiling surface and Founder stately appearance, it has always been the first choice for office decoration. Square plate smallpox way to lifting points and frame is divided into clear and dark square frame square ceiling board ceiling board two categories.

Side board ceiling are mainly the following specifications:

600X600mm, 500X500mm, 300X300mm, 600X1200mm, 300X1200mm and so on.

Substrate mainly made of high quality 3003H24 aluminum alloy plate, thickness 0.7 ~ 1.2mm, the surface treatment by chromium Then made by spraying or roller coating.

Installation: Hanging with buckle (dark frame), or direct care keel type (next frame), very easy installation and removal.

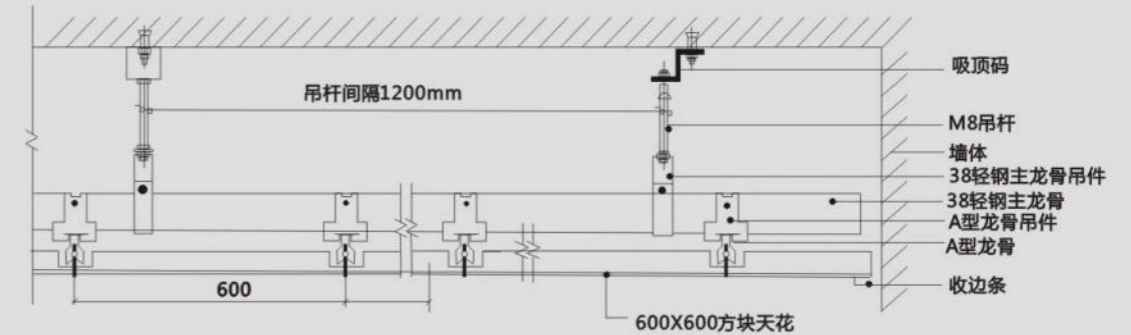

暗架式天花结构横向剖面图

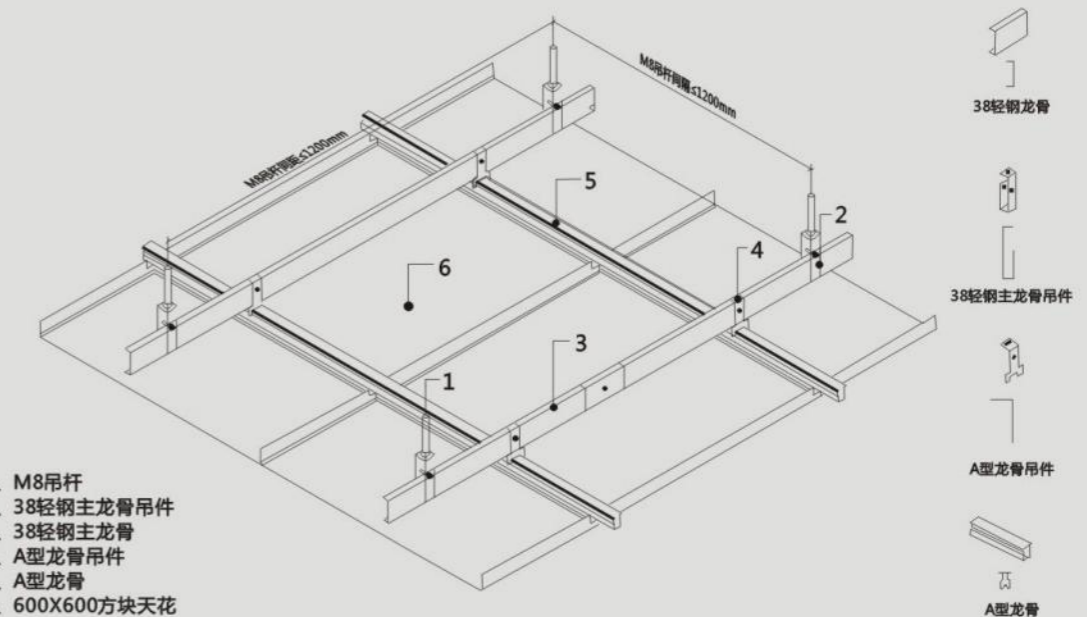

方板暗架式结构安装图

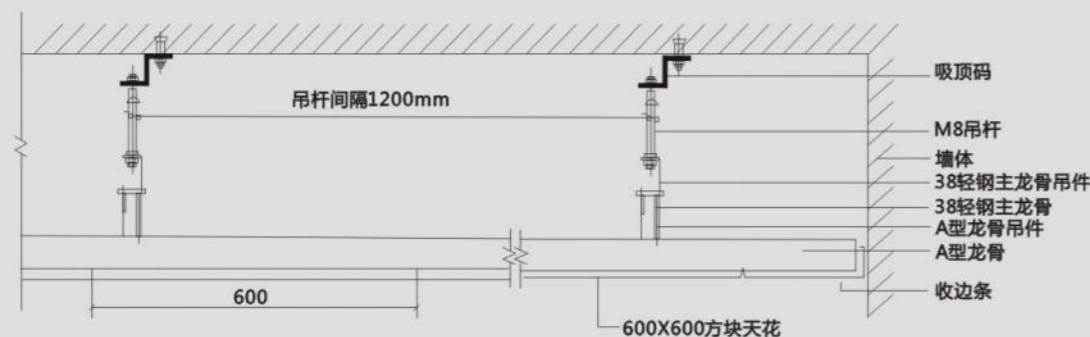

暗架式天花结构纵向剖面图

SUSPENDED CEILING

勾搭吊顶天花 Soliciting ceiling

勾搭天花整体组装更给人一种明快流畅的视觉感观，它更可以根据设计要求定做尺寸。基材主要采用优质3003铝合金板，厚度为1.2~3.0mm，表面通过铬化处理再经过喷涂或辊涂而成。

使用区域：主要应用于大堂、走廊、会议室等不规则或多规格尺寸的天花吊顶。

Soliciting the overall ceiling giving a bright and smooth assembly also an eyesore, it also can design custom size. Mainly high-quality 3003 aluminum alloy substrate plate, thickness 1.2 ~ 3.0mm, surface treatment and then after by chromium coating Or roller made. Use areas: Main workers used the lobby, corridors, meeting rooms and size of irregular size or ceiling.

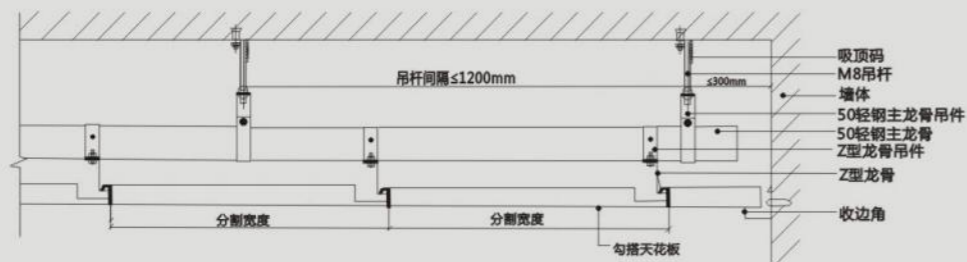

勾搭天花横向剖面



勾搭天花横向剖面

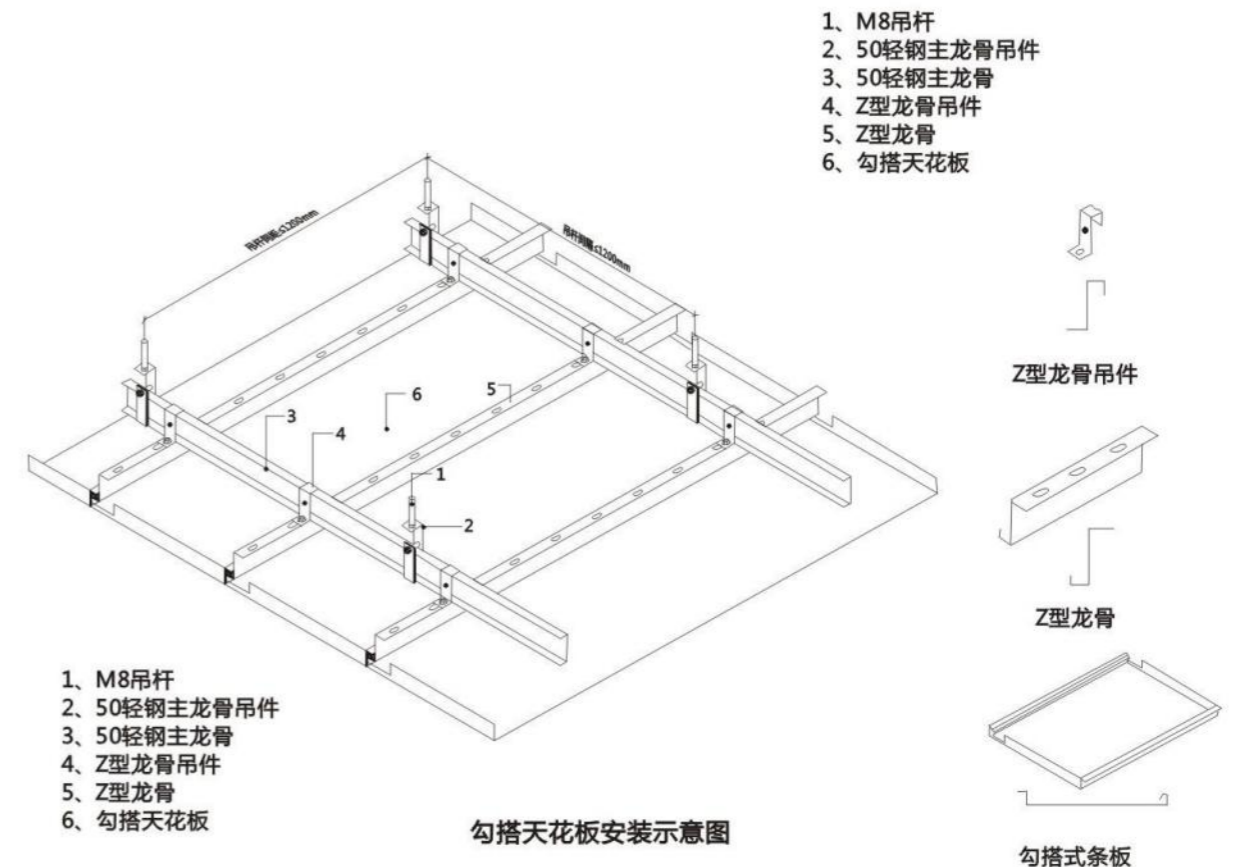
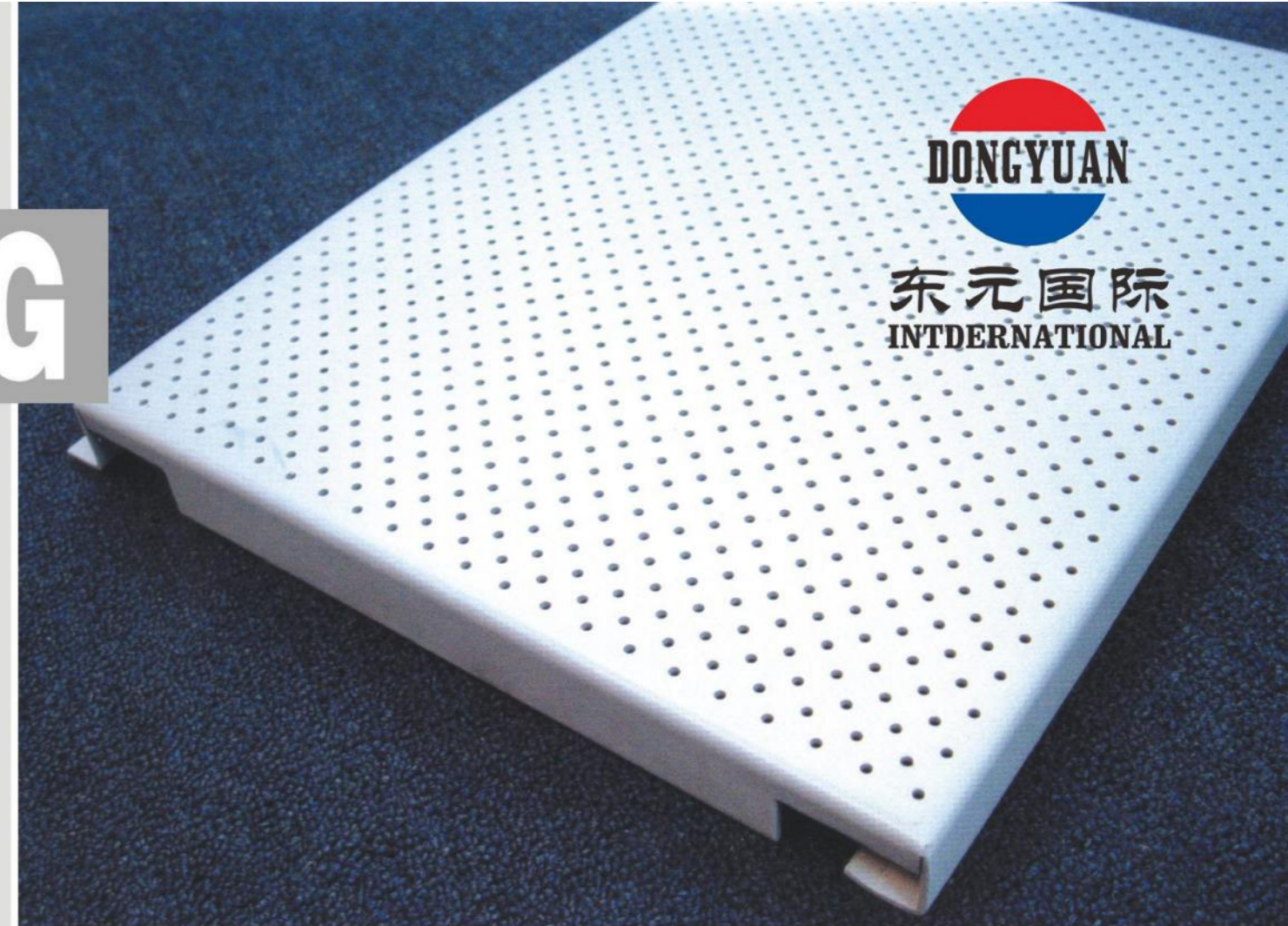

挂片吊顶天花 Blade ceiling

挂片天花板的种类繁多，有U形挂片、水滴形挂片、三角形挂片、圆管形挂片、单片挂片、灯罩形挂片等等；它们都有共同的特点：畅透式设计、立体感强、通风性好。

基材主要采用优质3003铝板或6063型材，厚度为0.7~2.0mm，表面通过铬化处理再经过喷涂或辊涂而成。

使用区域：主要应用于大堂、机场、地铁站等人流量大的公共场所。

Wide variety of ceiling hanging piece has U-shaped hanging piece, drop-shaped hanging pieces, triangles hanging pieces, pipe Coupon-shaped, single hanging piece, lampshade-shaped hanging pieces, etc.; they all have in common: Chang through the design, Stereoscopic, ventilation is good.

Substrate mainly made of high quality 3003 aluminum or 6063 profile, the thickness 0.7 ~ 2.0mm, the surface through After chromium treatment and then spray or roller made.

Use area: mainly used in lobbies, airports, subway stations and high traffic public places.

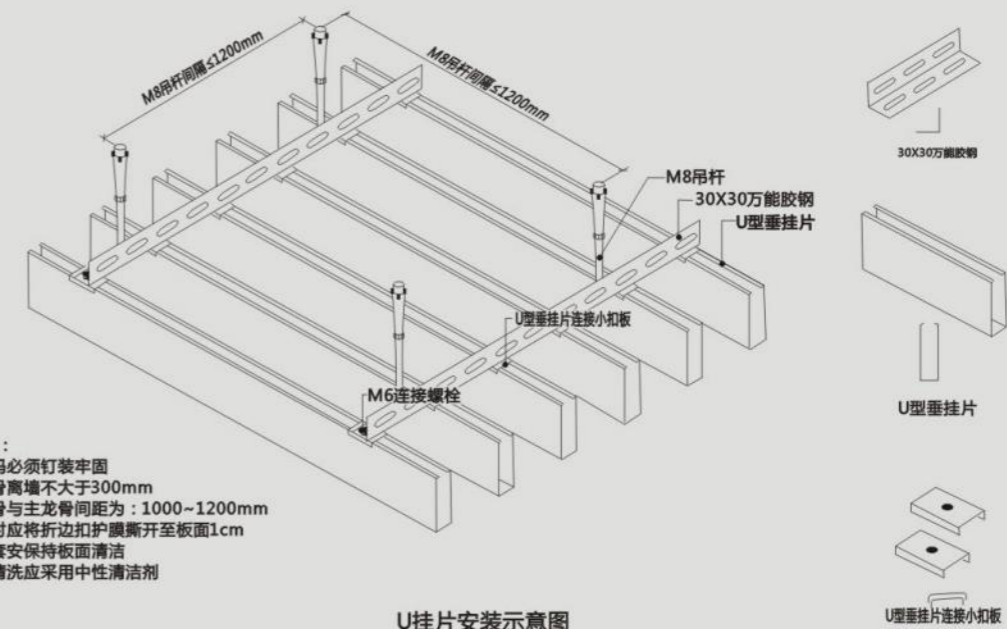

- 安装要求：
- 1、吸顶码必须钉装牢固
 - 2、主龙骨离墙不大于300mm
 - 3、主龙骨与主龙骨间距为：1000~1200mm
 - 4、安装时应将折边扣护膜撕开至板面1cm
 - 5、戴手套安装保持板面清洁
 - 6、板面清洗应采用中性清洁剂

U挂片安装示意图

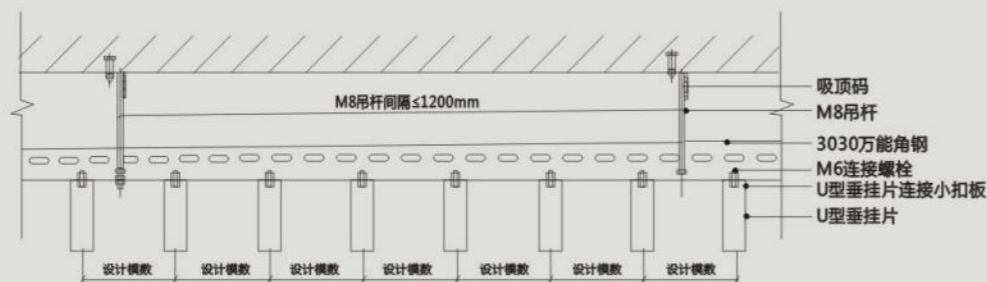

U型挂片横向剖面



U型挂片纵向剖面



SUSPENDED CEILING

格栅吊顶天花 Cell & Grid ceiling

格栅天花是由一个个小方格组合而成，它畅透式的空间给人一种强烈立体感观。格栅常规格为(mm): 100X100、150X150、200X200、250X250等

基材主要采用优质3003铝合金板，厚度为0.5~0.7mm，表面通过铬化处理再经过喷涂或辊涂而成。

使用区域：主要应用于大堂、机场、地铁站等。

Ceiling grid is a combination of small squares, through the type of space it gives Chang a strong three-dimensional feel.

Regular grid specification (mm): 100X100, 150X150, 200X200, 250X250 etc. Substrate mainly made of high quality 3003 aluminum alloy sheet, thickness 0.5 ~ 0.7mm, the surface treatment through the chrome and then by Made over spray or roller.

Use area: mainly used in lobbies, airports, subway stations.

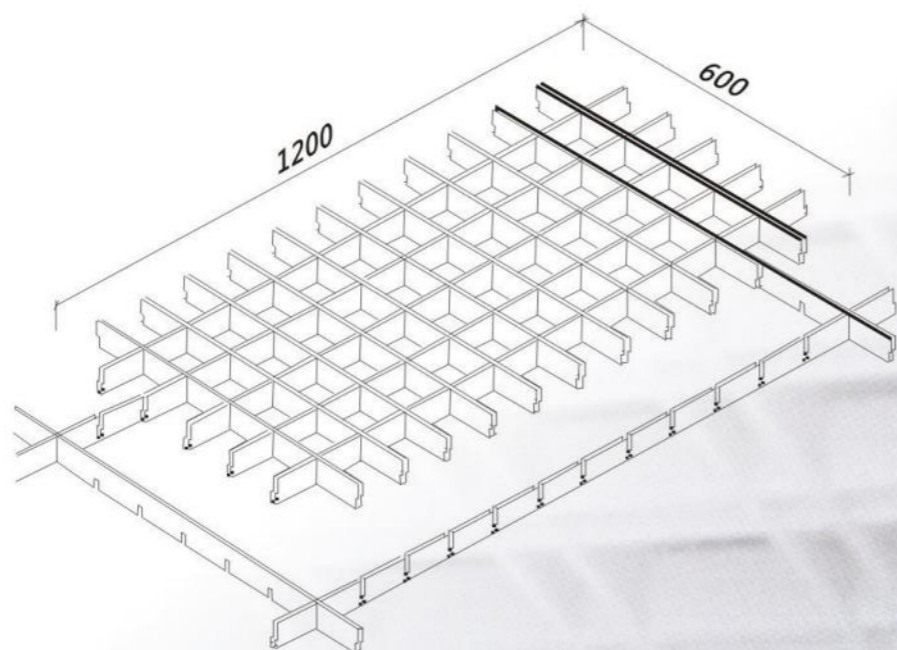

GSI、GSII系列格栅天花：

材料：由0.5mm铝合金加工制造
截面：

构成：由1200mm主骨(A骨)、600mm(B骨)
组成模块重复构造而成

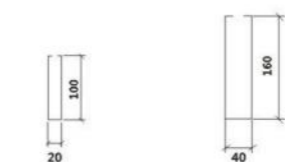

GSI型格栅截面

GSII型格栅截面

规格：

一、GSI型：75X75
100X100
150X150
200X200

二、GSII型：100X100
150X150
200X200
300X300

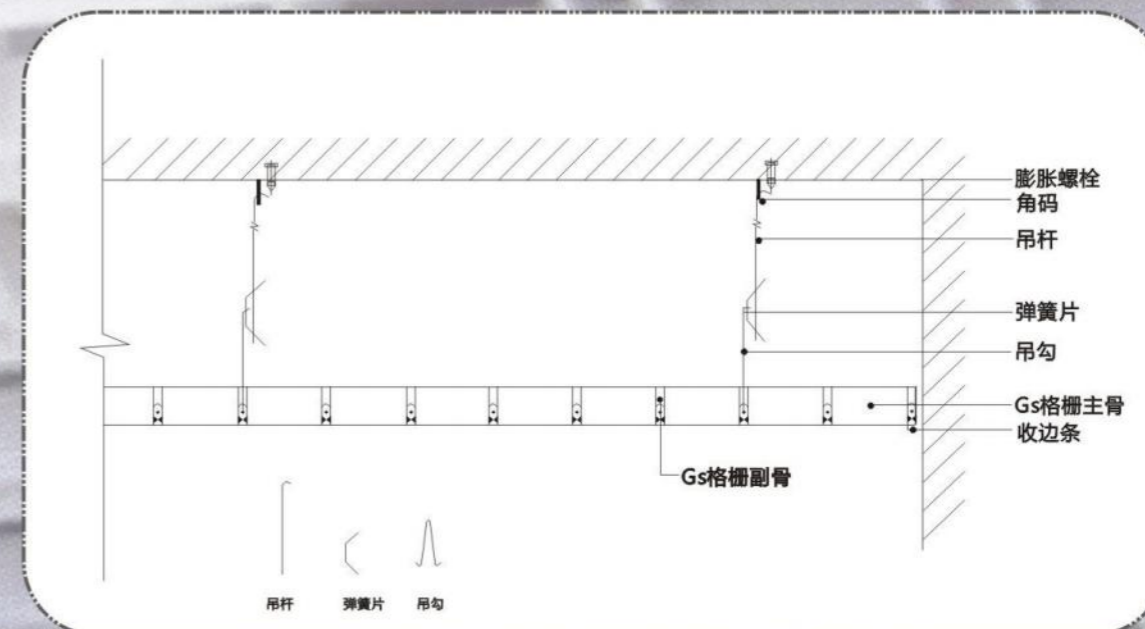

SUSPENDED CEILING

组合造型吊顶天花 Portfolio Sculpture Suspended Ceiling

组合天花是由天花板骨槽和天花板一起拼装而成，可以根据设计拼装成任何图案或客户可根据各自爱好随意组合，颜色任意搭配，充分发挥个人想象力，展现不同风格。

基材主要采用优质3003铝合金板，厚度为0.7~3.0mm，表面通过铬化处理再经过喷涂或辊涂而成。

使用区域：主要应用于厅、堂、宾馆、酒店、商场等场所。

Smallpox is a combination of tank and ceiling with ceiling bone held together, according to Assembled in any pattern or design clients can be freely combined according to their hobbies, any color With fully develop their imagination, to show different styles.

Substrate mainly made of high quality 3003 aluminum alloy sheet, thickness 0.7 ~ 3.0mm, the surface After chromium treatment by spray or roller and then made.

Use area: mainly used in hall, hall, hotel, hotels, shopping malls and other places.

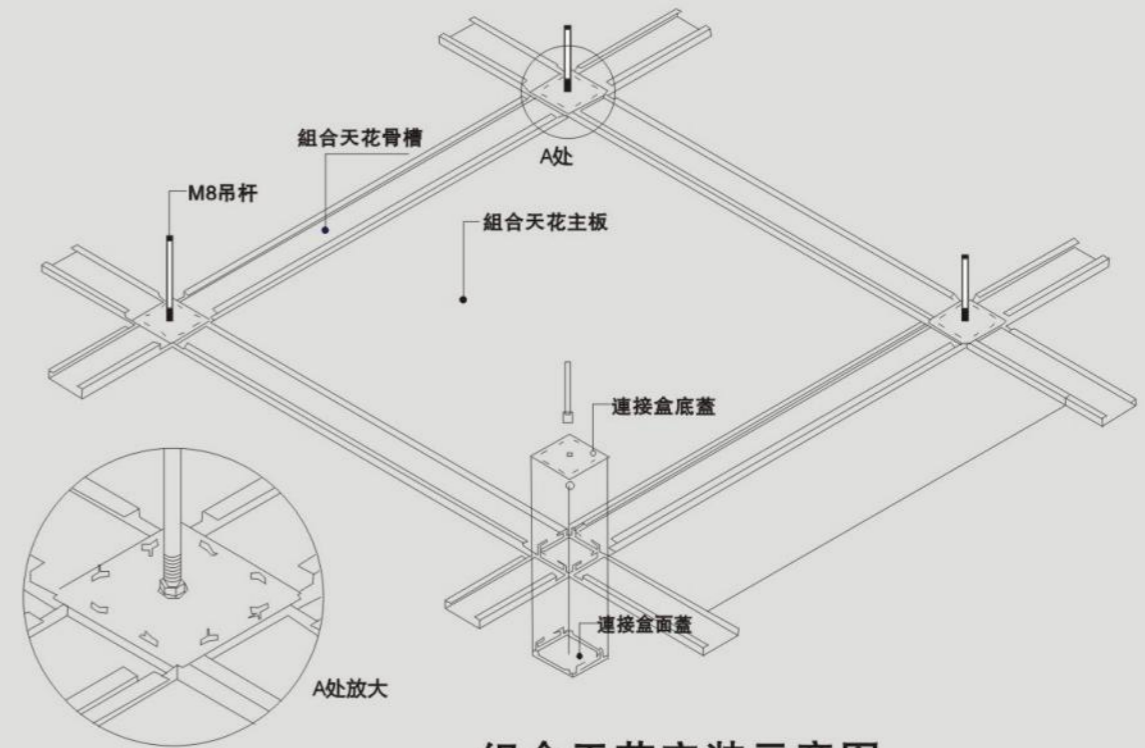

组合天花安装示意图

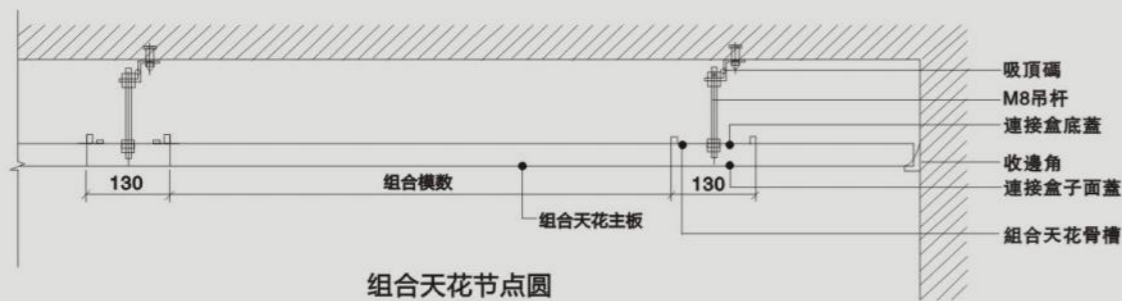

组合天花节点图

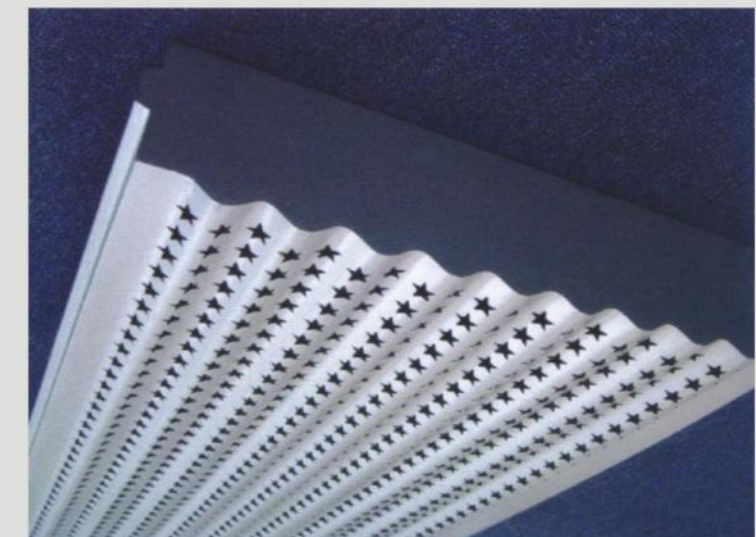

SUSPENDED CEILING

网孔天花 Mesh Ceiling

网孔天花板是众多天花当中的新宠儿，它以独特的风格给人一种犹抱琵琶半遮面样朦胧美而迅速赢得众多消费者的青睐。无论你站在任何一个角度，他都能给你一个全新的视觉感观，让你无法触摸他真面目。在主流高档建筑物当中总少不了网孔天花的身影。

基材主要采用优质3003铝合金板，厚度为1.5~3.0mm,表面通过铬化处理再经过喷涂而成。使用区域：主要应用于厅、堂、宾馆、酒店、商场、候机楼、车站等场所。

Mesh ceiling and the ceiling of which is the new darling of many, it gives us a unique style Still holds partly concealed like hazy beauty quickly won the favor of many consumers. Whether you're standing Any one point, point, he will give you a new visual look and feel so real you can not touch him Face. Among high-grade buildings in the mainstream will always mesh ceiling figure.

Mainly high-quality 3003 aluminum alloy substrate plate, thickness 1.5 ~ 3.0mm, the surface through After spraying of chromium from processing further. Use area: mainly used in hall, hall, hotel, wine Stores, shopping malls, terminals, stations and other places

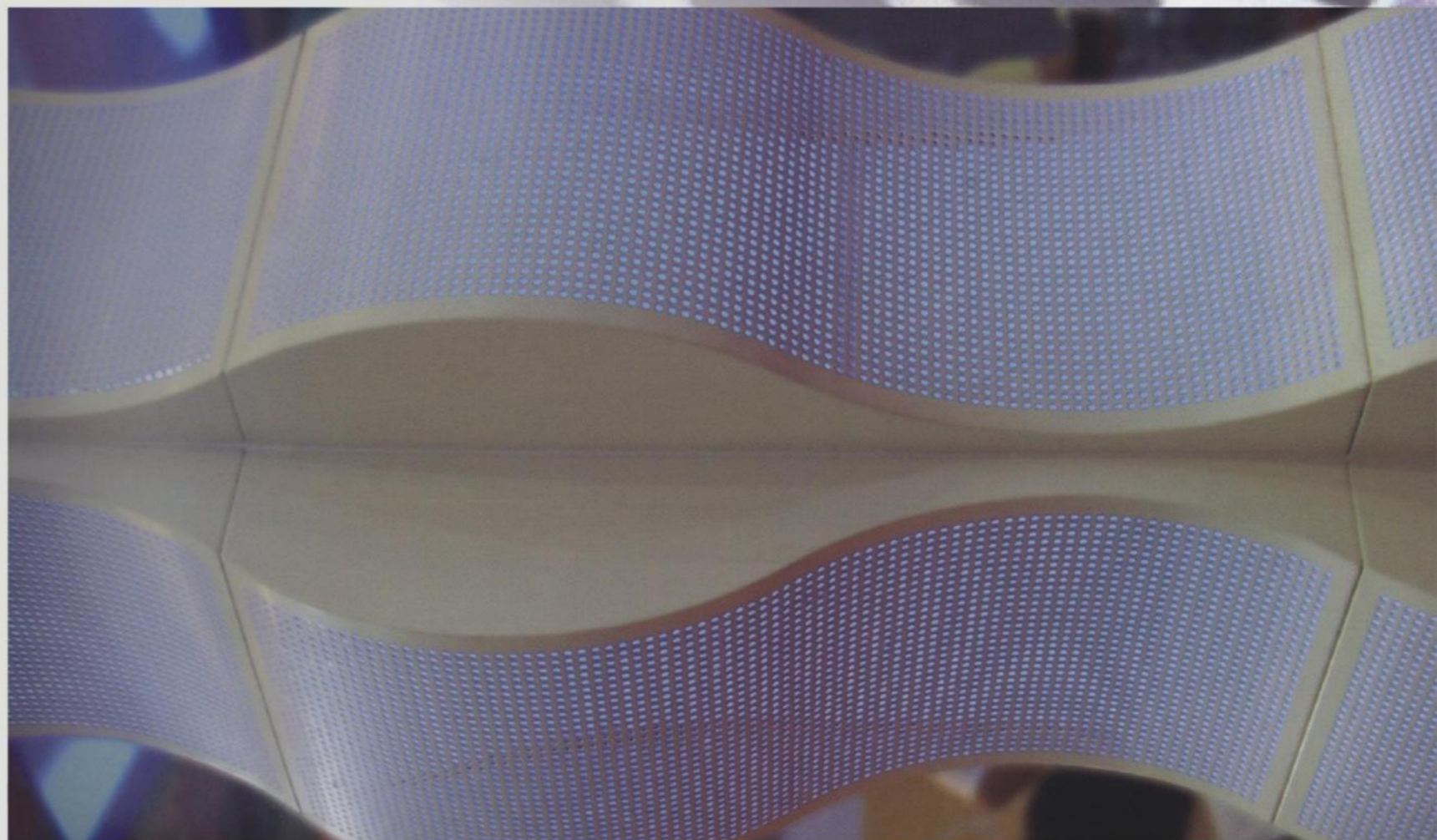

我们永不懈怠 追求更大的成功……

TYPICAL PROJECT

AWARD-WINNING PROJECT
获奖工程



东元国际
INTDERNATIONAL

TYPICAL DOMESTIC PROJECT
国内典型工程

TYPICAL PROJECT

我们永不懈怠 追求更大的成功



TYPICAL DOMESTIC PROJECT
国内典型工程

TYPICAL PROJECT

我们永不懈怠 追求更大的成功



TYPICAL DOMESTIC PROJECT
国内典型工程

TYPICAL PROJECT

我们永不懈怠 追求更大的成功



东元国际
INTDERNATIONAL



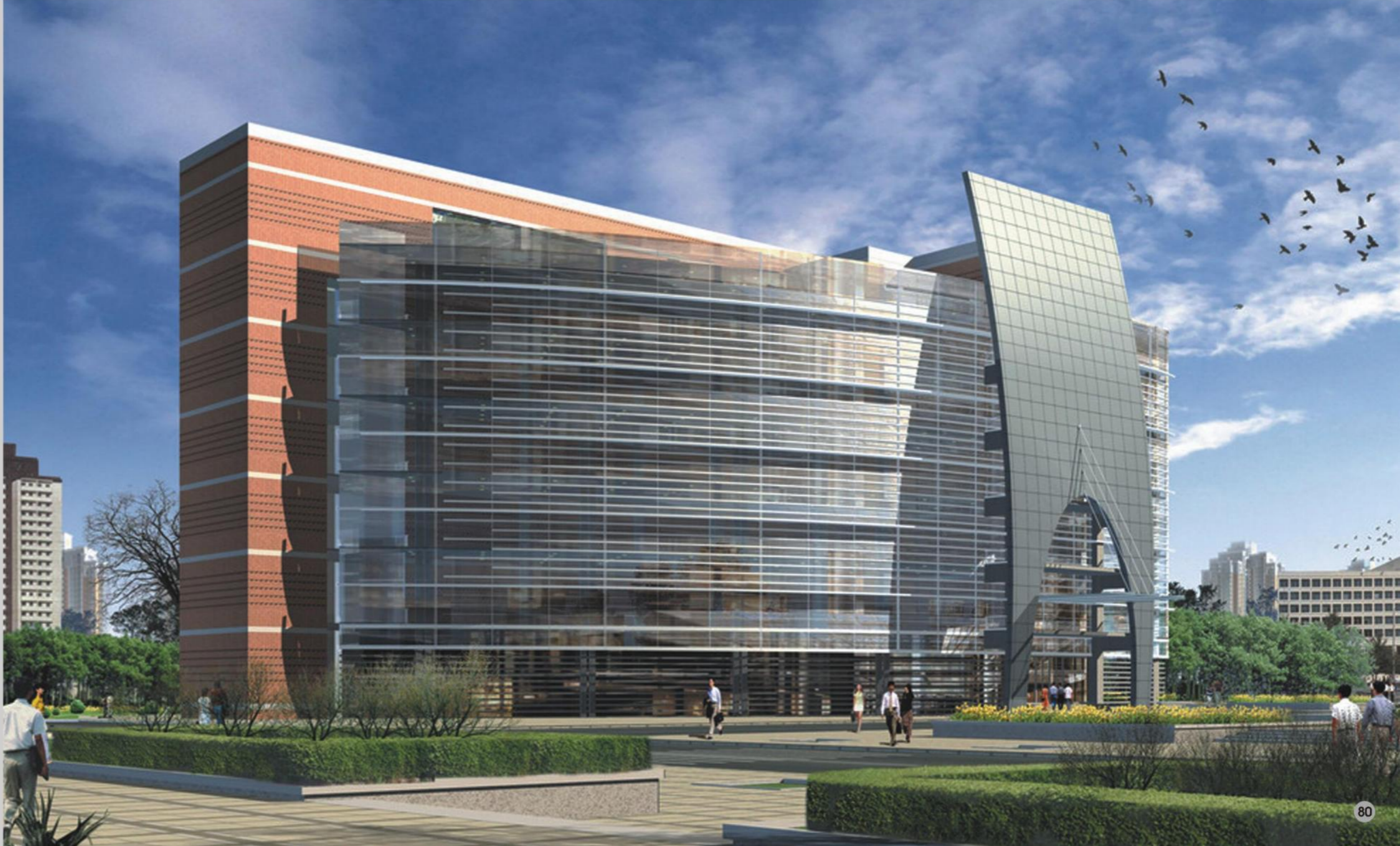
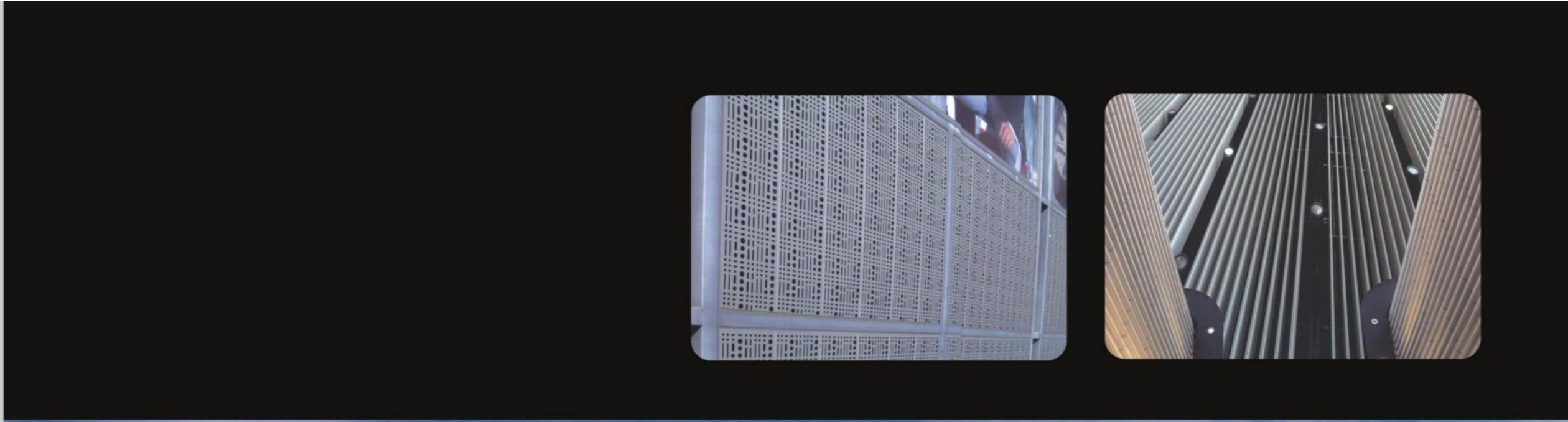

TYPICAL DOMESTIC PROJECT

国内典型工程

TYPICAL PROJECT

我们永不懈怠 追求更大的成功……



TYPICAL DOMESTIC PROJECT
国内典型工程

TYPICAL PROJECT

我们永不懈怠 追求更大的成功……



TYPICAL PROJECTS ABROAD 国外典型工程

TYPICAL PROJECT

我们永不懈怠 追求更大的成功……



东元国际
INTDERNATIONAL



TYPICAL PROJECT

TYPICAL PROJECTS ABROAD
国外典型工程

我们永不懈怠 追求更大的成功……



东元国际
INTDERNATIONAL



TYPICAL PROJECTS ABROAD
国外典型工程

TYPICAL PROJECT

我们永不懈怠 追求更大的成功……

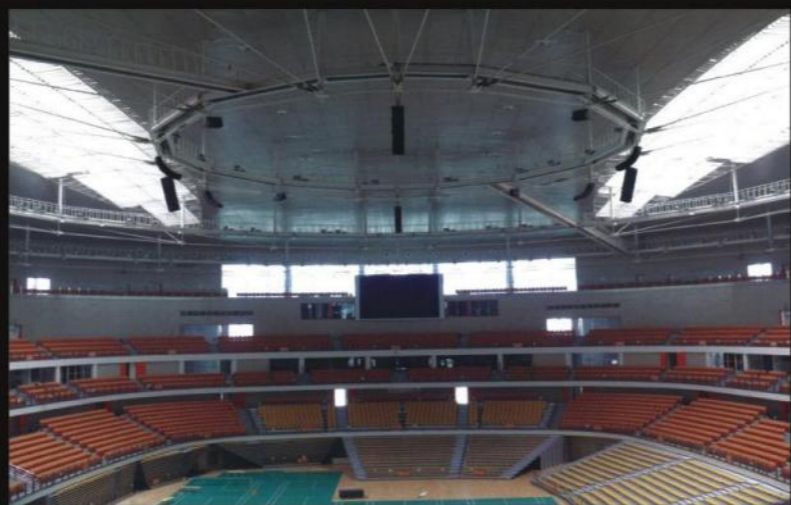

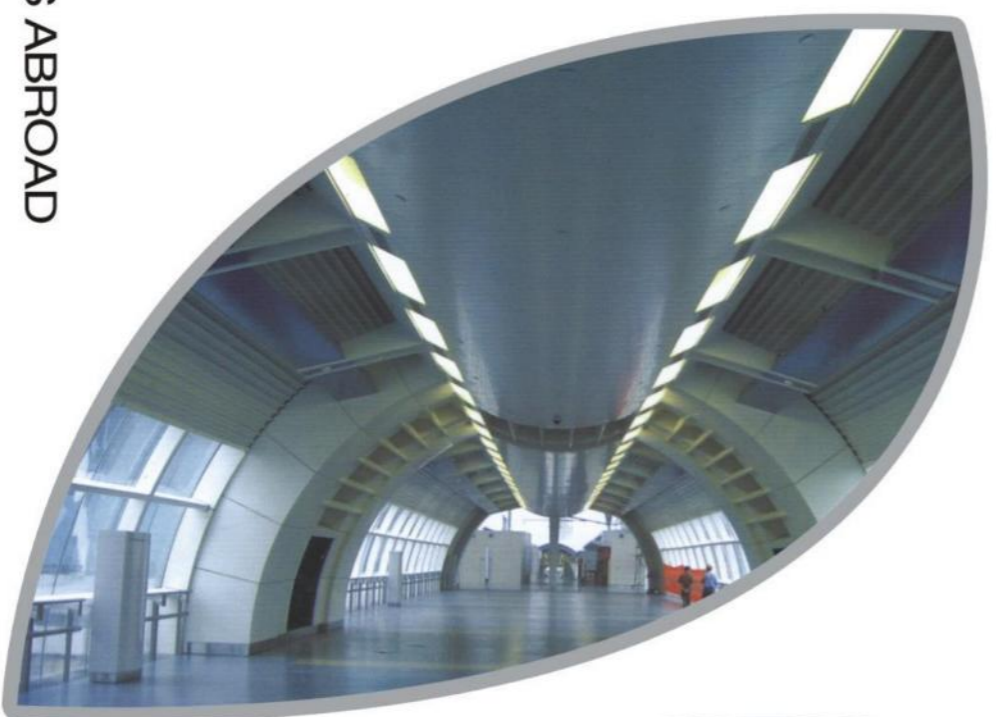

TYPICAL PROJECTS ABROAD
国外典型工程

TYPICAL PROJECT

我们永不懈怠 追求更大的成功……