



东元国际
INTERNATIONAL

ALUMINUM CEILING &
ALUMINUM WALL PANEL



WORKSHOP

The producing technology is the power of an enterprise, advanced technology will make enterprise stronger.

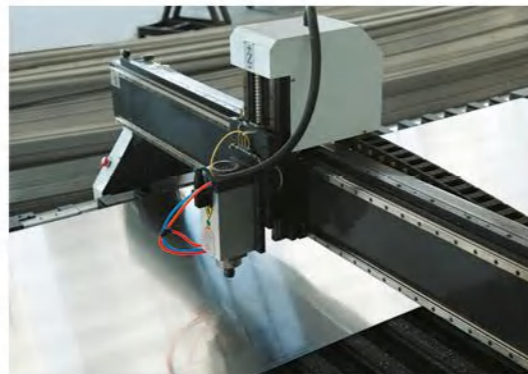

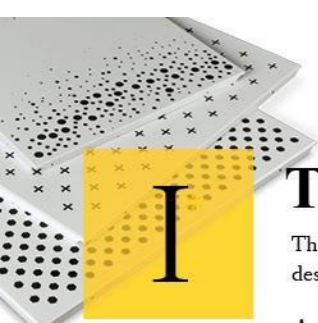

THE UPDATING CEILING SERIES

The 600*600 tiles had been used for 20+ yrs in the project, now multiple punching and profiling design(800*800、700*700)are developed. 400*1200,500*1300 ceilings are also available.

* The artistic punching series



Punching type available within 800*800mm、700*700mm、600*600mm tiles



YCCK-001

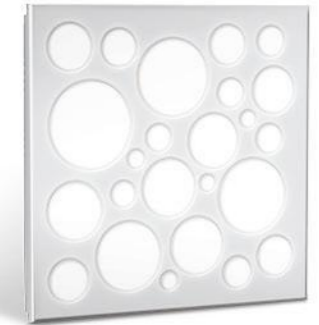
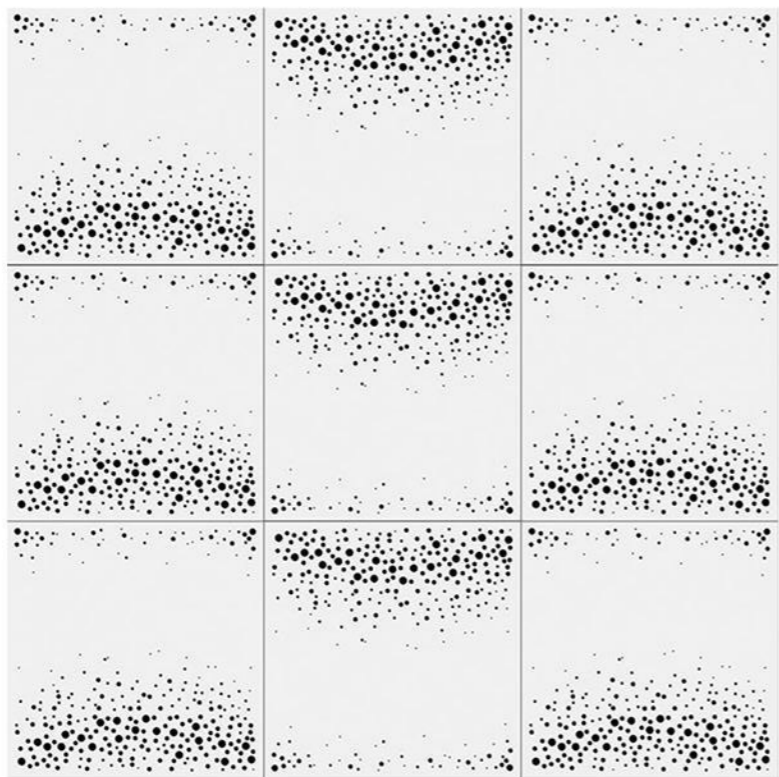

YCHD-001 (LED)



YCCK-003

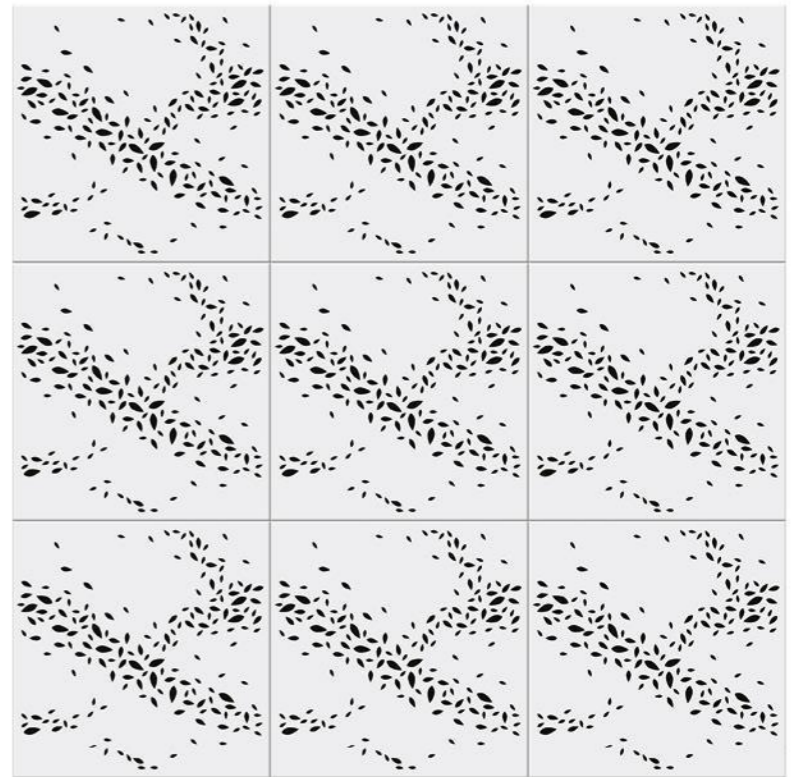

YCHD-003 (LED)



YCCK-002

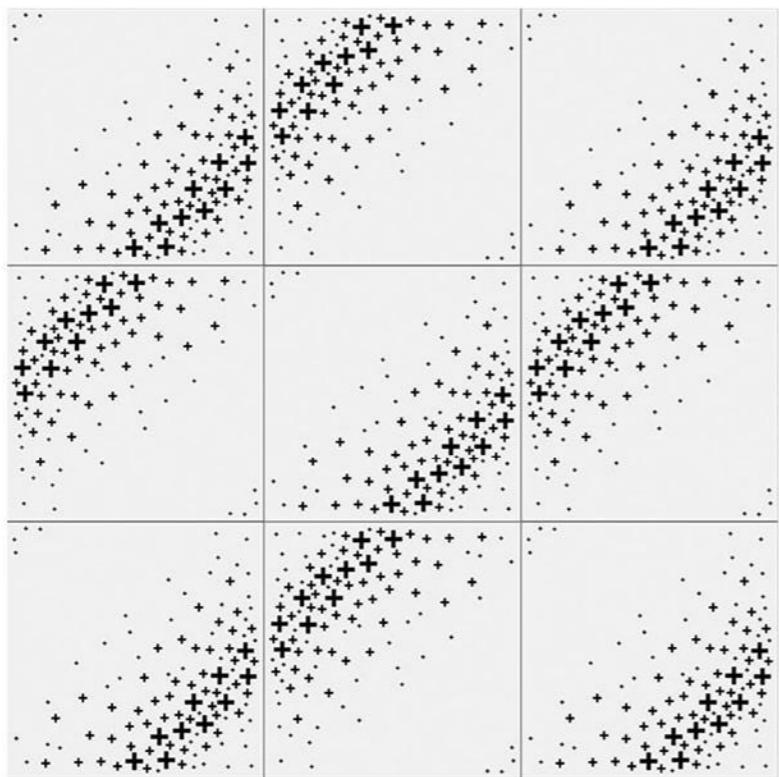

YCHD-002 (LED)



YCCK-004

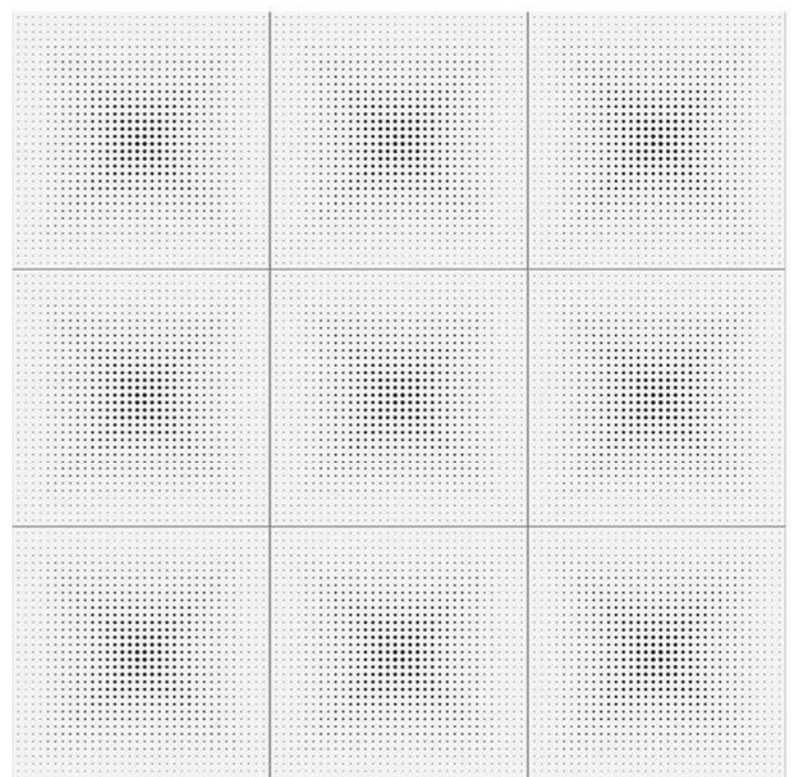

YCHD-004 (LED)

* The new punching series

Punching designs below are available within all square panel sizes

YCCK-005

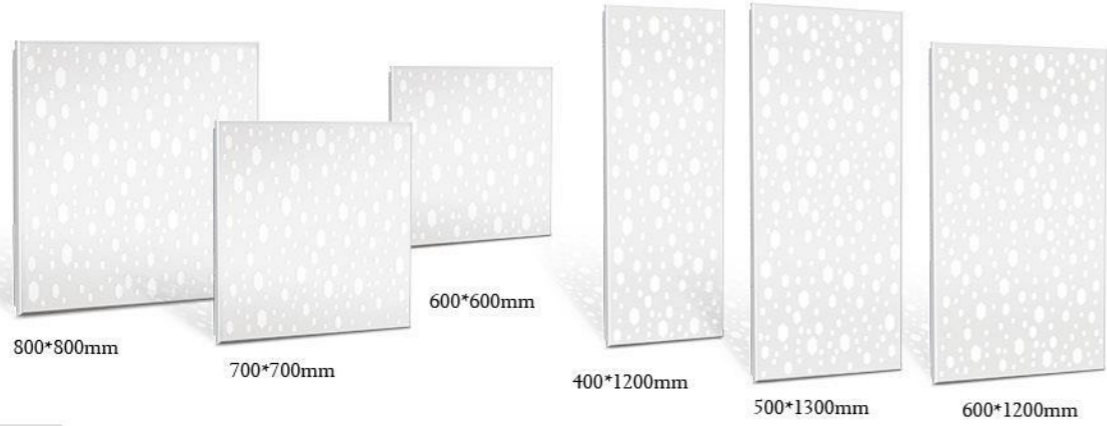

YCCK-007

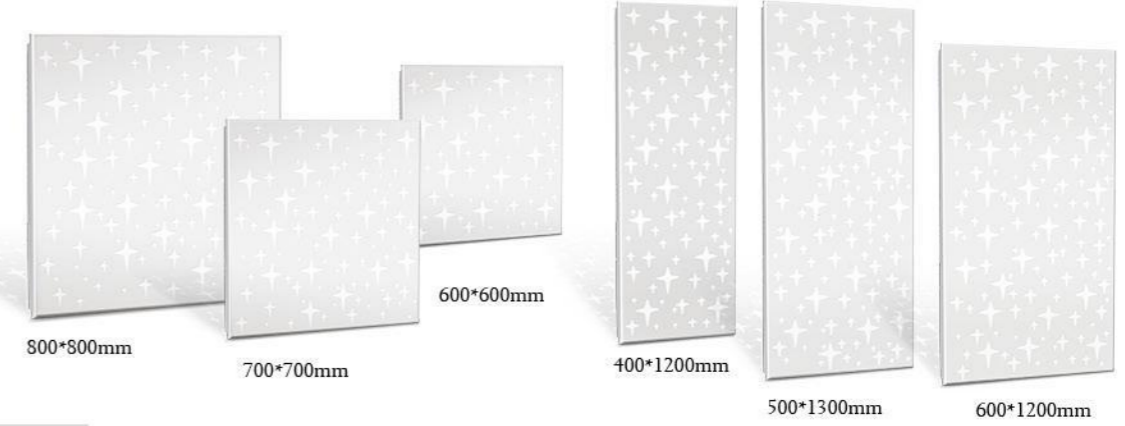

YCHD-005

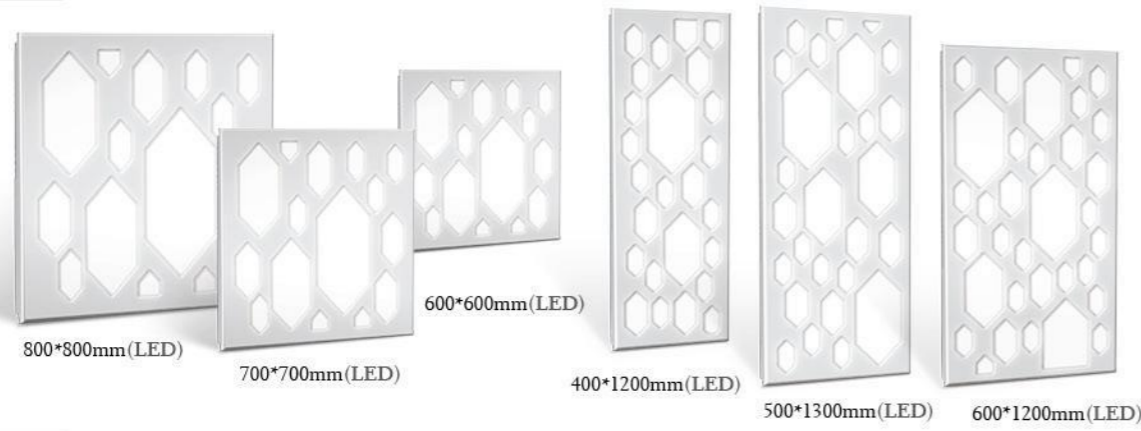

YCHD-007

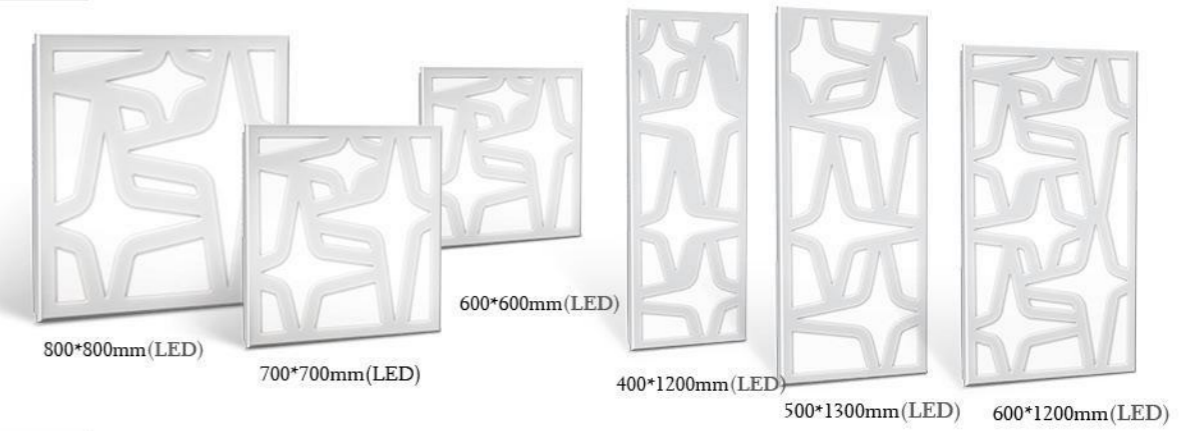

YCCK-006

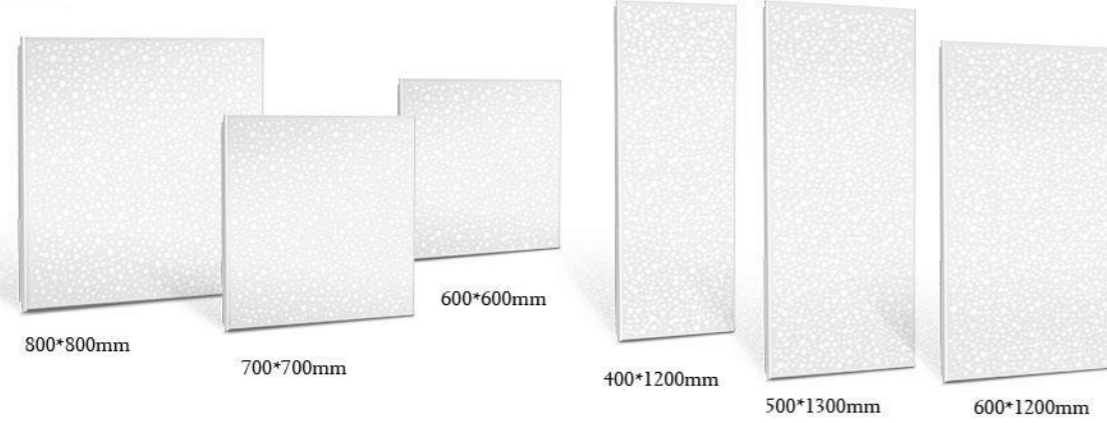

YCCK-008

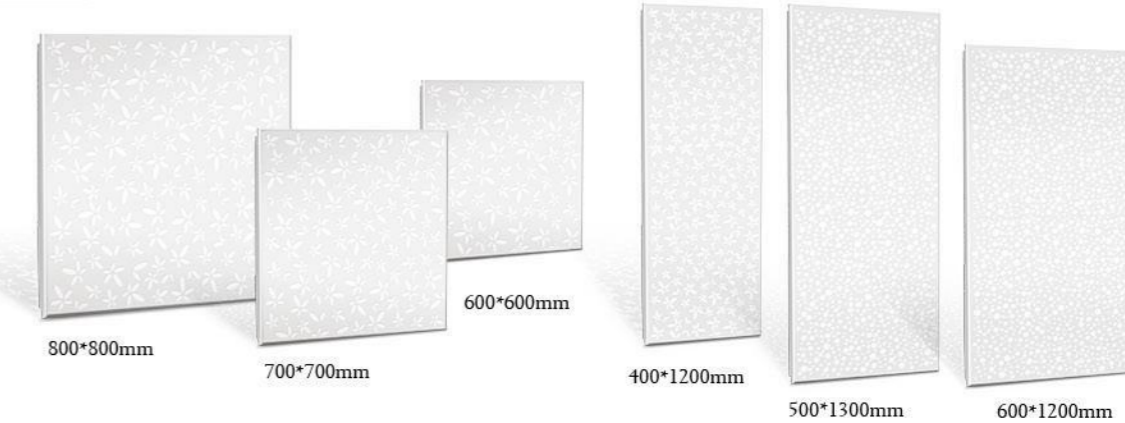

YCHD-006

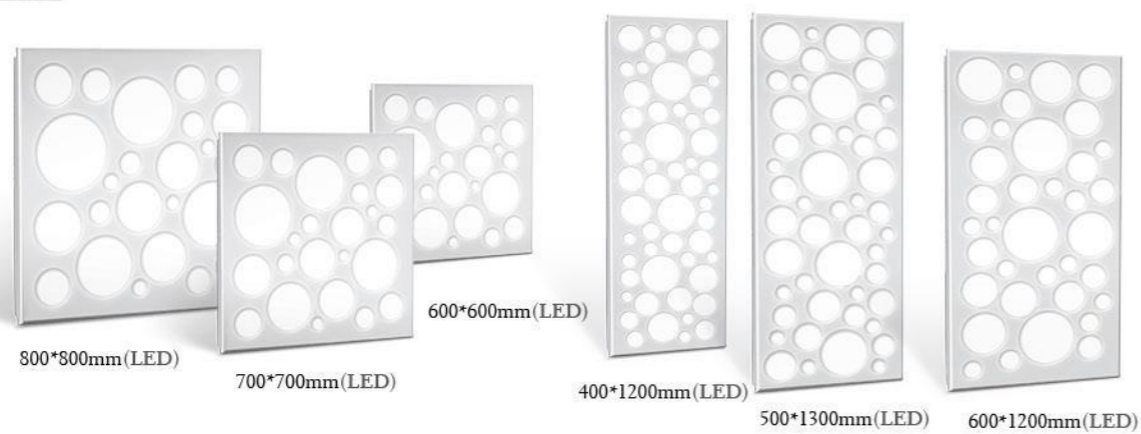

YCHD-008

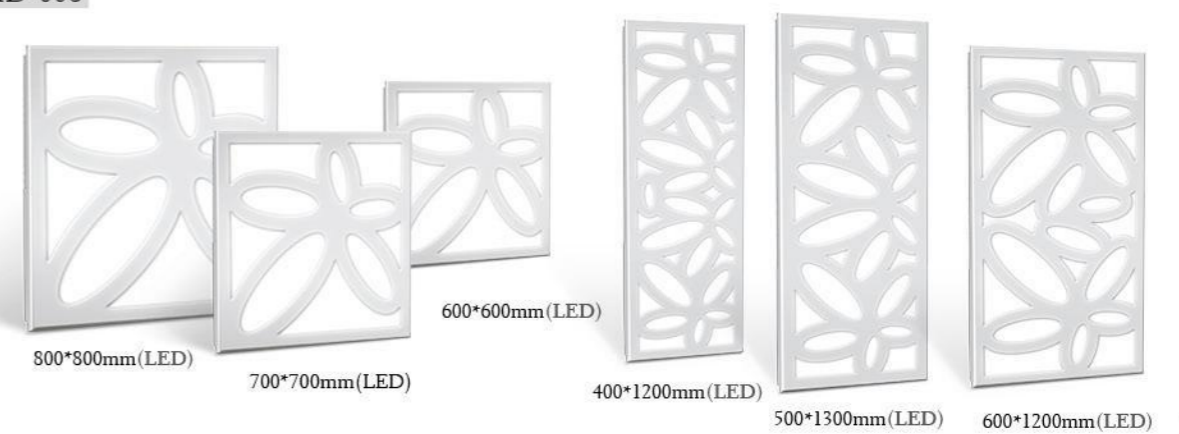



YCCK-009



YCCK-010

Four of the above products are matched with LED lights



YCCK-011



YCCK-012



YCHD-004 (LED)



YCCK-013



YCCK-014



YCCK-015



YCHD-009 (LED)



YCHD-010 (LED)



YCHD-011 (LED)

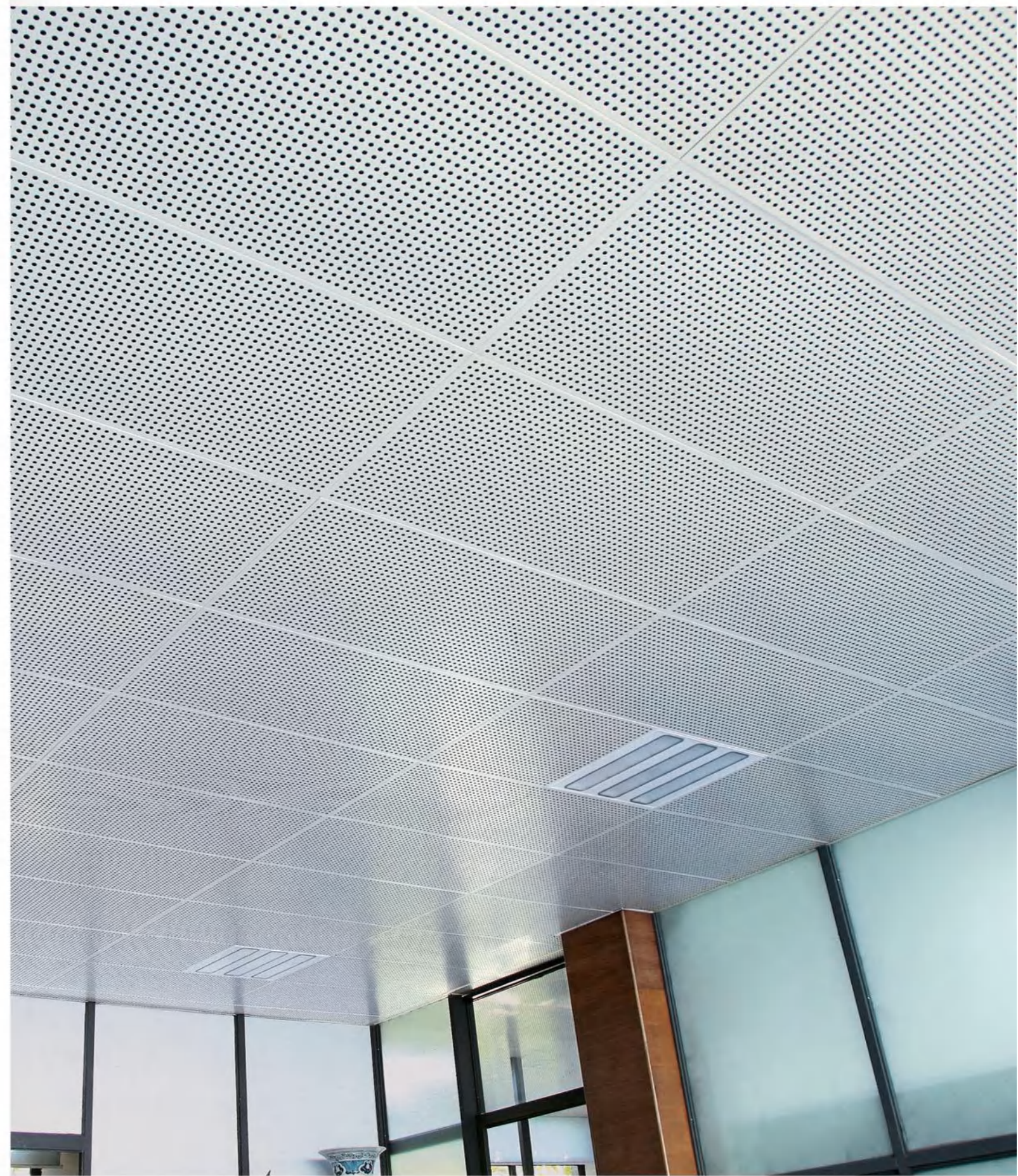



✦ The stereo punching series

Available within 800*800mm ceiling



LTCK-001



YCHD-012 (LED)

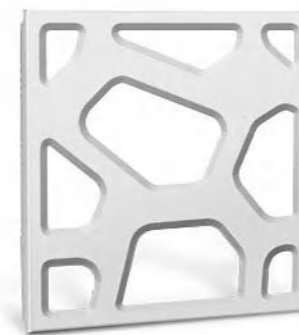
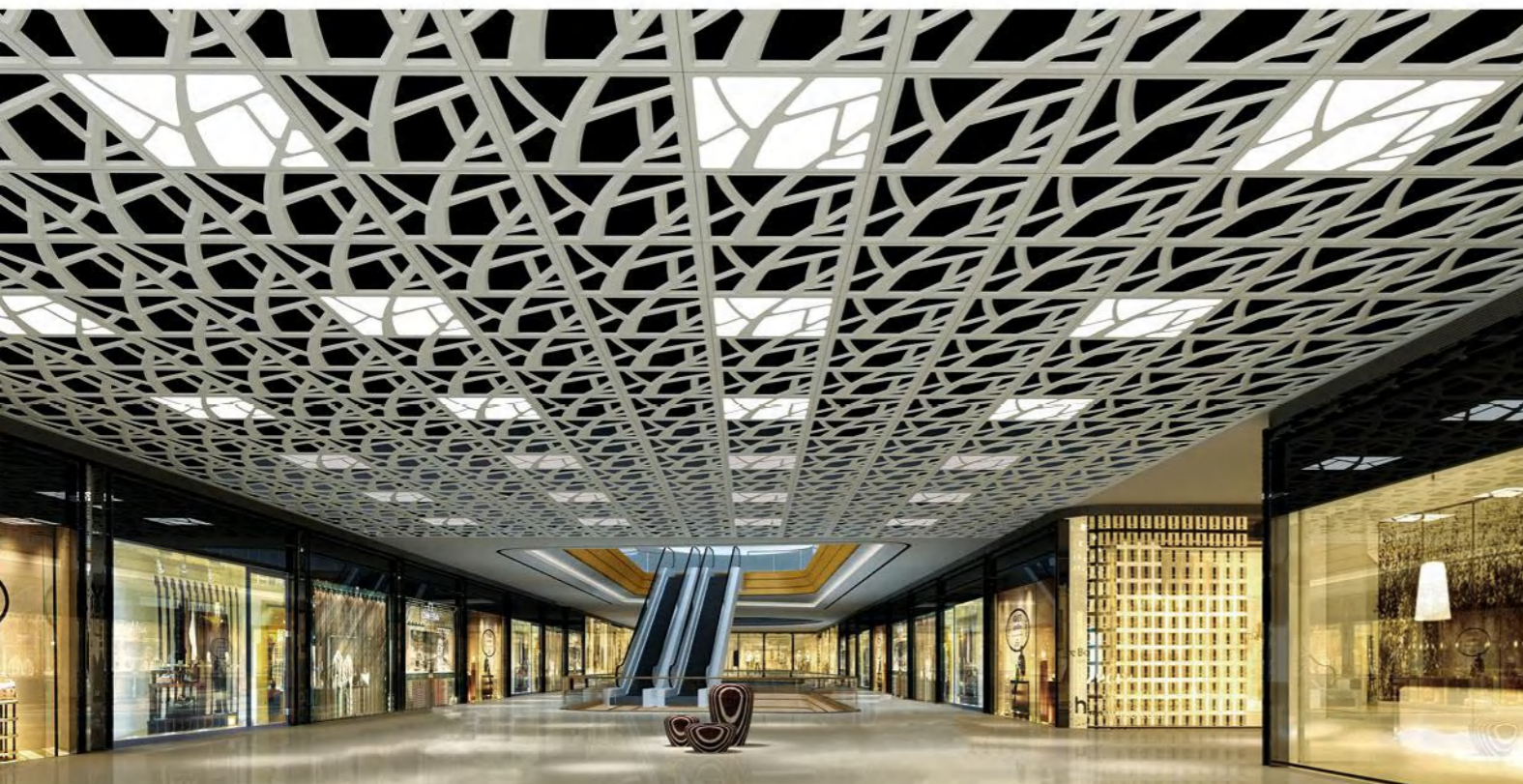
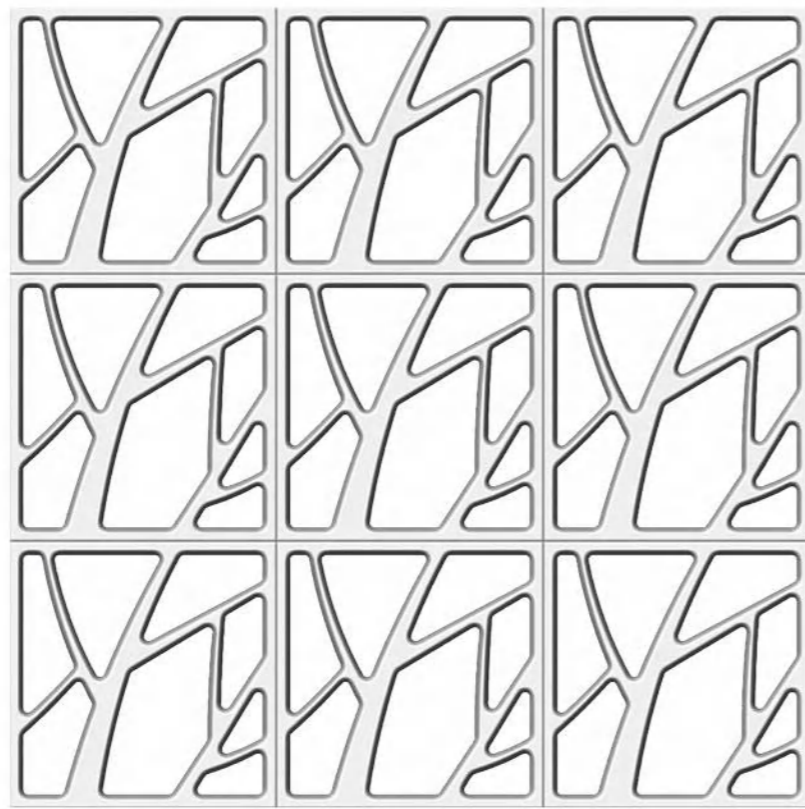

LTCK-002



YCHD-013 (LED)

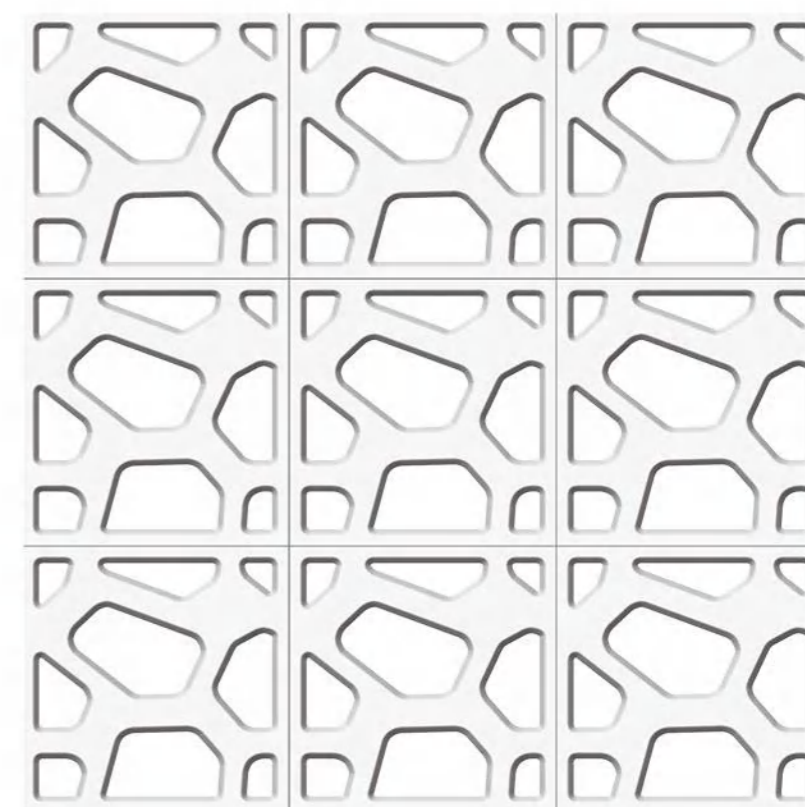



LTCK-003



YCHD-014 (LED)



LTCK-004



YCHD-015 (LED)

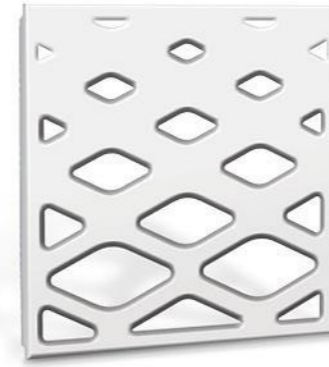
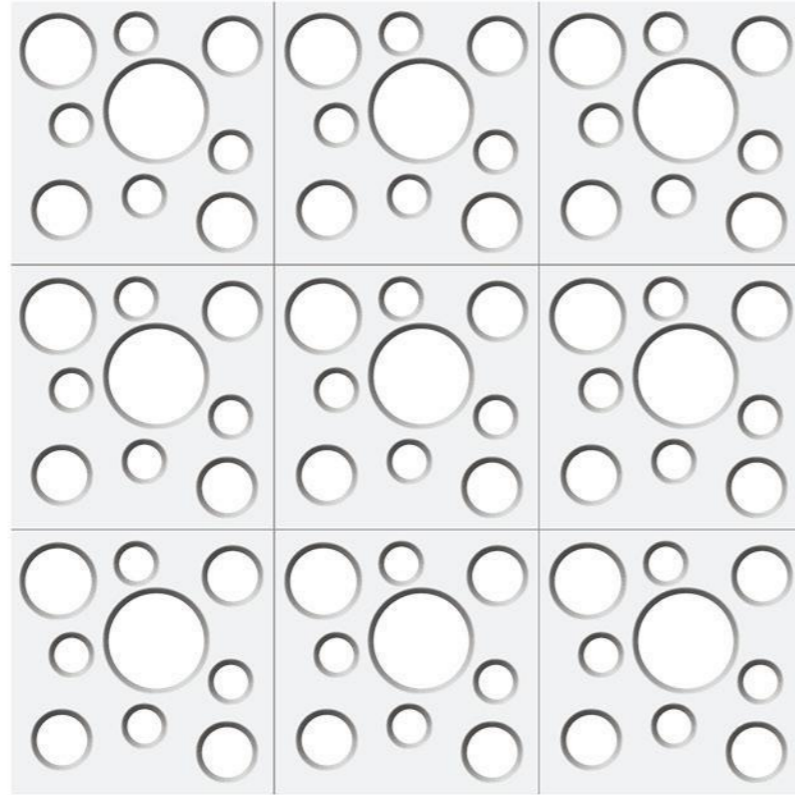

LTCK-005



YCHD-016 (LED)

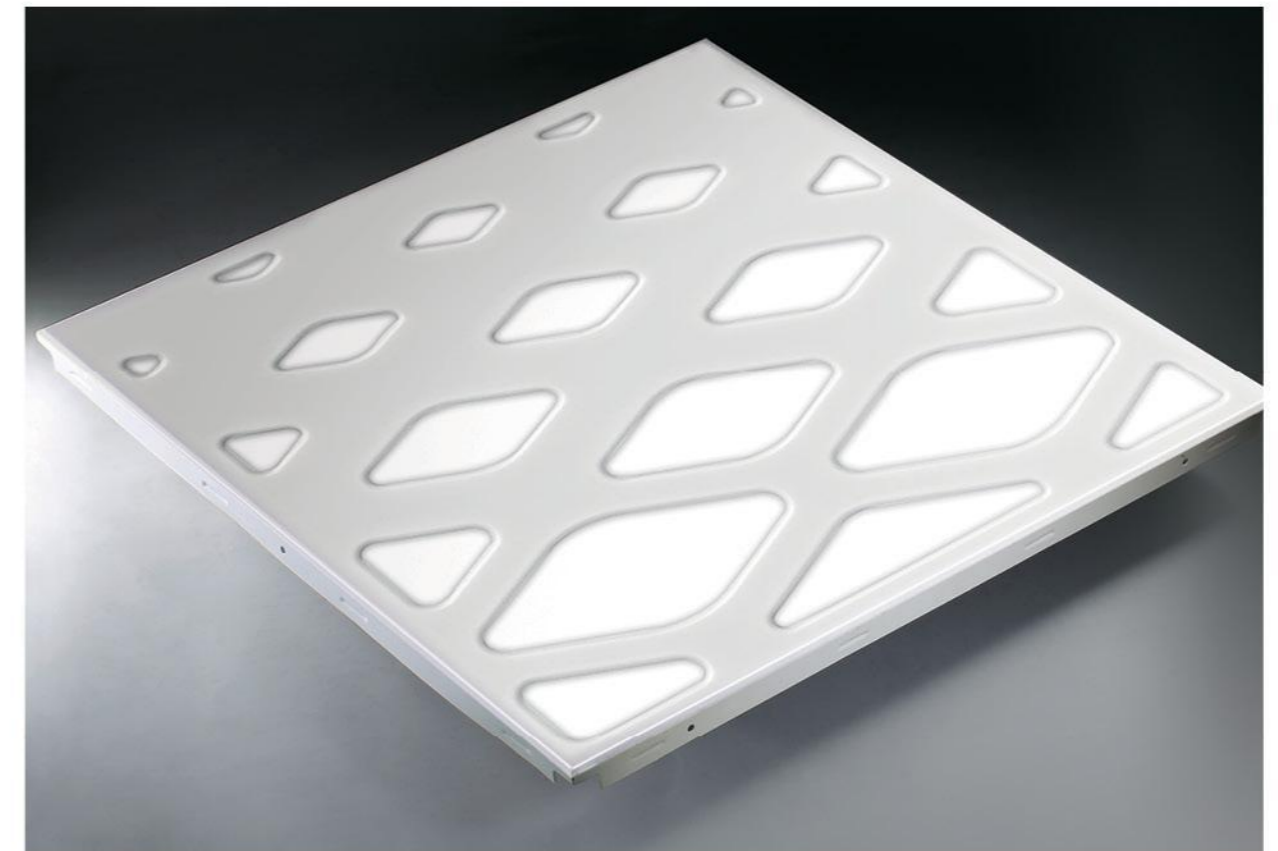
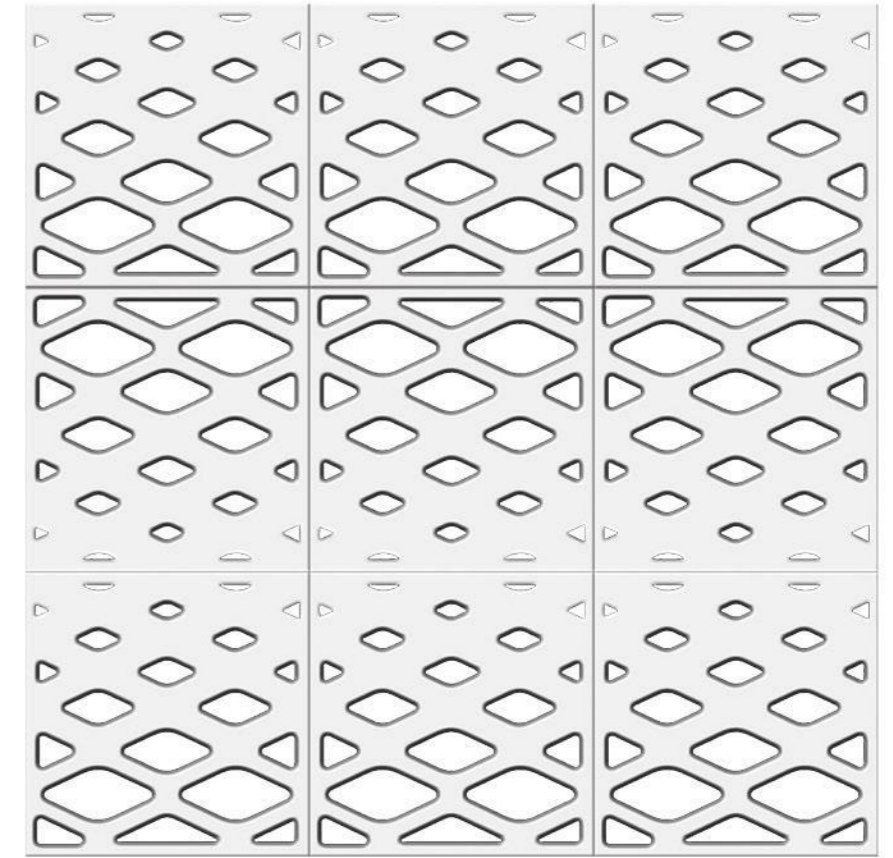

✦ The 3D profiling series

Available within 800mm*800mm 700mm*700mm 600mm*600mm



YCYX-001

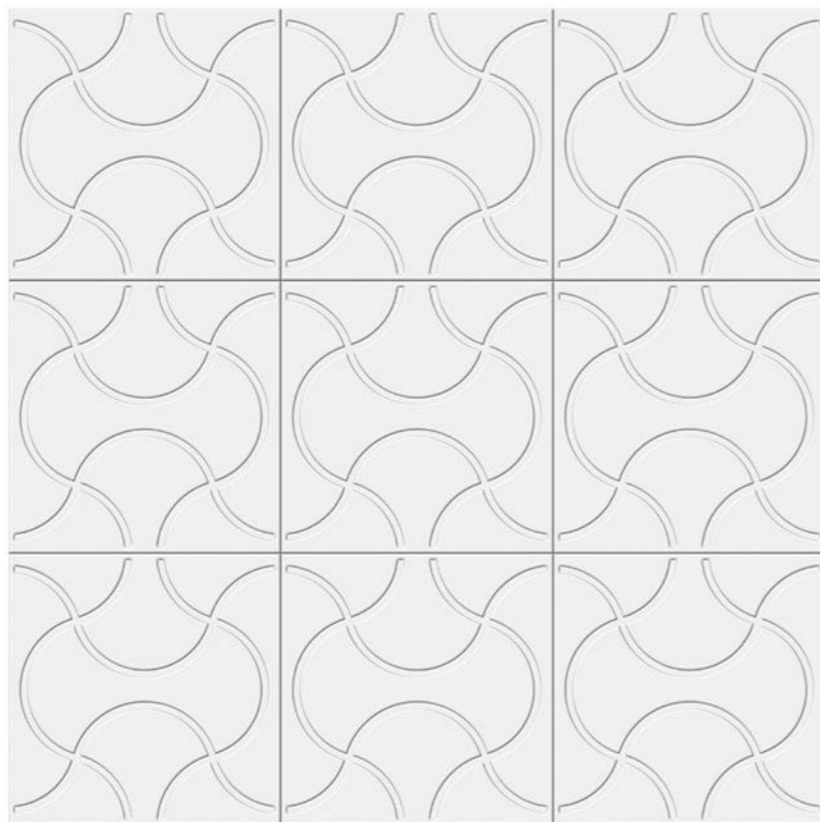

YCHD-017(LED)



YCYX-002

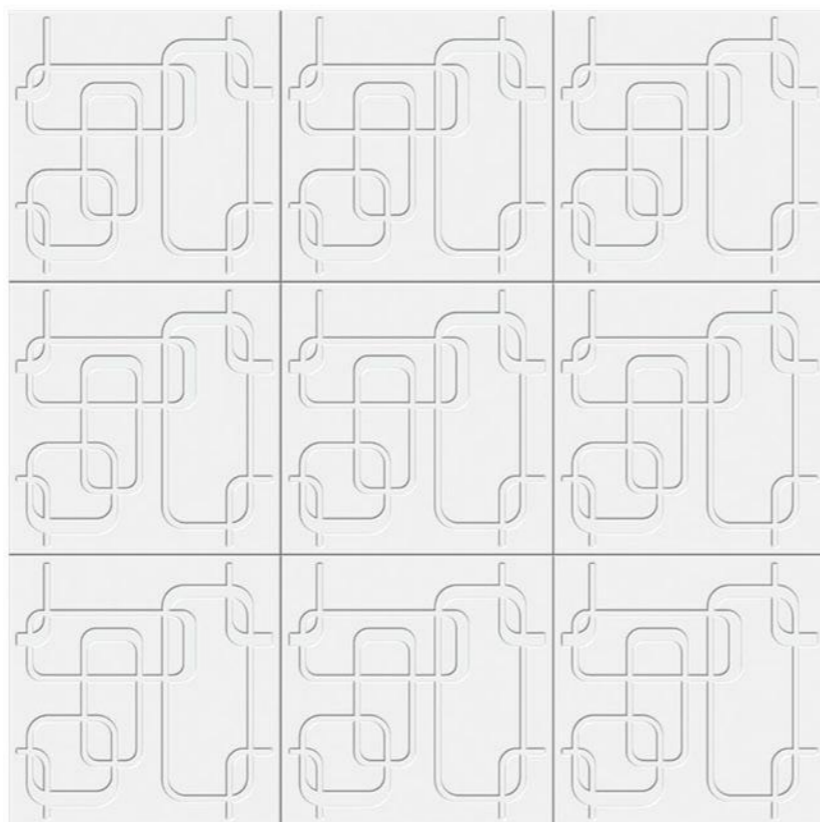

YCHD-018(LED)



YCYX-003

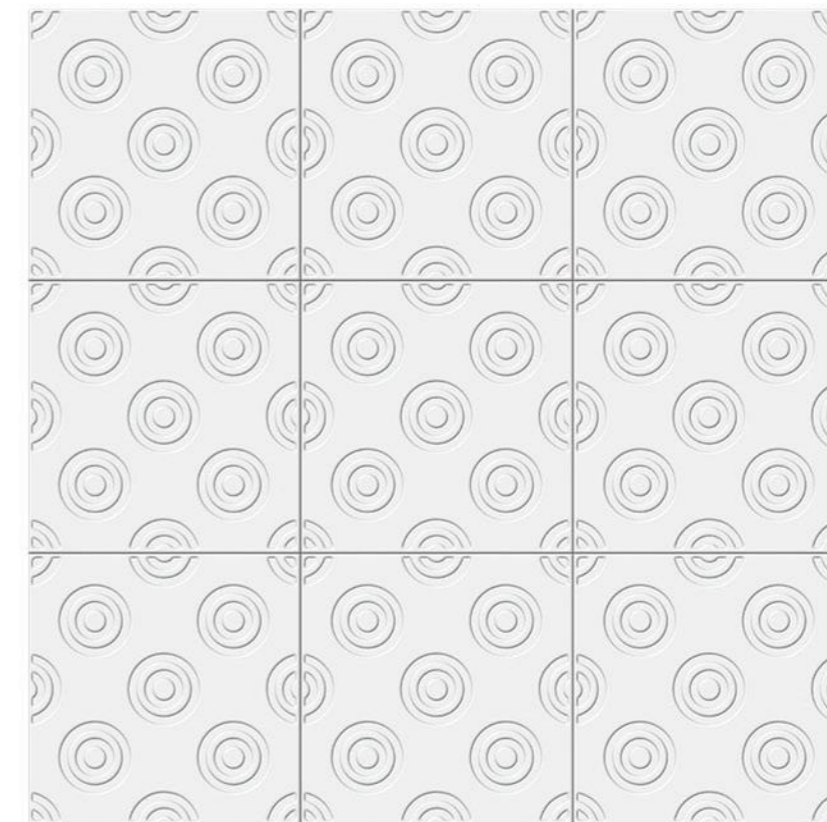

YCHD-019(LED)

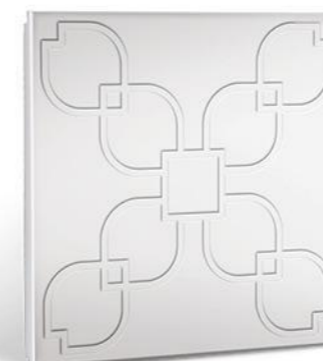

YCYX-004

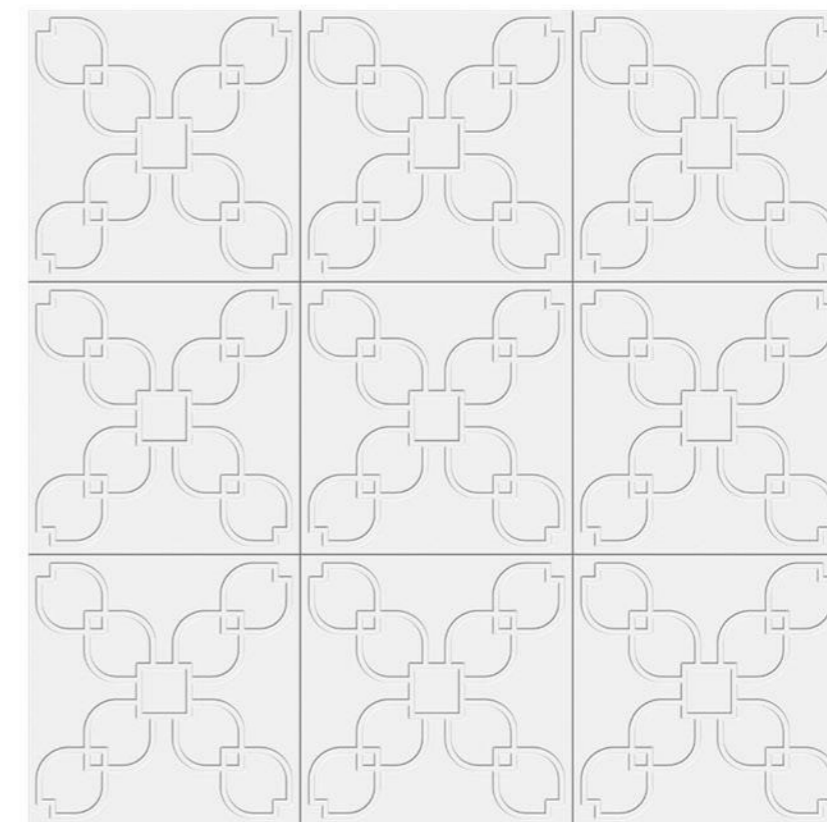

YCHD-020(LED)



YCYX-005

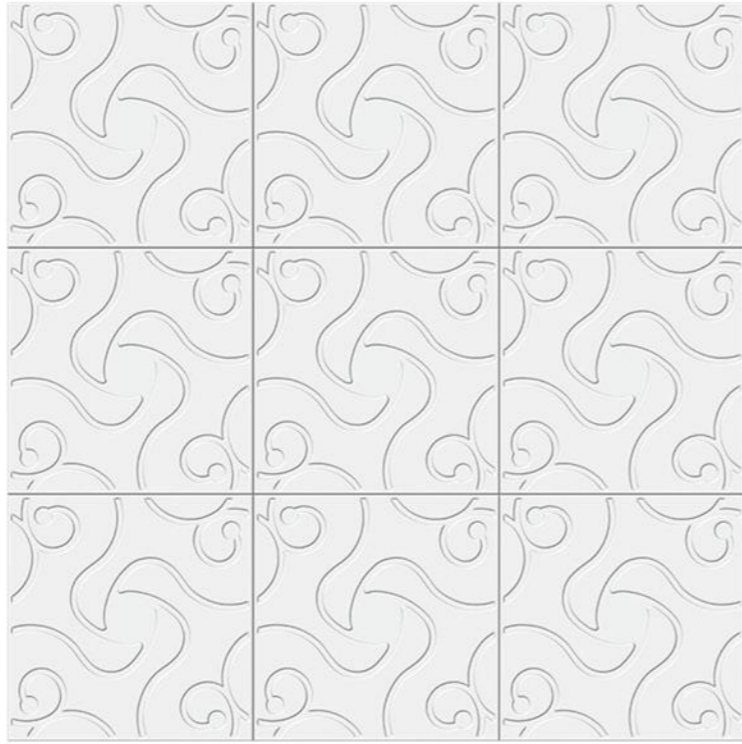

YCHD-021 (LED)

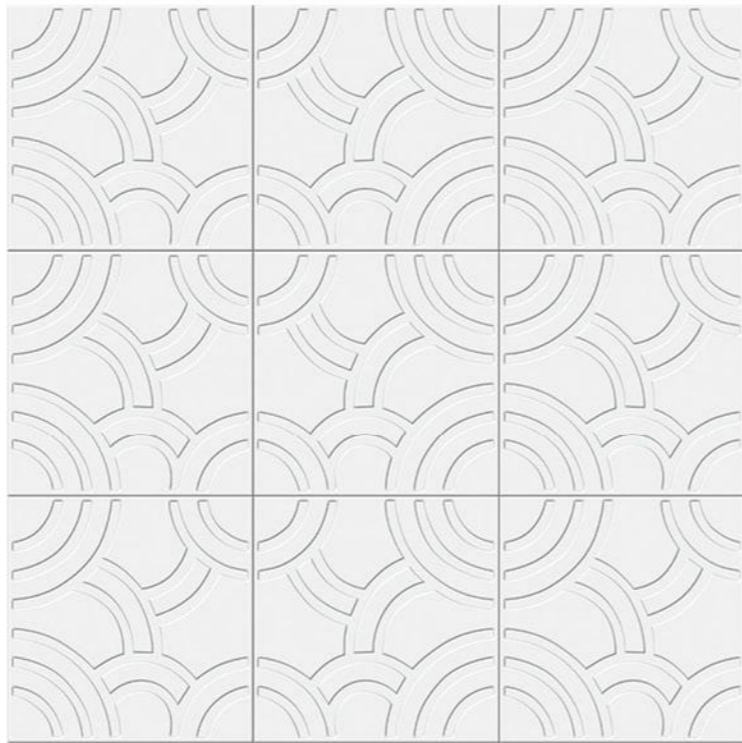

YCYX-006



YCHD-022 (LED)



YCYX-007

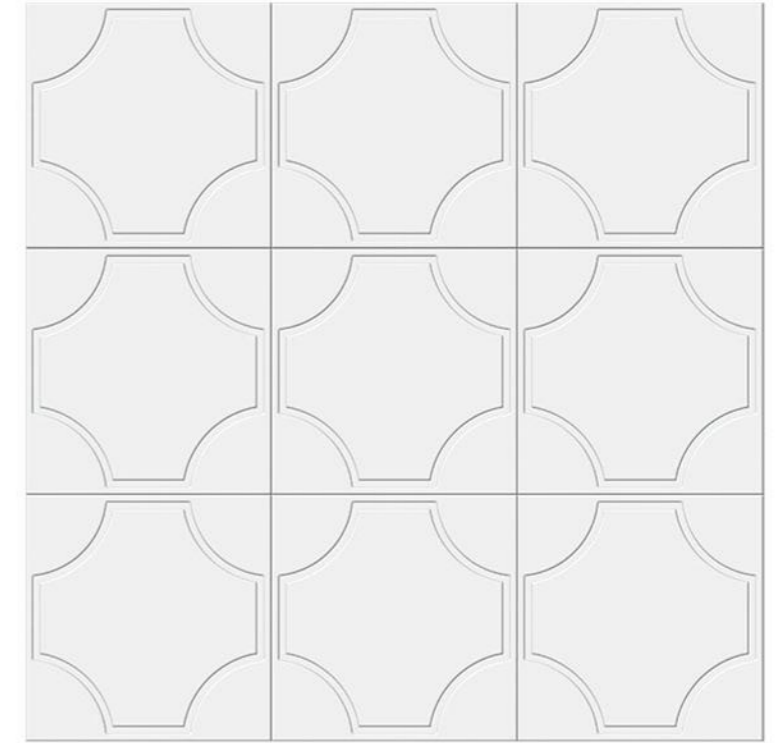

YCHD-023 (LED)



YCYX-008

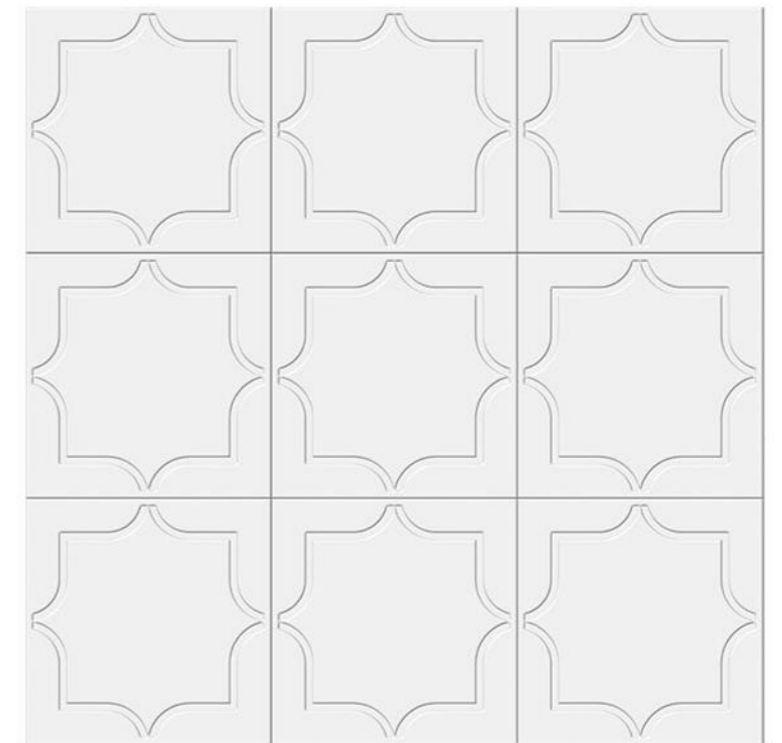

YCHD-024 (LED)



YCYX-009



YCHD-025 (LED)

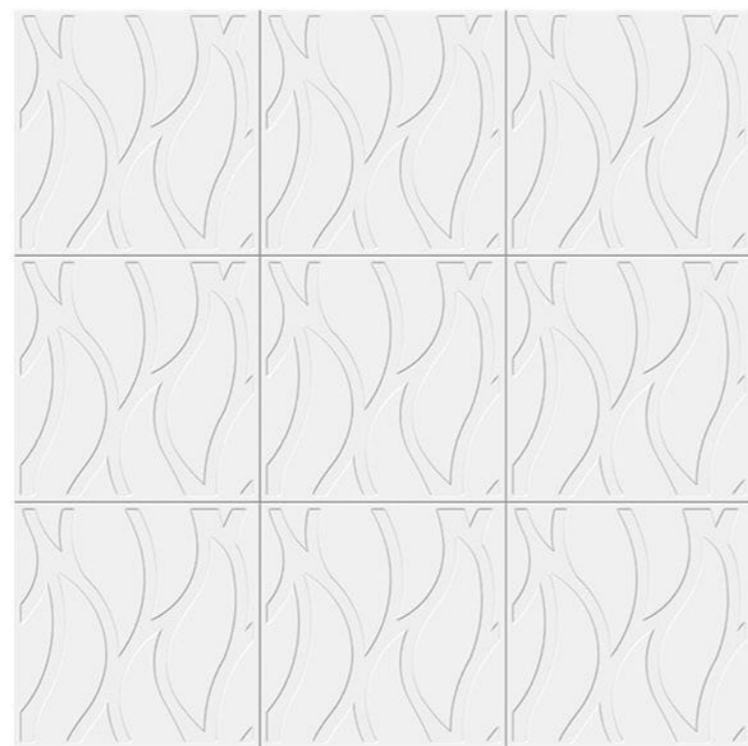

YCYX-010



YCHD-026(LED)

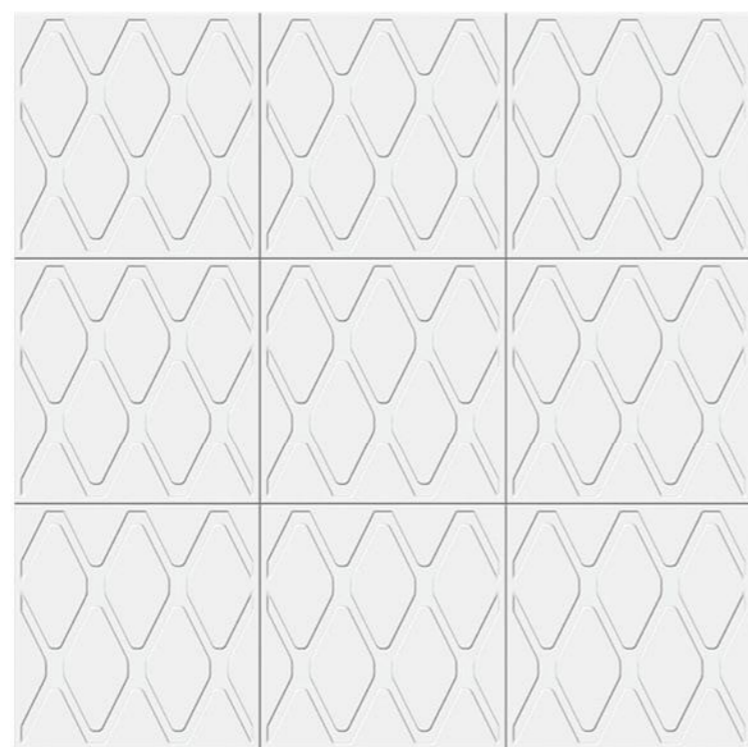

YCYX-011



YCHD-027 (LED)

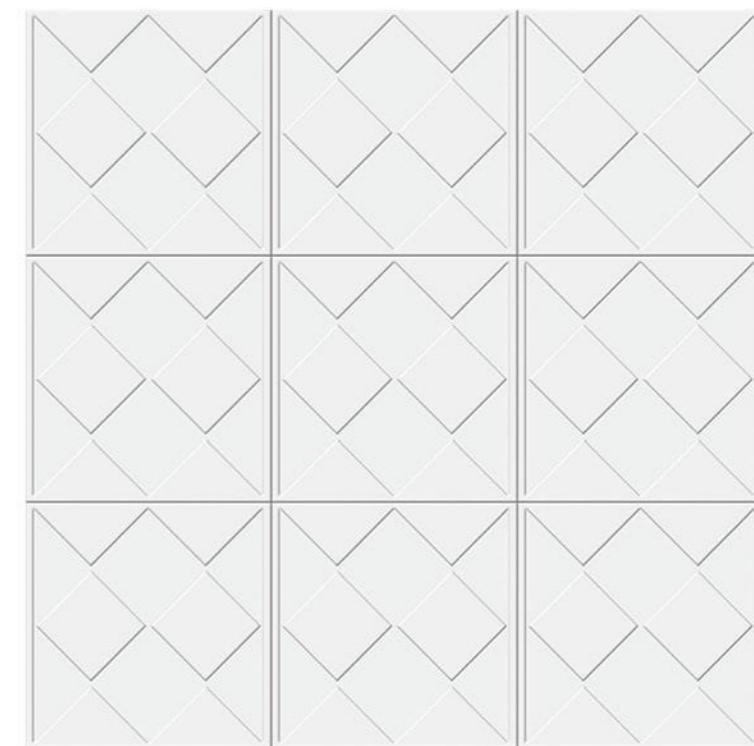

YCYX-012



YCHD-027 (LED)

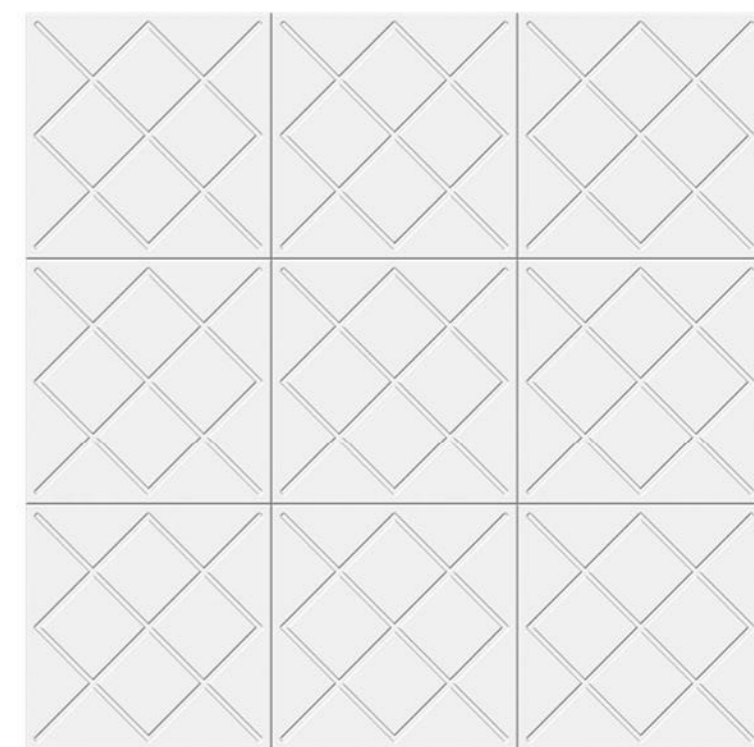



YCYX-013



YCHD-028 (LED)

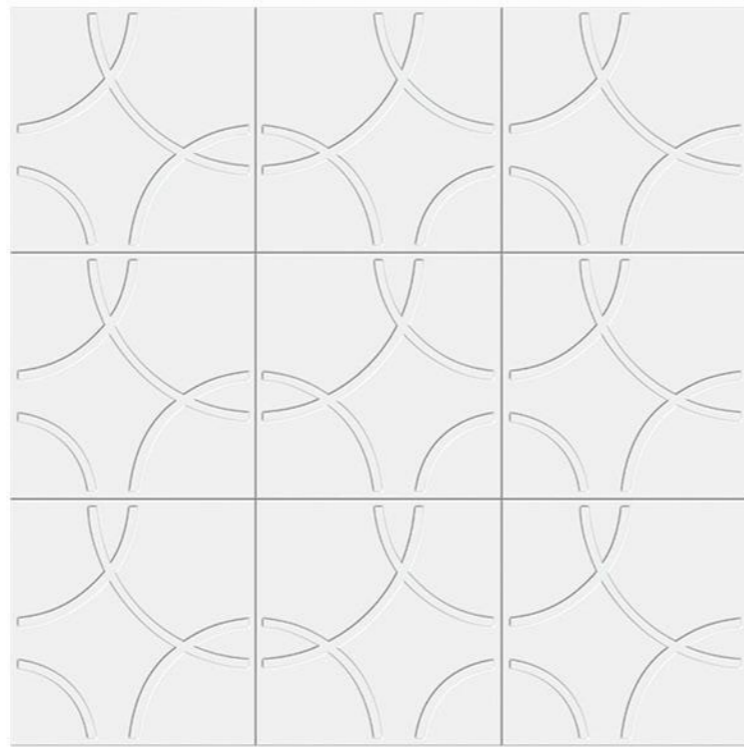

YCYX-014



YCHD-029 (LED)

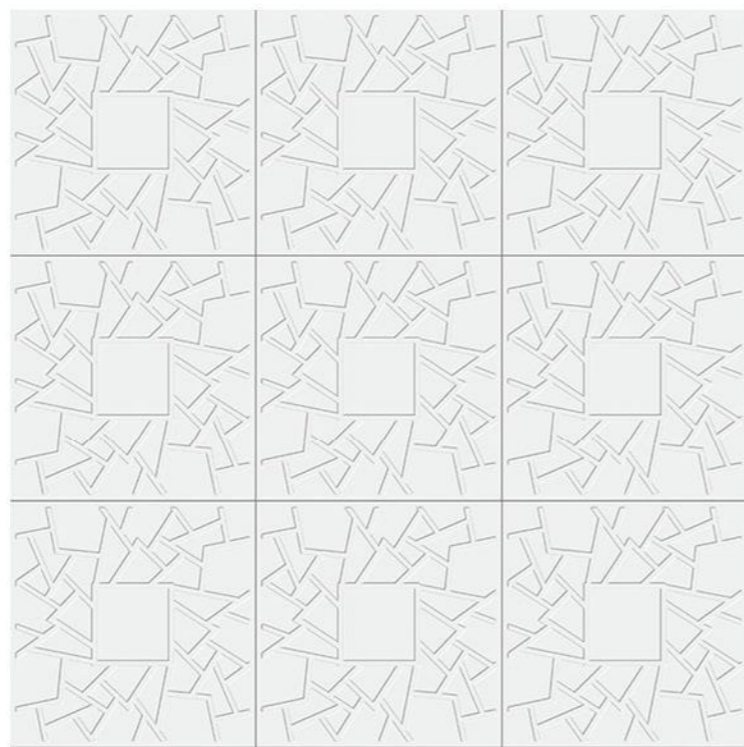

YCYX-015



YCHD-030 (LED)

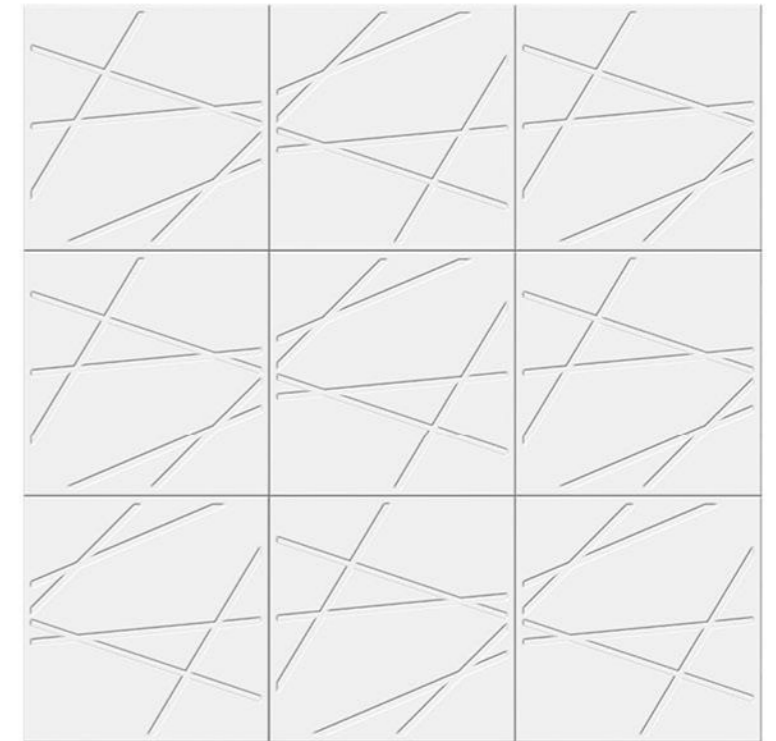

YCYX-016



YCHD-031 (LED)

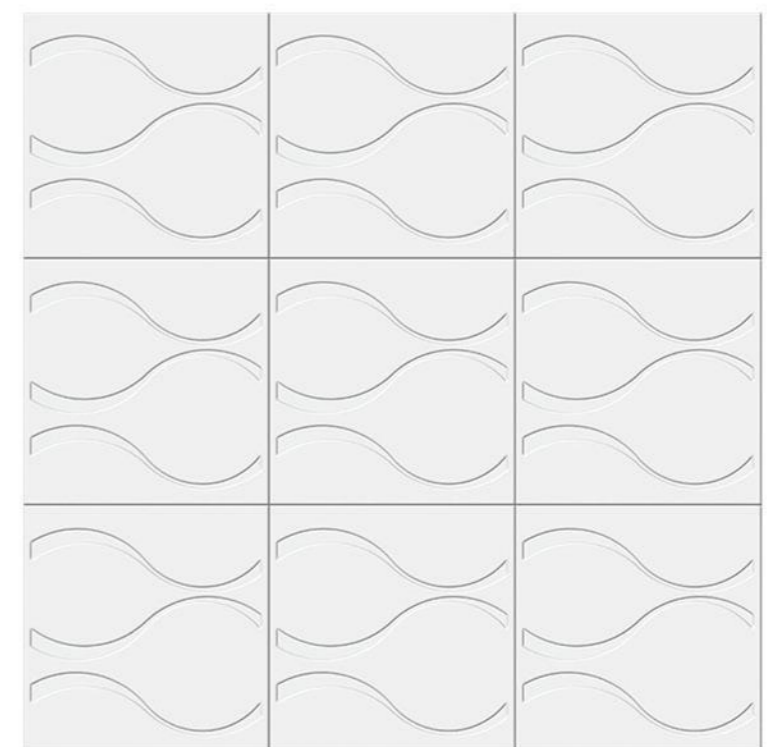



YCYX-017



YCYX-018



YCYX-019



YCHD-032 (LED)



YCHD-033 (LED)



YCHD-034 (LED)

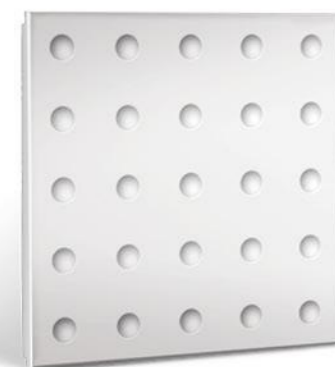

YCYX-020



YCYX-021



YCYX-022



YCHD-004 (LED)



YCHD-035 (LED)



YCHD-036 (LED)



YCYX-023



YCYX-024



YCYX-025



YCHD-037 (LED)



YCHD-037 (LED)



YCHD-038 (LED)



YCYX-026



YCYX-027



YCYX-028



YCHD-039 (LED)



YCHD-040 (LED)



YCHD-041 (LED)



YCYX-029



YCYX-030



YCYX-031



YCHD-033 (LED)



YCHD-042 (LED)



YCHD-043 (LED)



YCYX-032



YCYX-033



YCYX-034



YCYX-047



YCHD-044 (LED)



YCHD-045 (LED)



YCHD-046 (LED)



YCHD-061 (LED)



YCYX-035



YCYX-036



YCYX-037



YCYX-038



YCHD-047 (LED)

The above products are matched with LED lights

The 3D punching series



YCCY-01



YCCY-02



YCCY-03



YCCY-04



YCCY-05

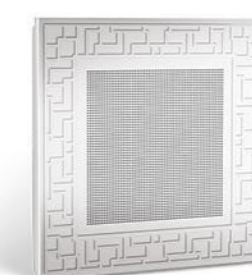

YCCY-06



YCCY-07



* Customized ceiling with LED light

Customized business brand/ logo/ individual customization available



THE LED LIGHT

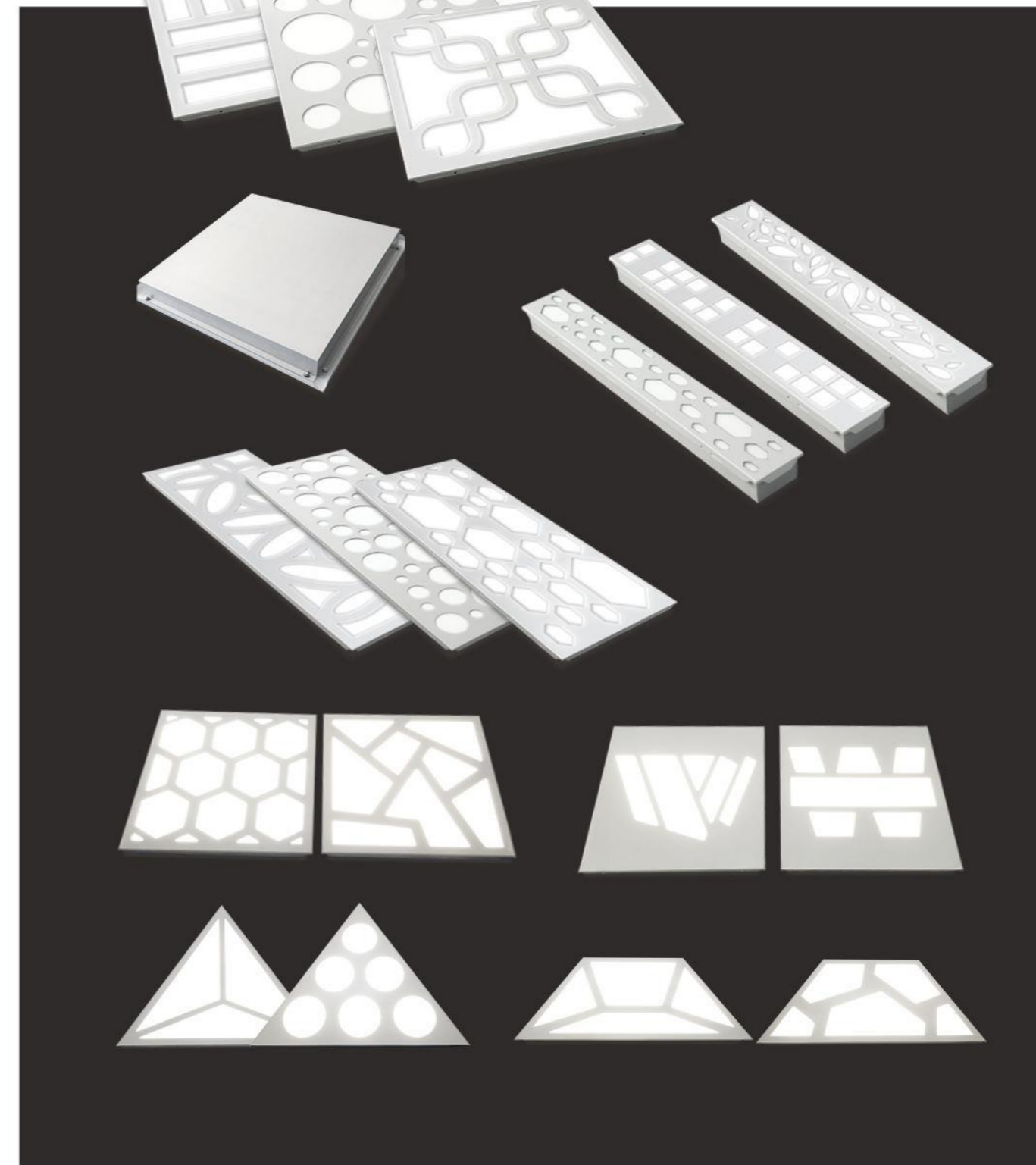

II

THE INNOVATION CEILING SERIES

Using the Triangular ceiling, Trapezoid ceiling and the Hexagonal ceiling unconventionally, creating a defined fashion space.



* The triangular ceiling Installation types:
 ① 30mm-lay-in carrier ② 15mm-lay-in carrier ③ triangular clip-in carrier

Instruction for lay-in ceiling

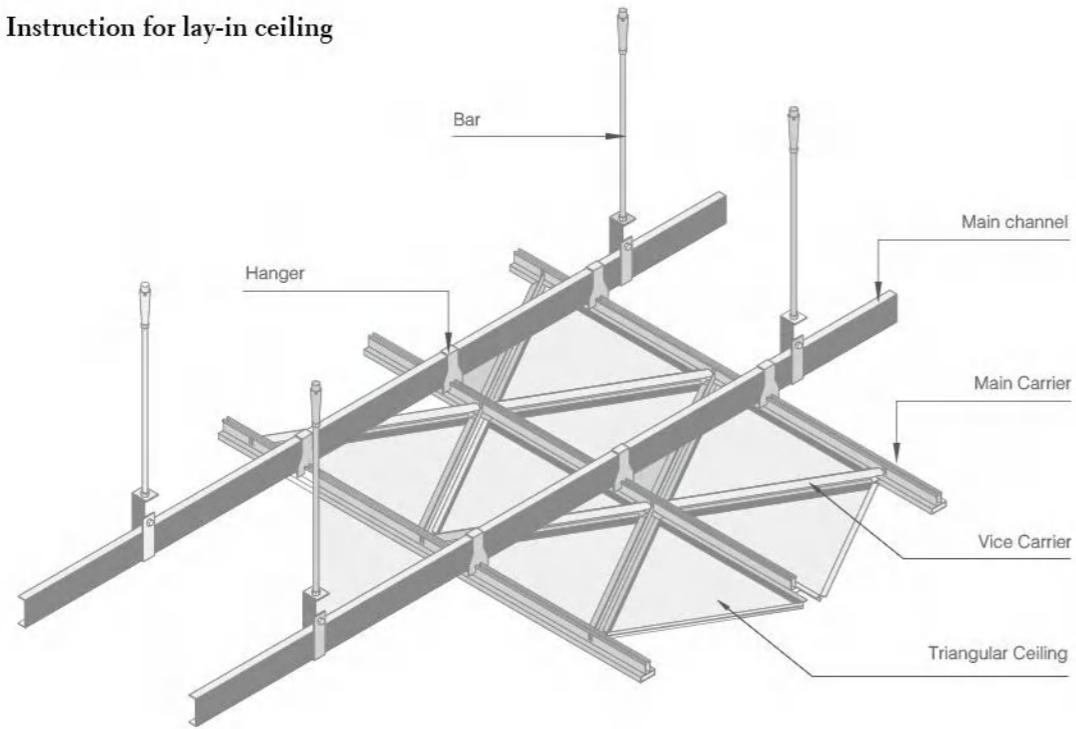

① 30mm-lay-in carrier

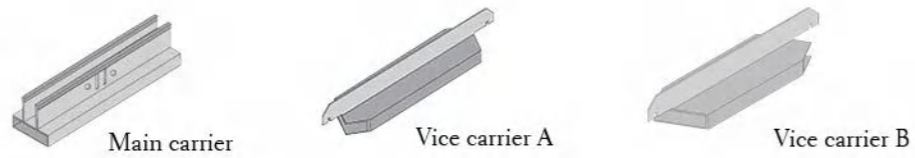

② 15mm-lay-in carrier

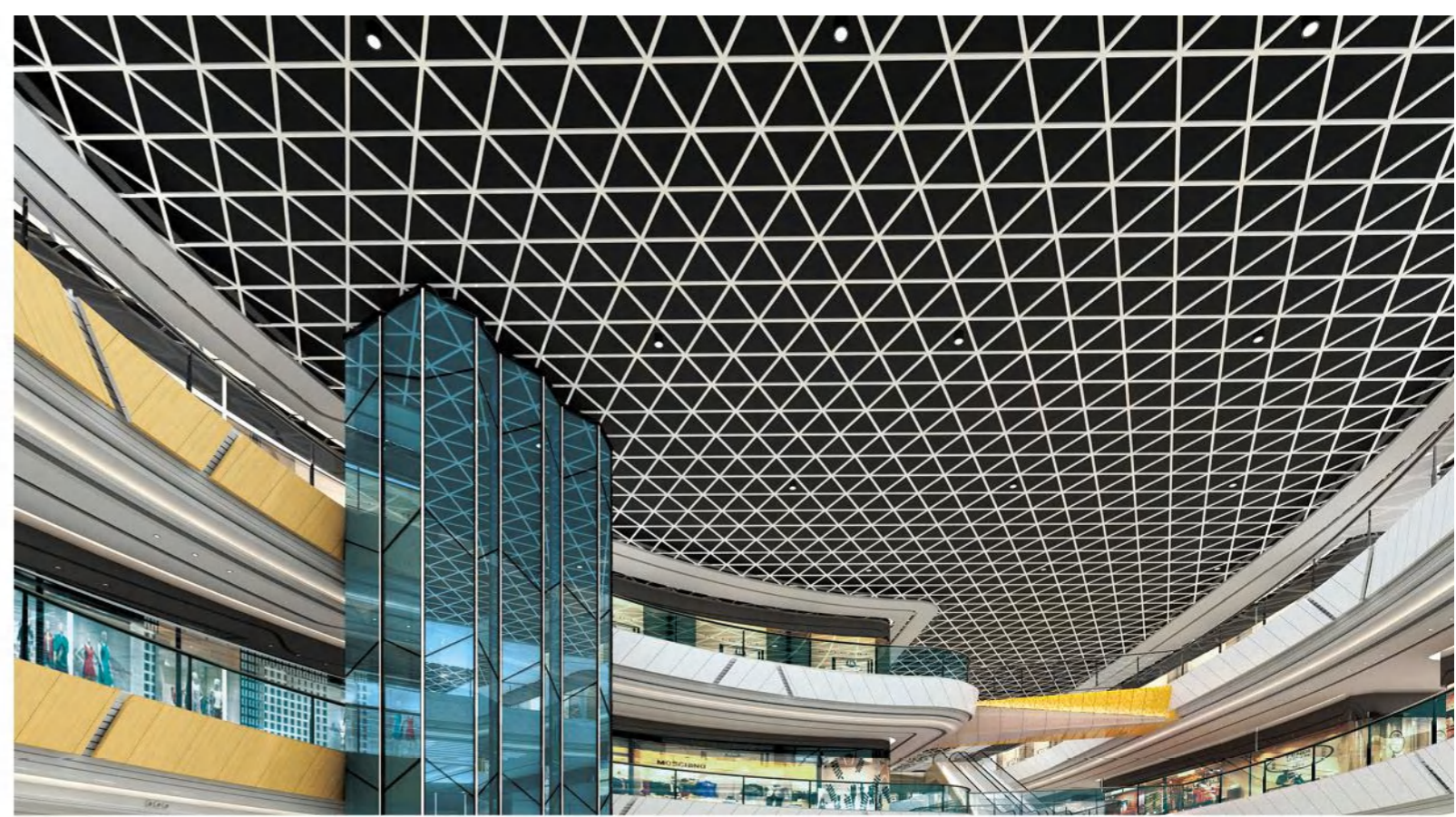
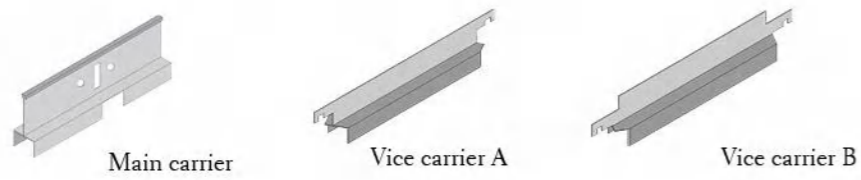

30mm carrier lay-in ceiling effect picture

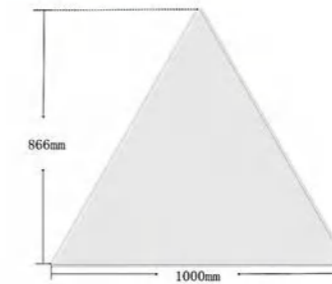



③ Instruction for triangular clip-in ceiling

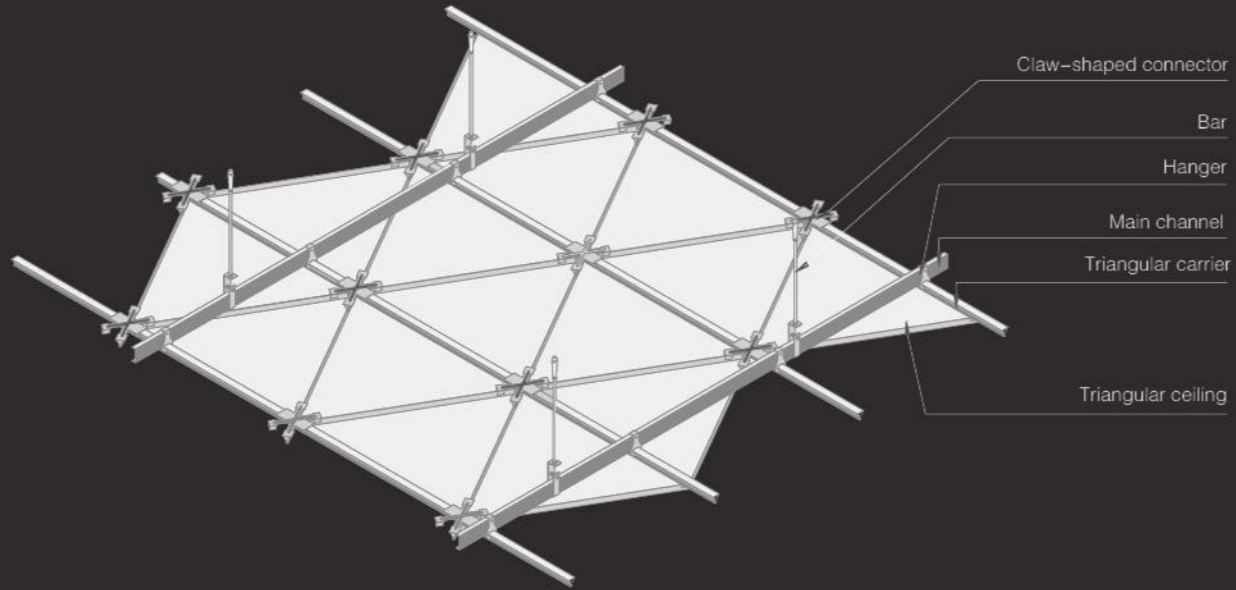

Combination use of the Triangular plain ceiling and the Triangular perforated ceiling.

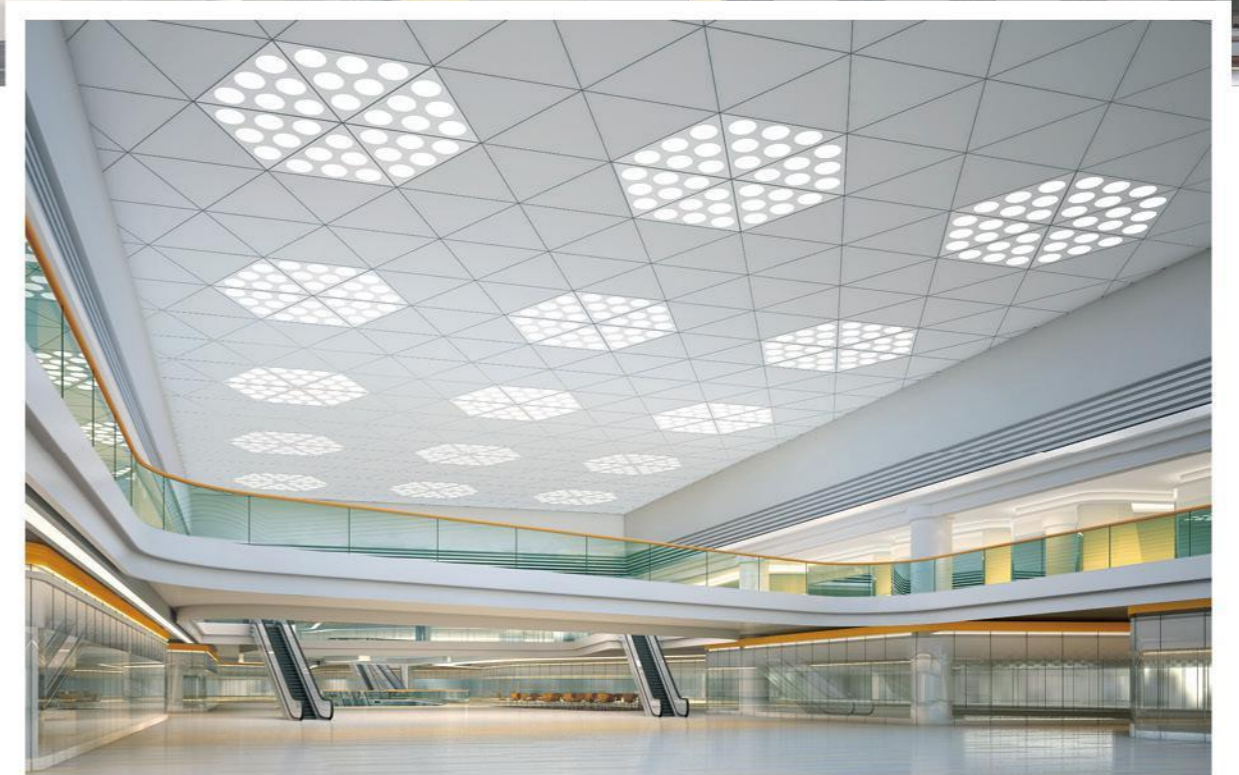
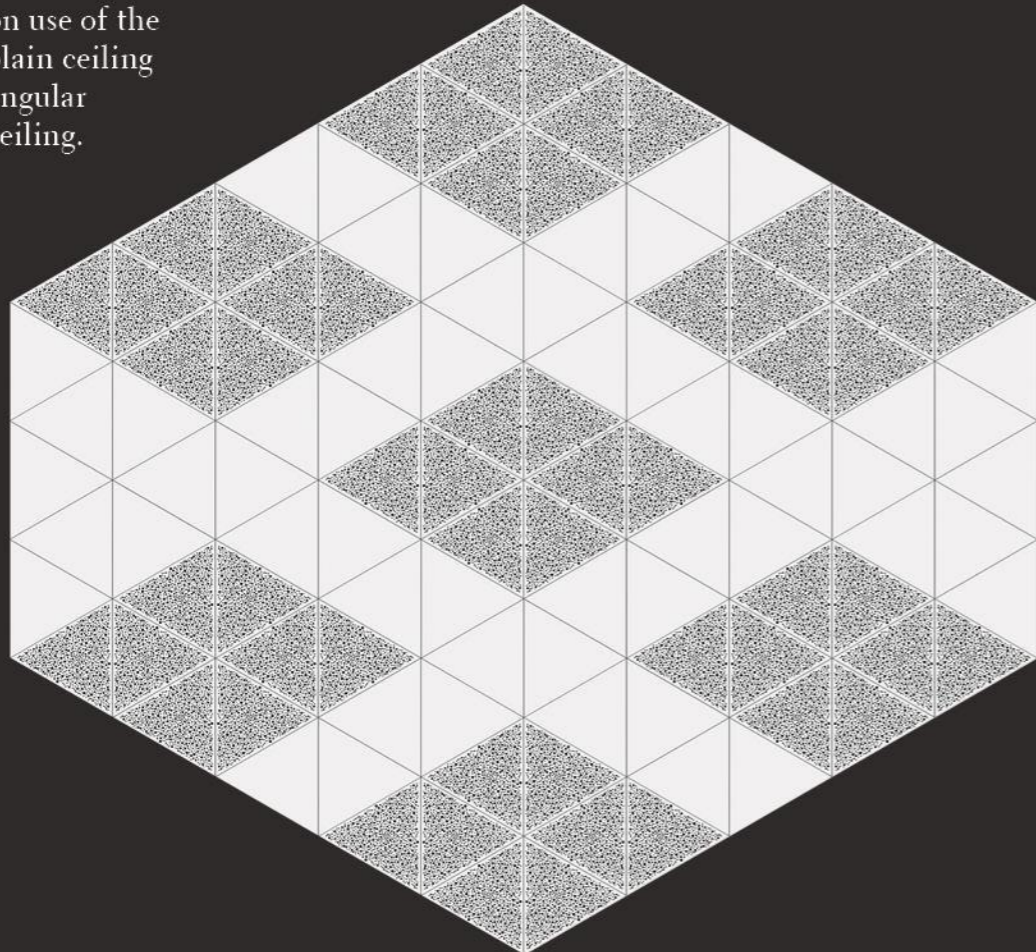

Combination effect of plain ceiling and LED light

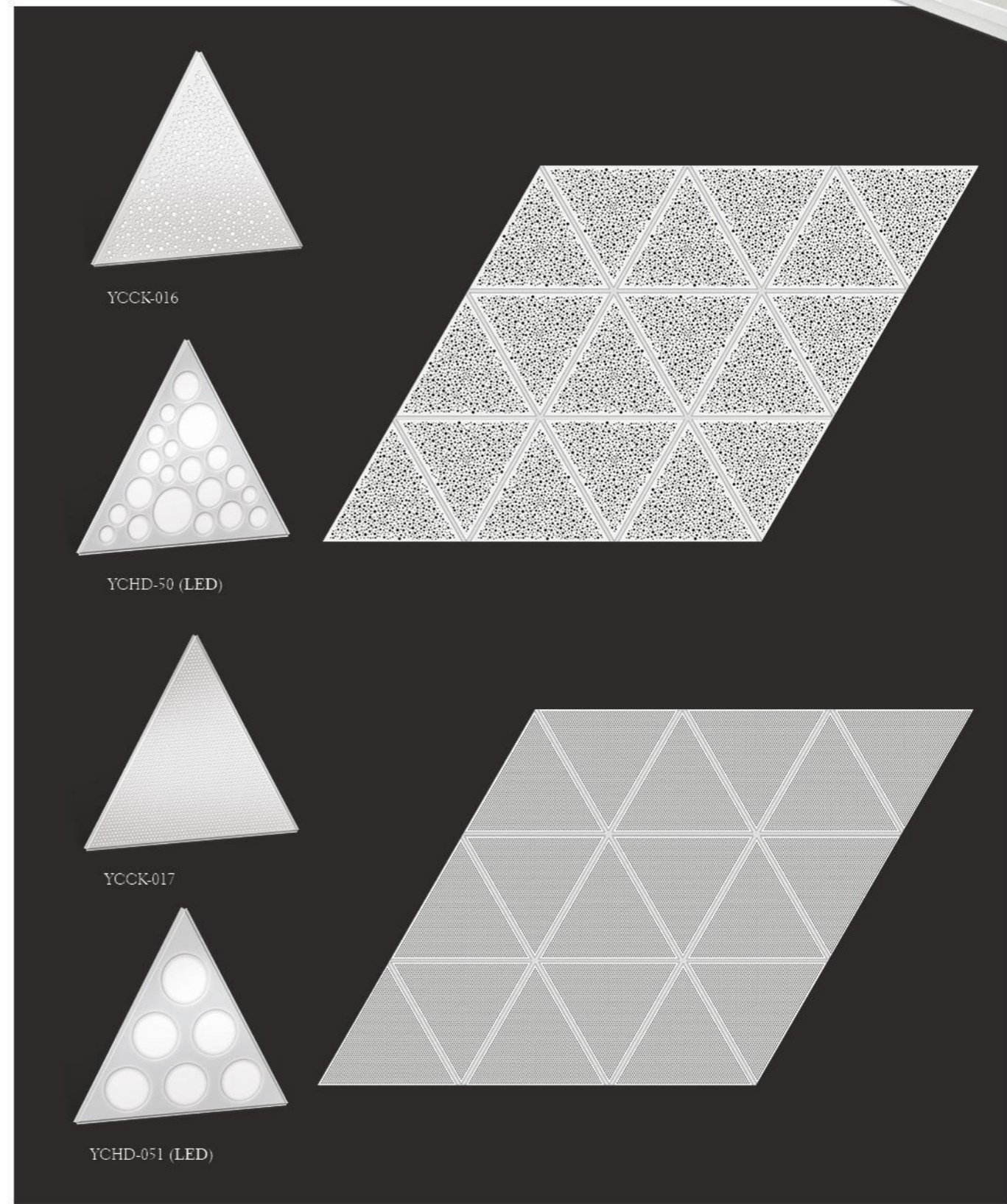
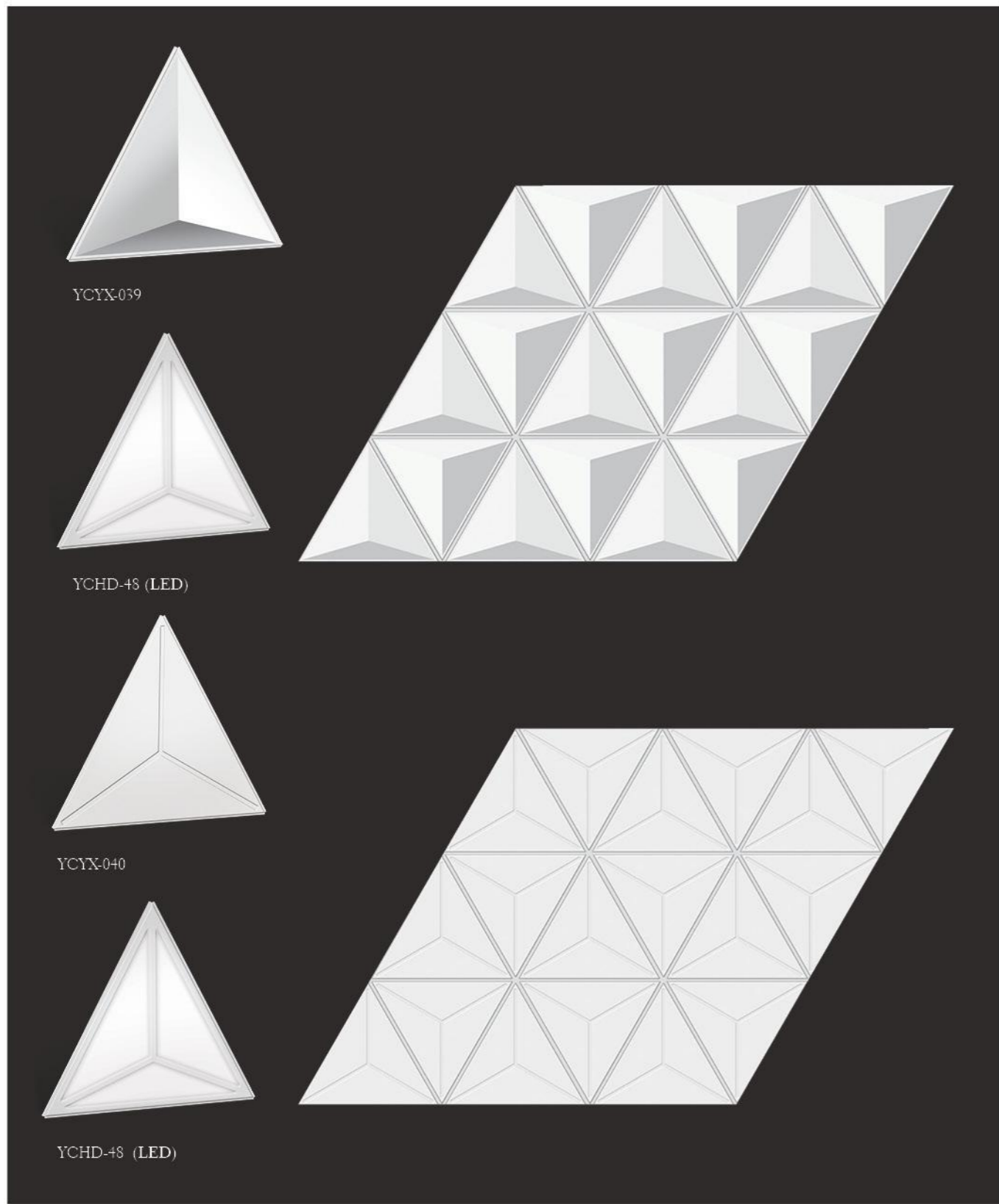

✦ The trapezoid ceiling

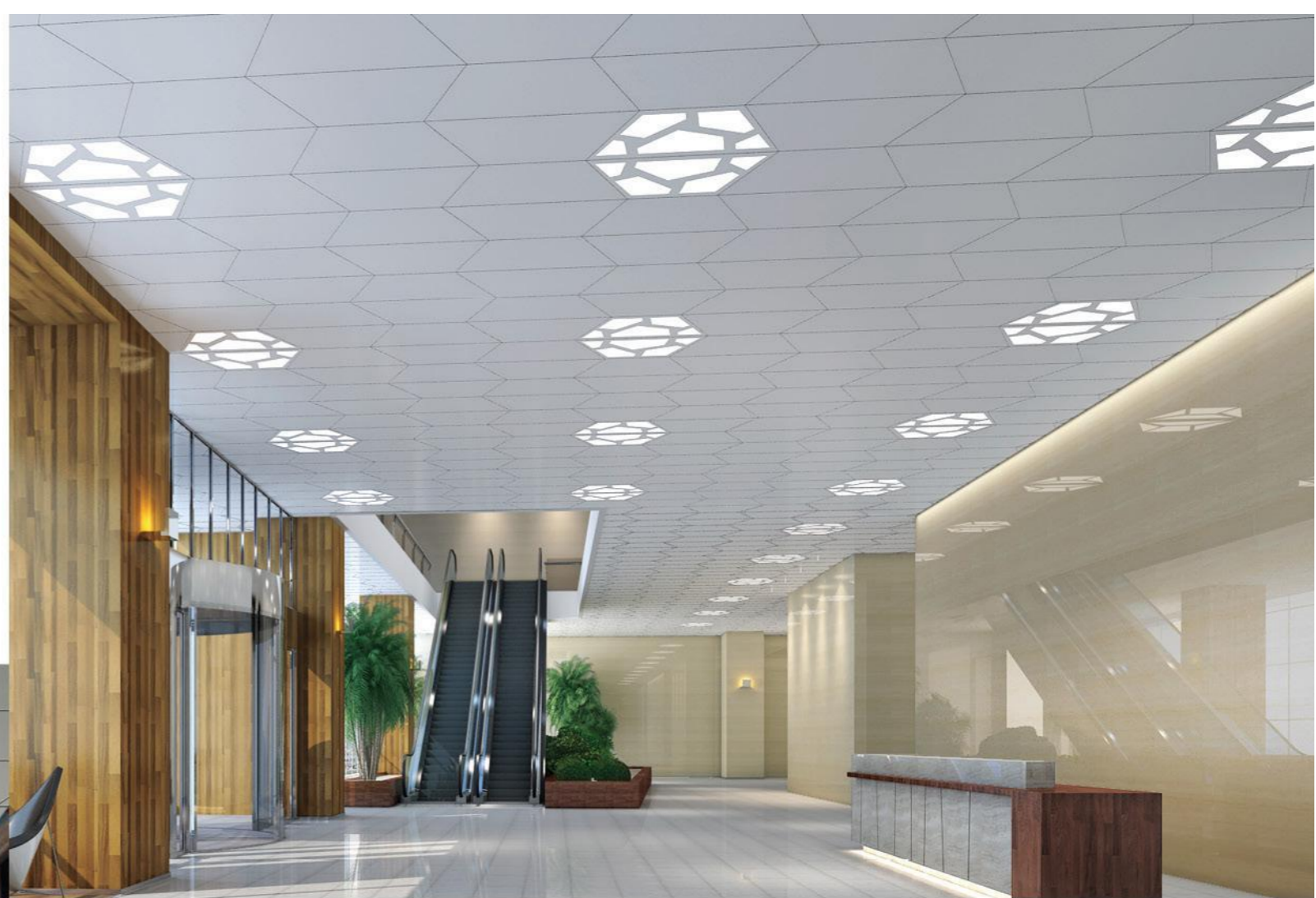
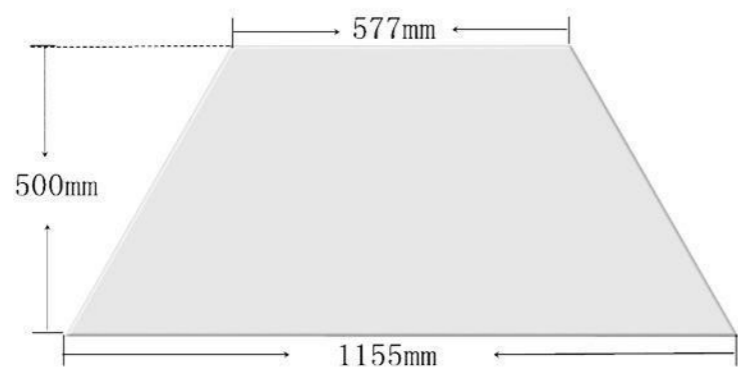

Instruction
(Triangular Clip-in Carrier)

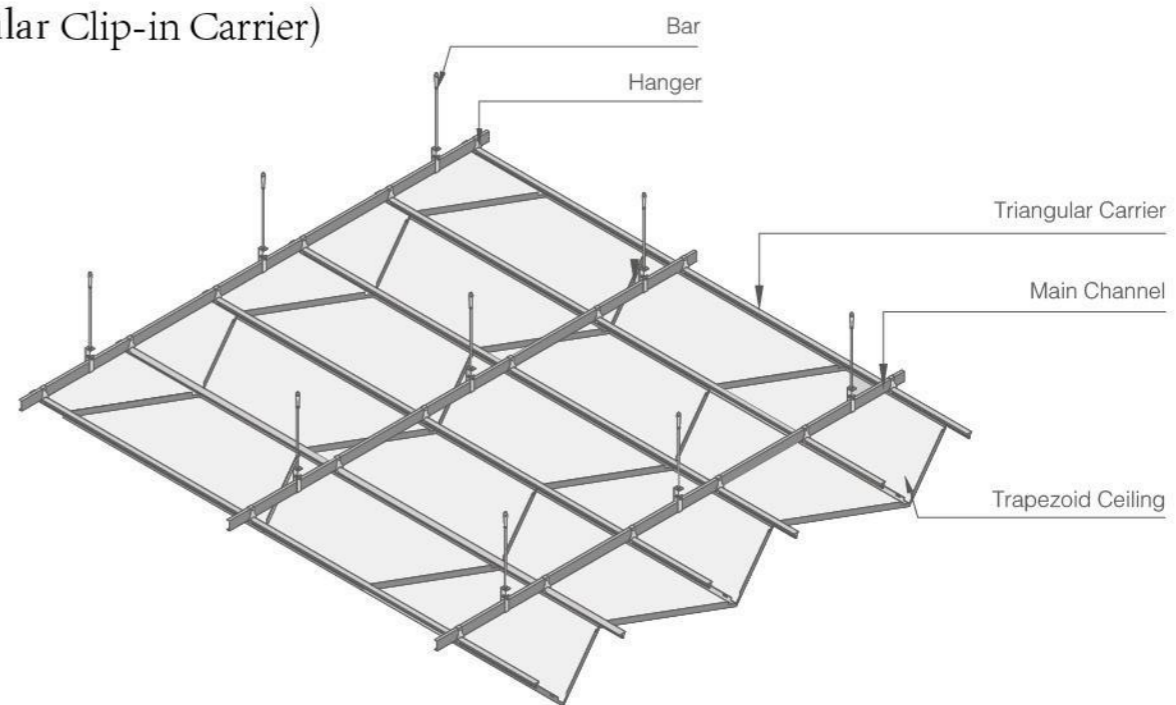

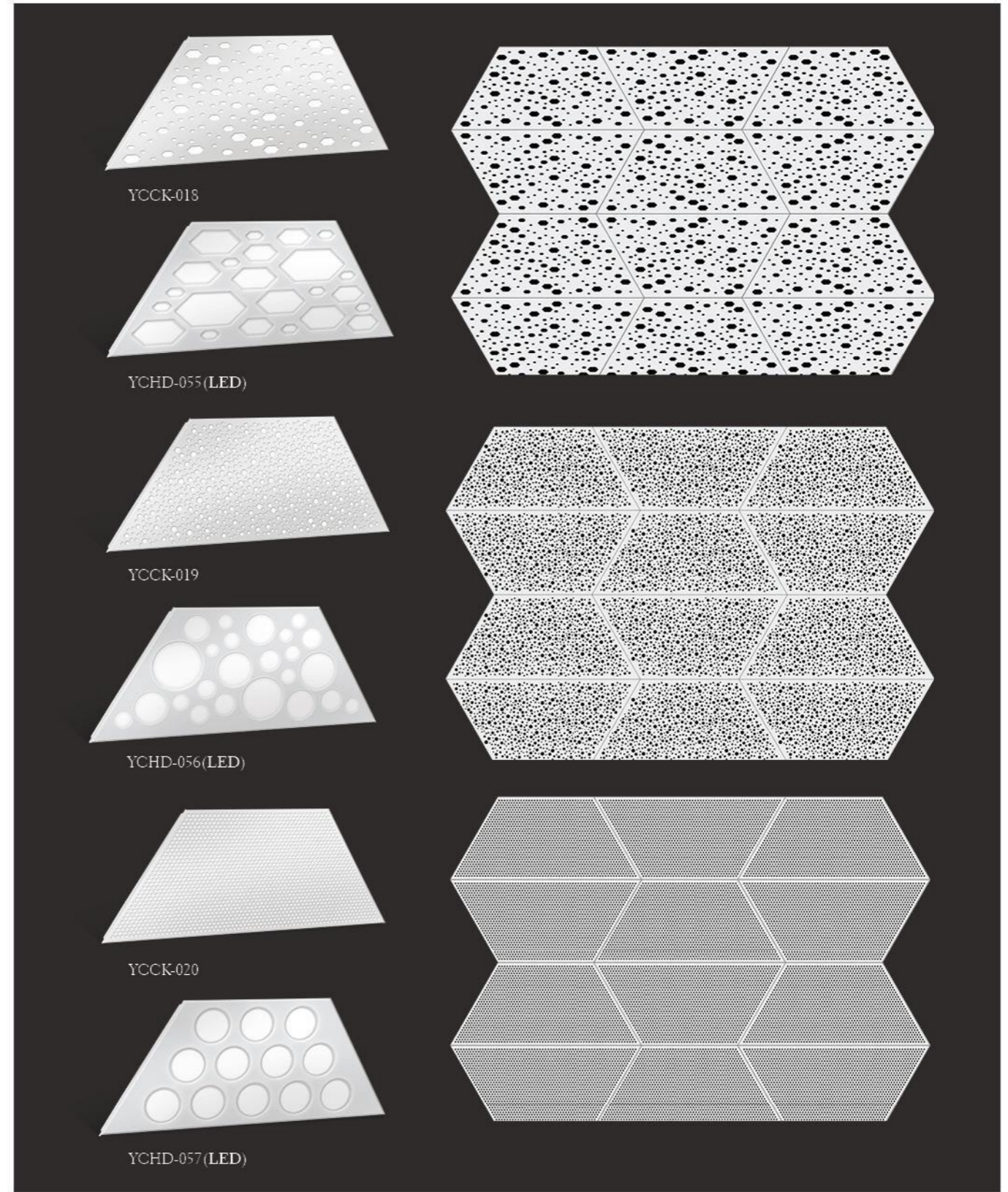
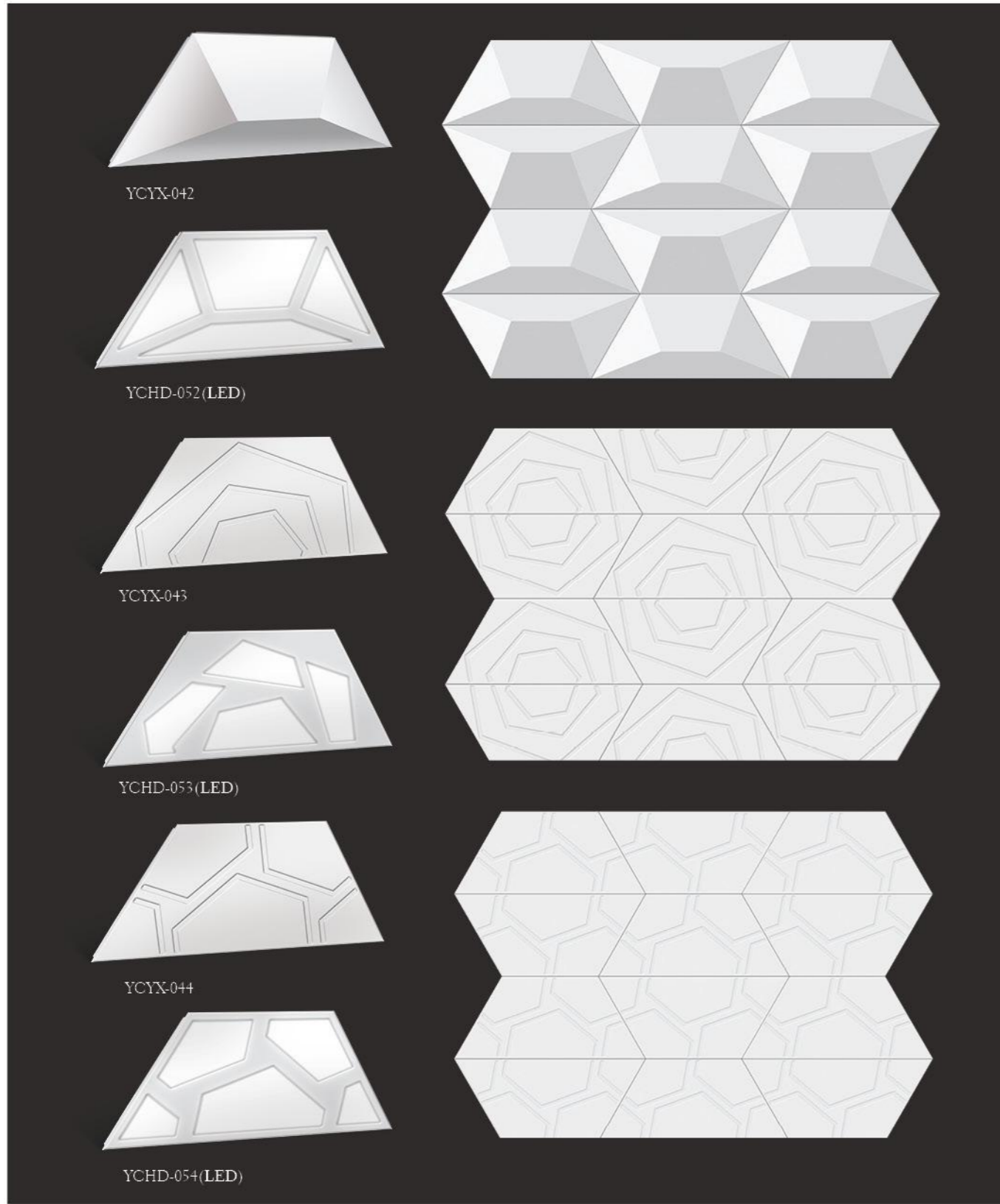



* The hexagonal ceiling

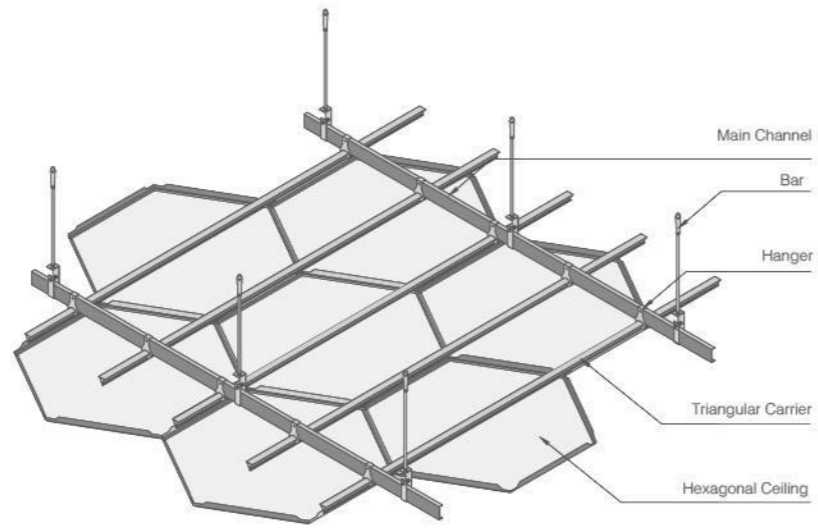
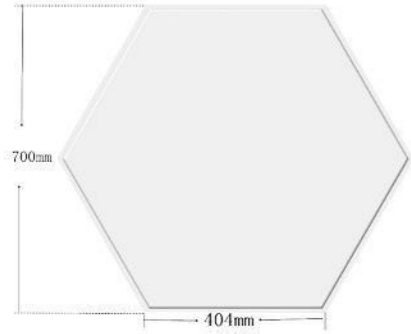

YCYX-045



YCHD-058(LED)

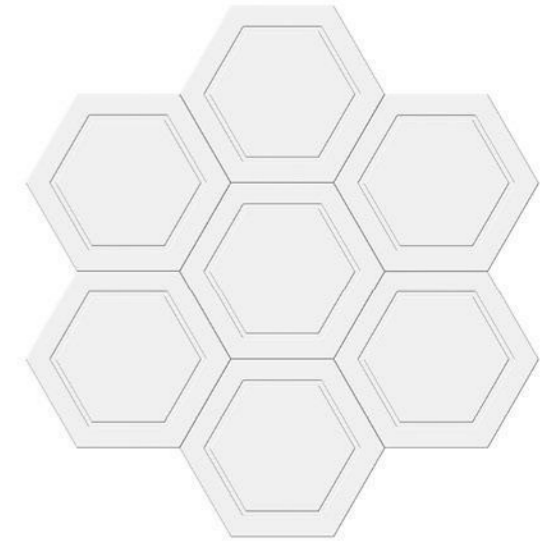

YCYX-046



YCHD-059(LED)

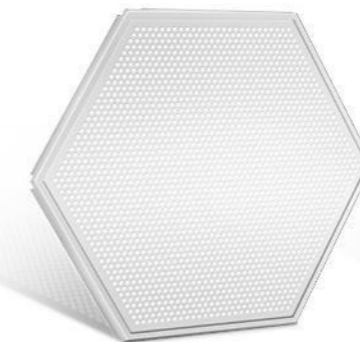
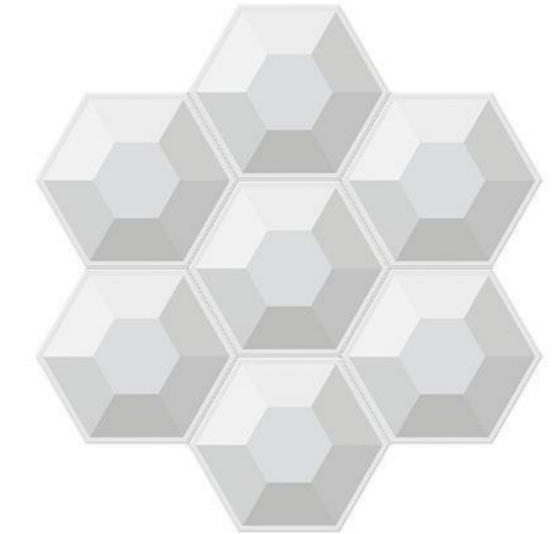

YCCK-021



YCHD-060(LED)

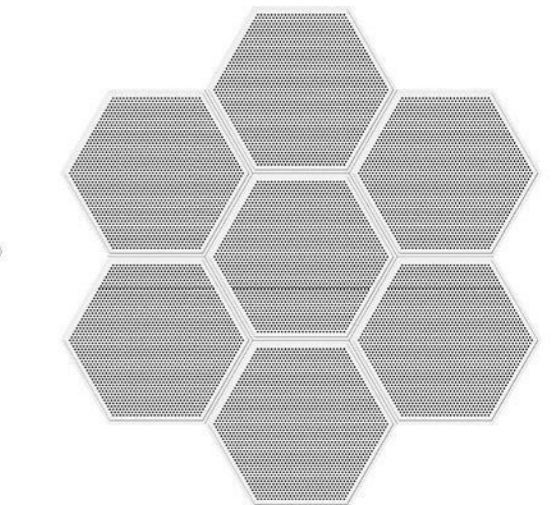

* Hexagonal-shaped groove ceiling

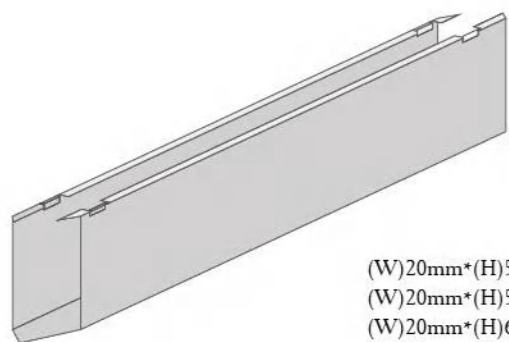

- (W)20mm*(H)50mm*(L)200mm
- (W)20mm*(H)50mm*(L)250mm
- (W)20mm*(H)60mm*(L)200mm
- (W)20mm*(H)60mm*(L)250mm
- (W)30mm*(H)60mm*(L)300mm
- (W)30mm*(H)60mm*(L)350mm
- (W)30mm*(H)70mm*(L)300mm
- (W)30mm*(H)70mm*(L)350mm
- (W)30mm*(H)80mm*(L)300mm
- (W)30mm*(H)80mm*(L)350mm

Instruction

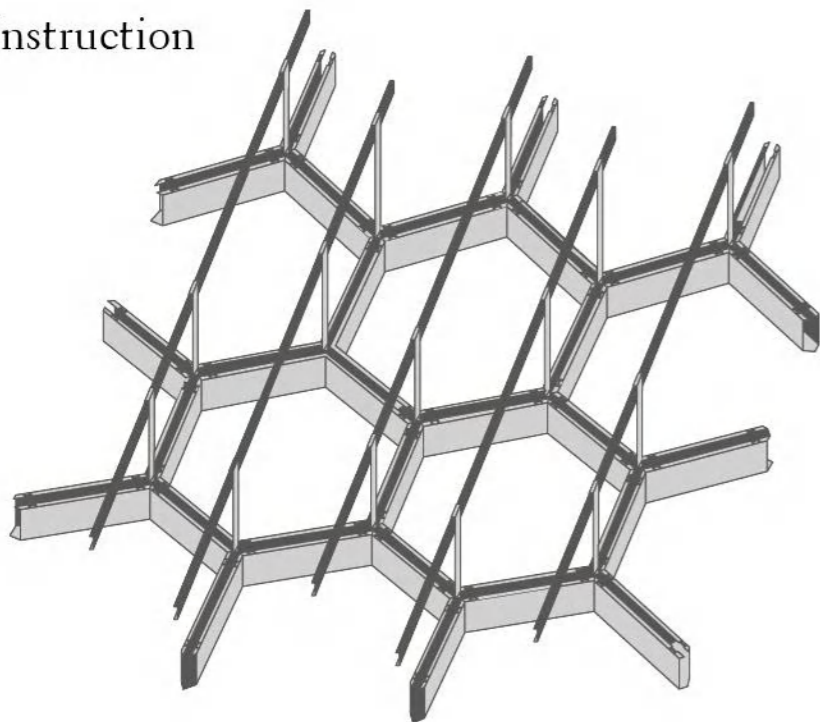



THE CREATIVE SPACE

Standard size products used with normal ceilings, same installation .To select the below standard parts, creating a flexible and exquisite space.Beside the tradition white color, golden, silver and wood grain are also available

✦ YCCY-001 Interval groove

Available width: 100mm, 150mm

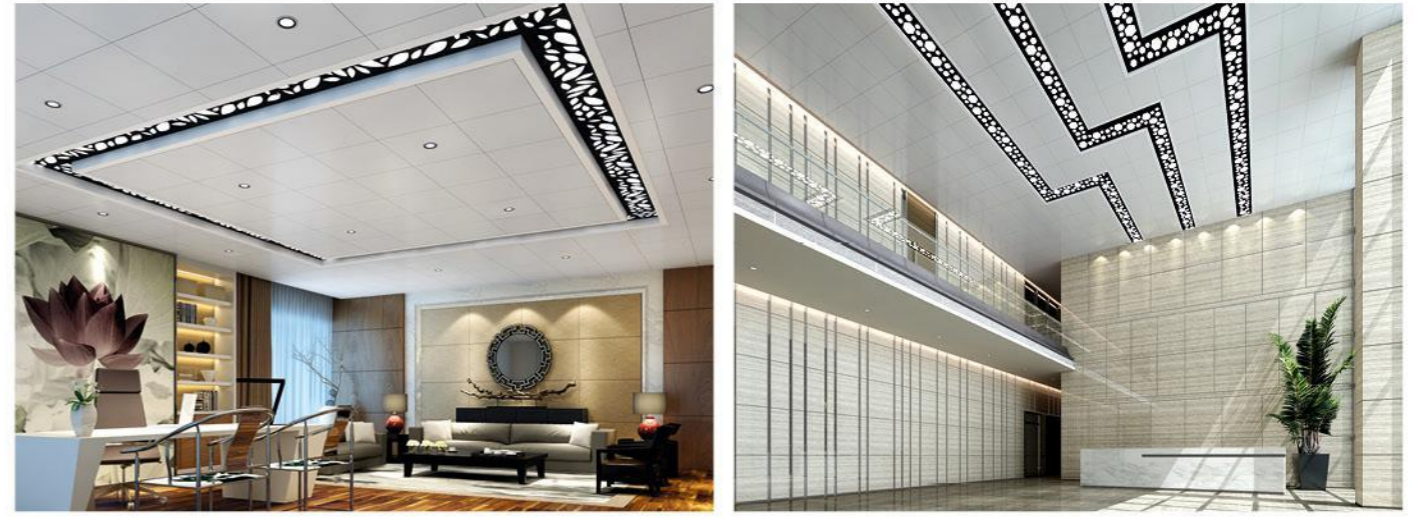
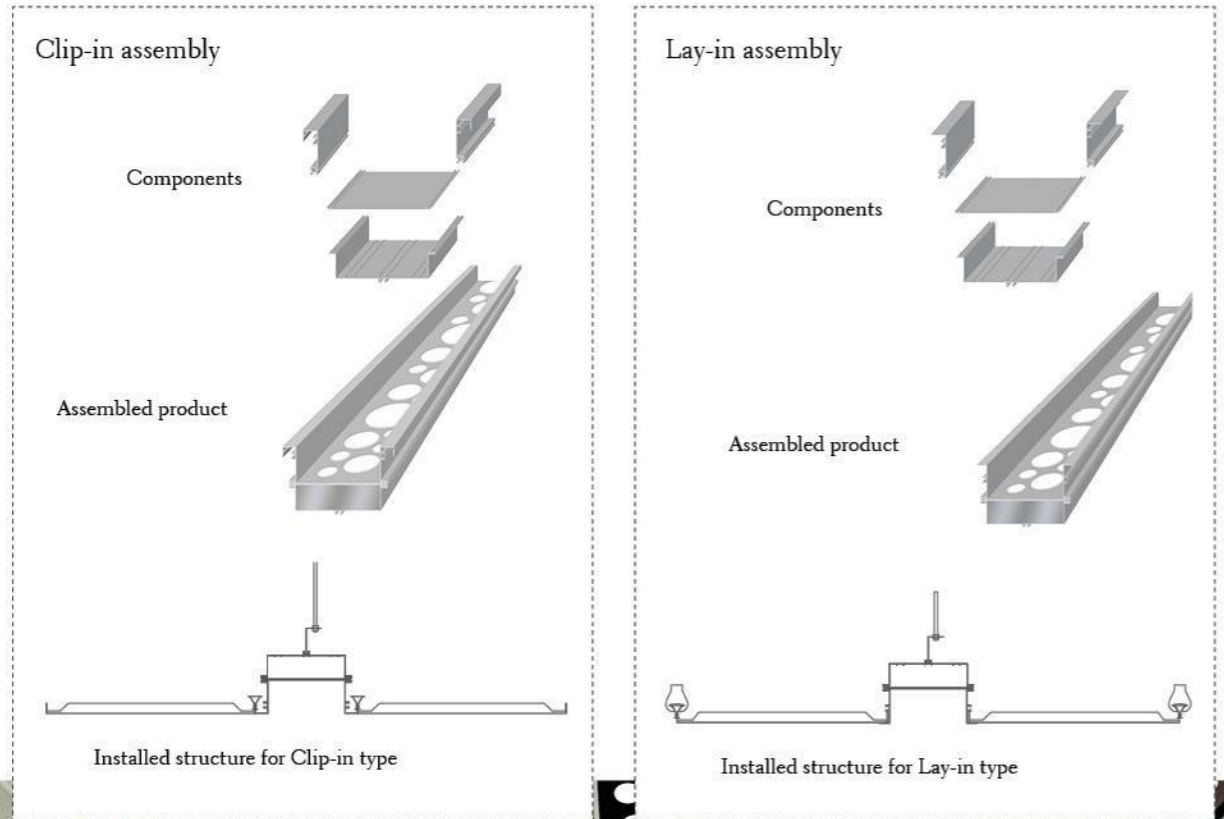

Instruction

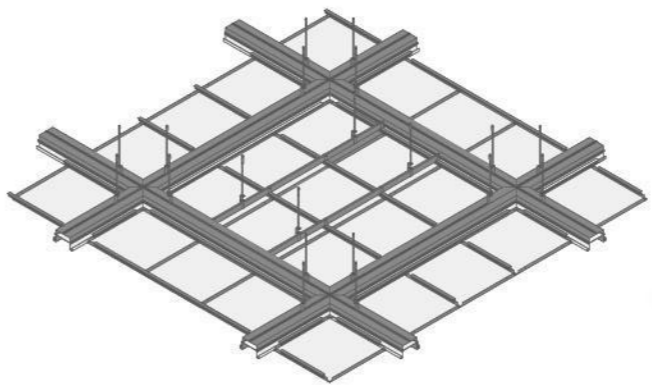

Available LED lights as below

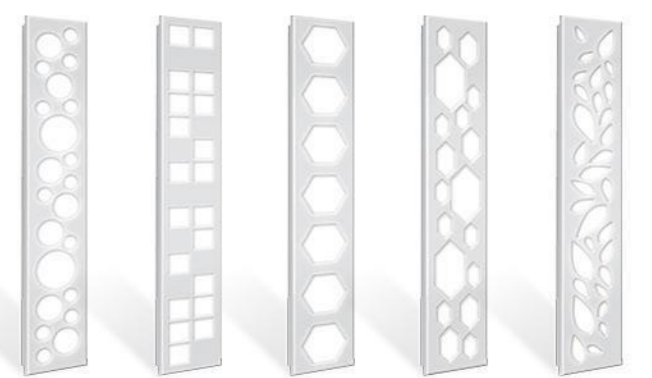

LED-1 LED-2 LED-3 LED-4 LED-5

✦ YCCY-002 Arc lower frame of the bilaminar suspended ceiling

Available specifications:
800*800mm、700*700mm、600*600mm、450*450mm、
500*800mm、500*700mm、500*600mm

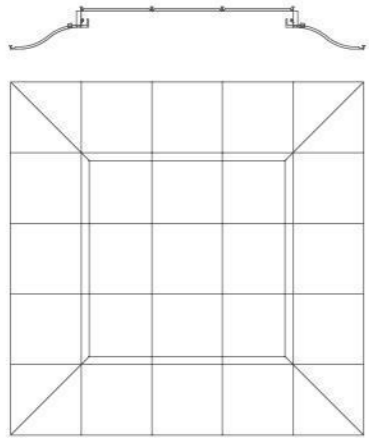

Arc corner



✦ YCCY-003 Symmetric arc panel

Available specifications:
800*800mm、700*700mm、600*600mm、500*800mm、
450*450mm、500*700mm、500*600mm

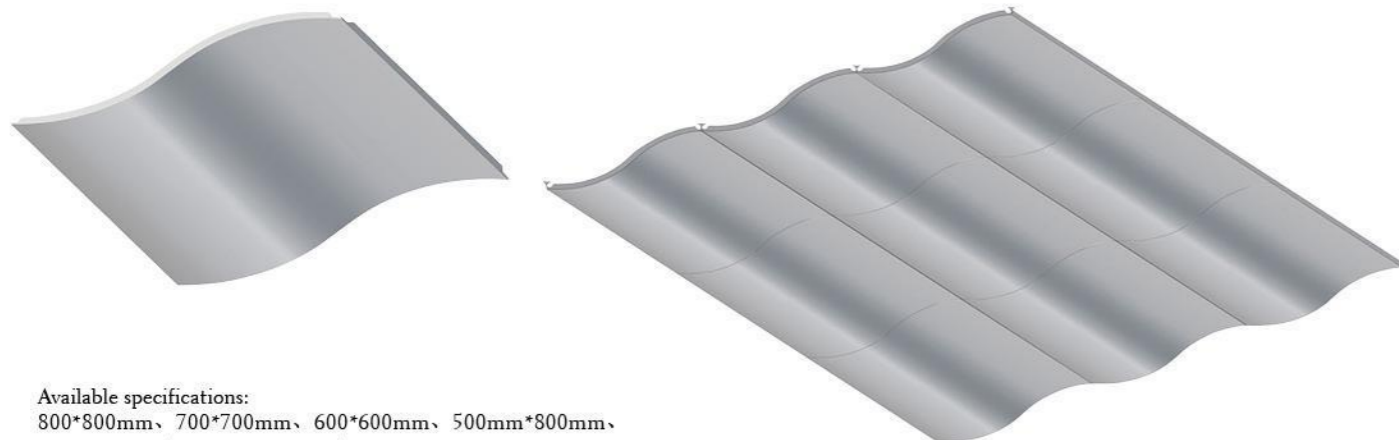

✦ YCCY-004 Asymmetric arc panel

Available specifications:
800*800mm、700*700mm、600*600mm、450*450mm、
500mm*800mm、500mm*700mm、500mm*600mm

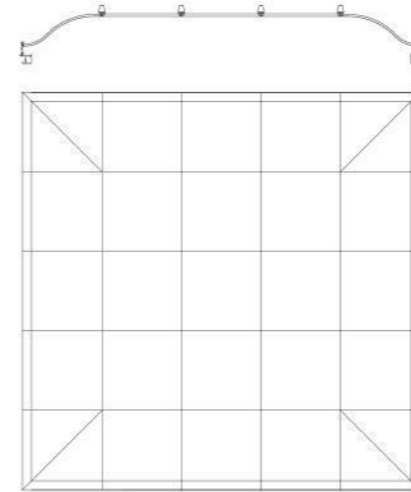

Arc corner

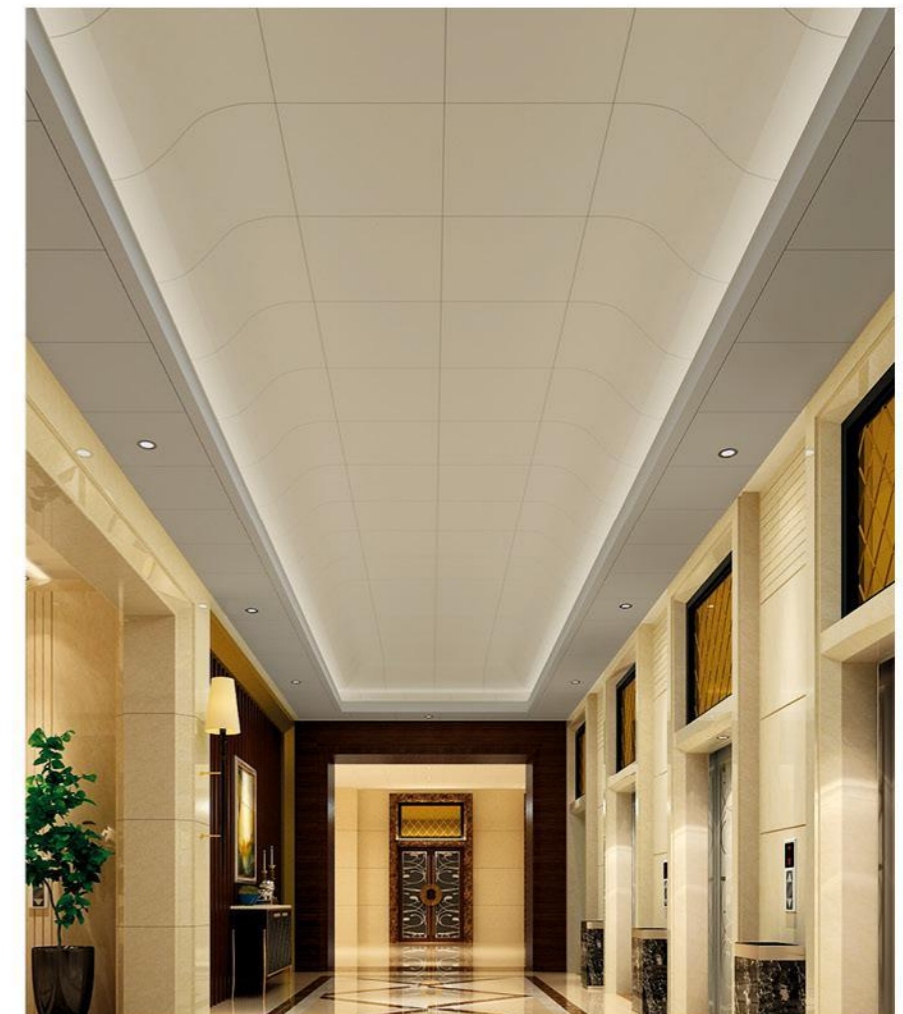
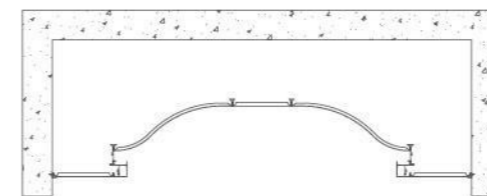

* YCCY-005 Symmetric deep-arc panel

Available specifications:
800*800mm、700*700mm、600*600mm

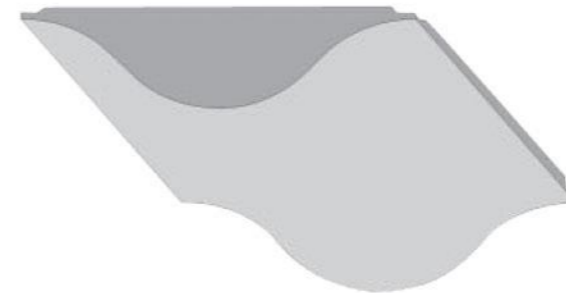

The symmetric deep-arc panel uses triangular clip-in carrier to install

✦ YCCY-006 Projecting square panel

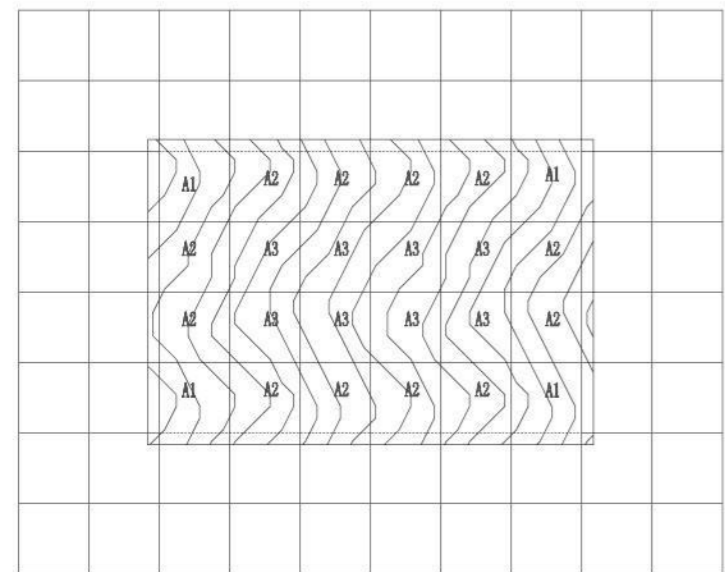

A1



A2

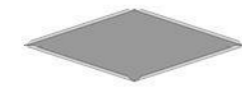

A3



Available specifications:
800*800mm、700*700mm、600*600mm

Wood color projecting square panel



Combination effect with plain panel

Available wood color as below



YKS0002

YKS0010

YH10347

YH10330

YKS0016

YH10346



YKS0015

YKS0025

YKS0028

YKS0029

YH10335

YKS0035

Effect picture





White color projecting square panel



✦ YCCY-007 LED strip

Available LED lights as below

Available specifications:
 100*800mm、100*700mm
 100*600mm、150*800mm
 150*700mm、150*600mm

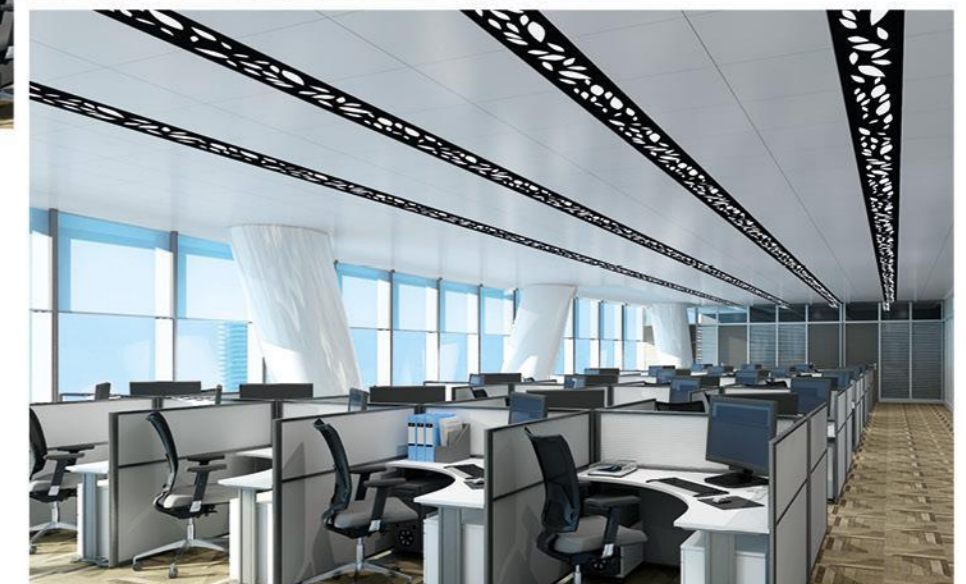
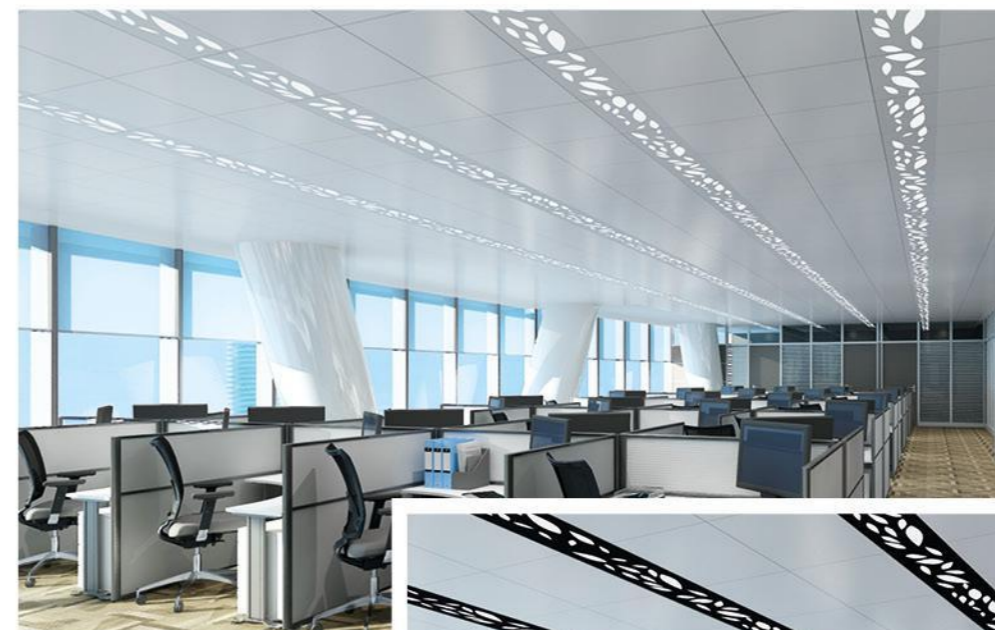
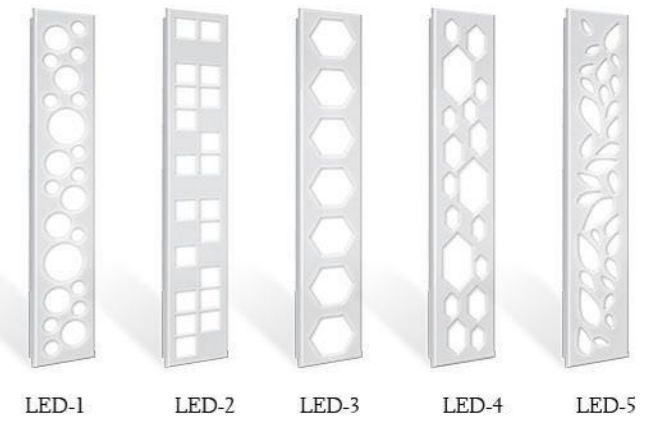

* YCCY-008 Troffer

Available specifications:
150*1500mm、150*2000mm
200*1500mm、200*2000mm

Instruction

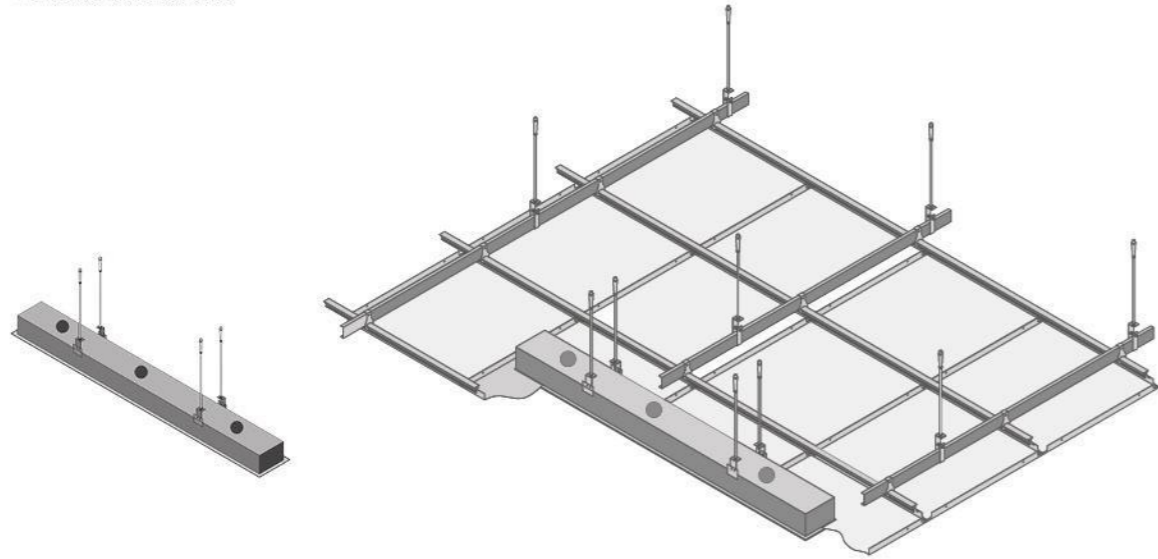

* YCCY-009
Bilaminar border



Clip-in assembly

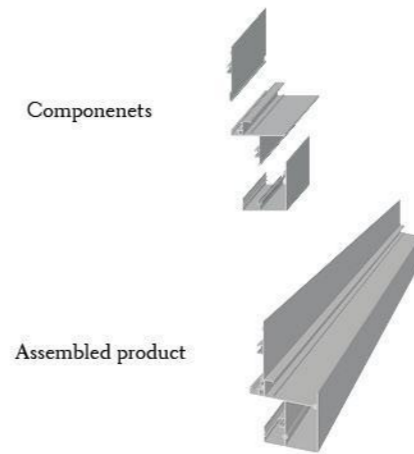

4 clip-in models as below

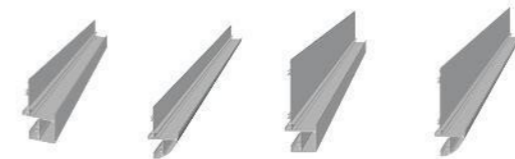

2 high edge models for ventilation system installation

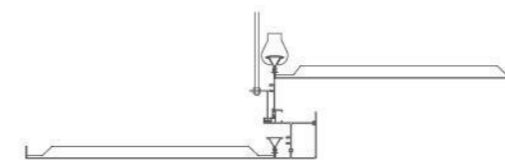

Installed structure for clip-in model

Lay-in assembly

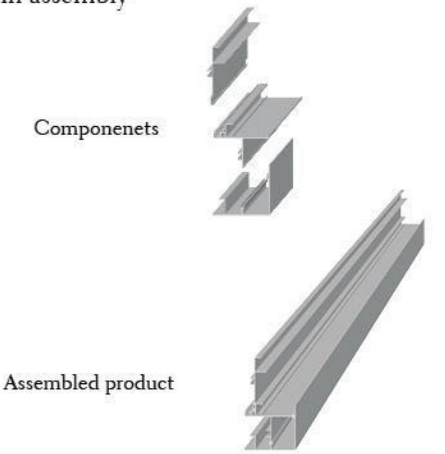

4 lay-in models as below

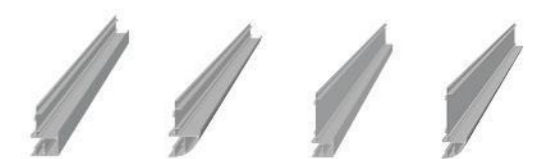

2 high edge models for ventilation system installation

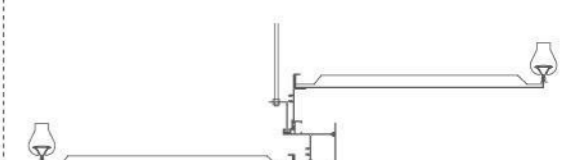

Installed structure for lay-in model

* YCCY-010 3D inverted triangle panel

Optional LED light 3D inverted triangle panel

Available specifications:
800*800mm, 700*700mm, 600*600mm

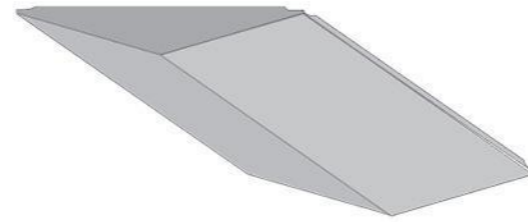

* YCCY-011
Suspended round panel

700mm diameter

Optional LED light suspended round panel

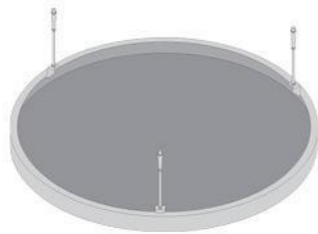

* YCCY-012 Suspended triangle panel

Optional LED light suspended triangle panel

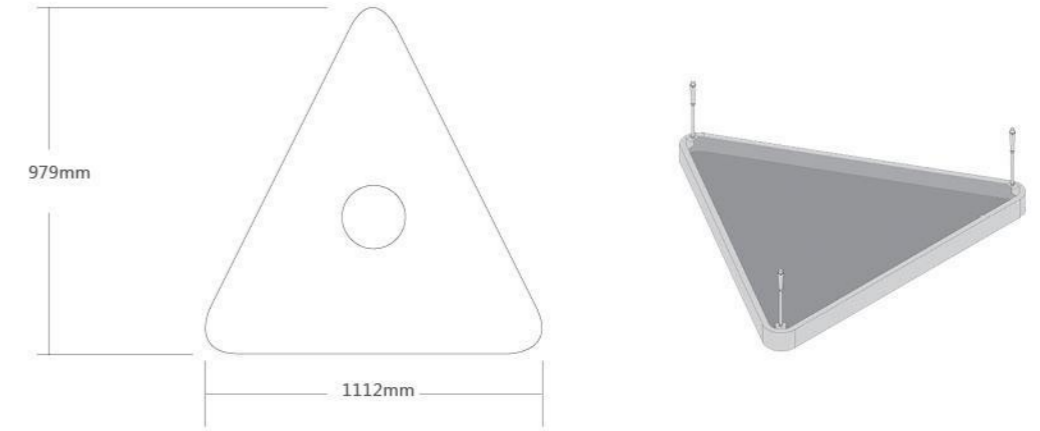

* YCCY-013 Arc groove

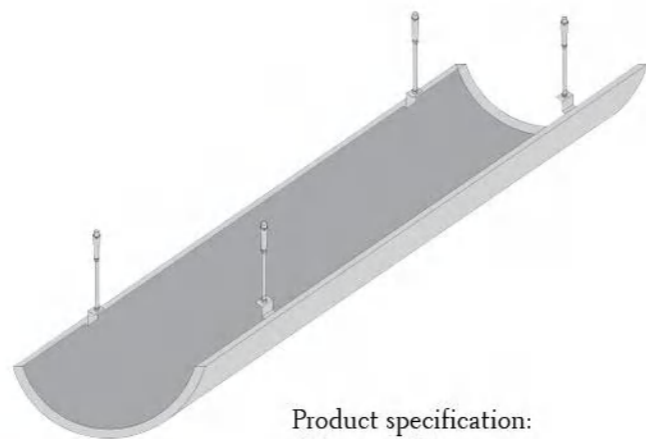

Product specification:
400mm*1400mm

Optional LED light arc groove



* YCCY-014 Horizontal wavy groove

Production specification:
40mm width*100mm height*2000mm length

* YCCY-015 Zigzag groove

Product specification:
100mm width*40mm height* 2000mm length

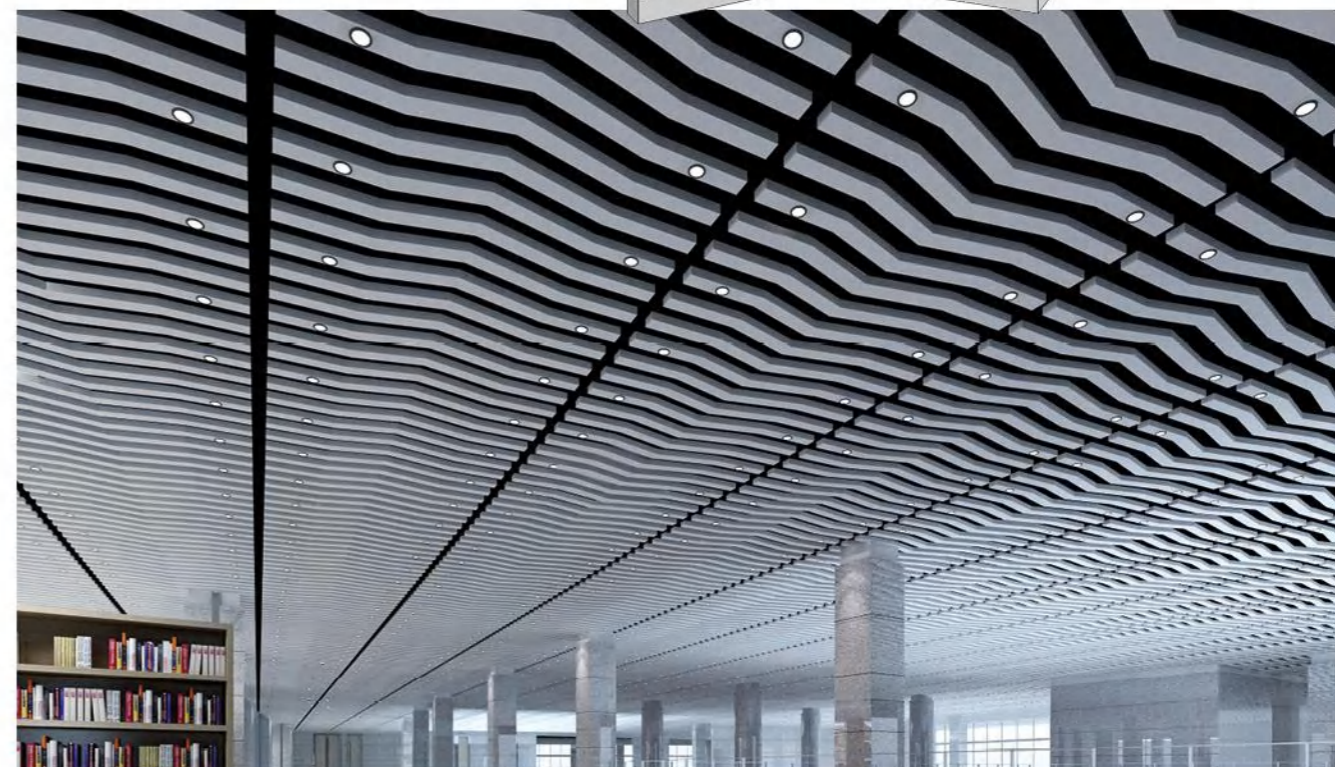

* YCCY-016 Vertical wavy groove



Product specification:
40mm width*50mm
height*2000mm length

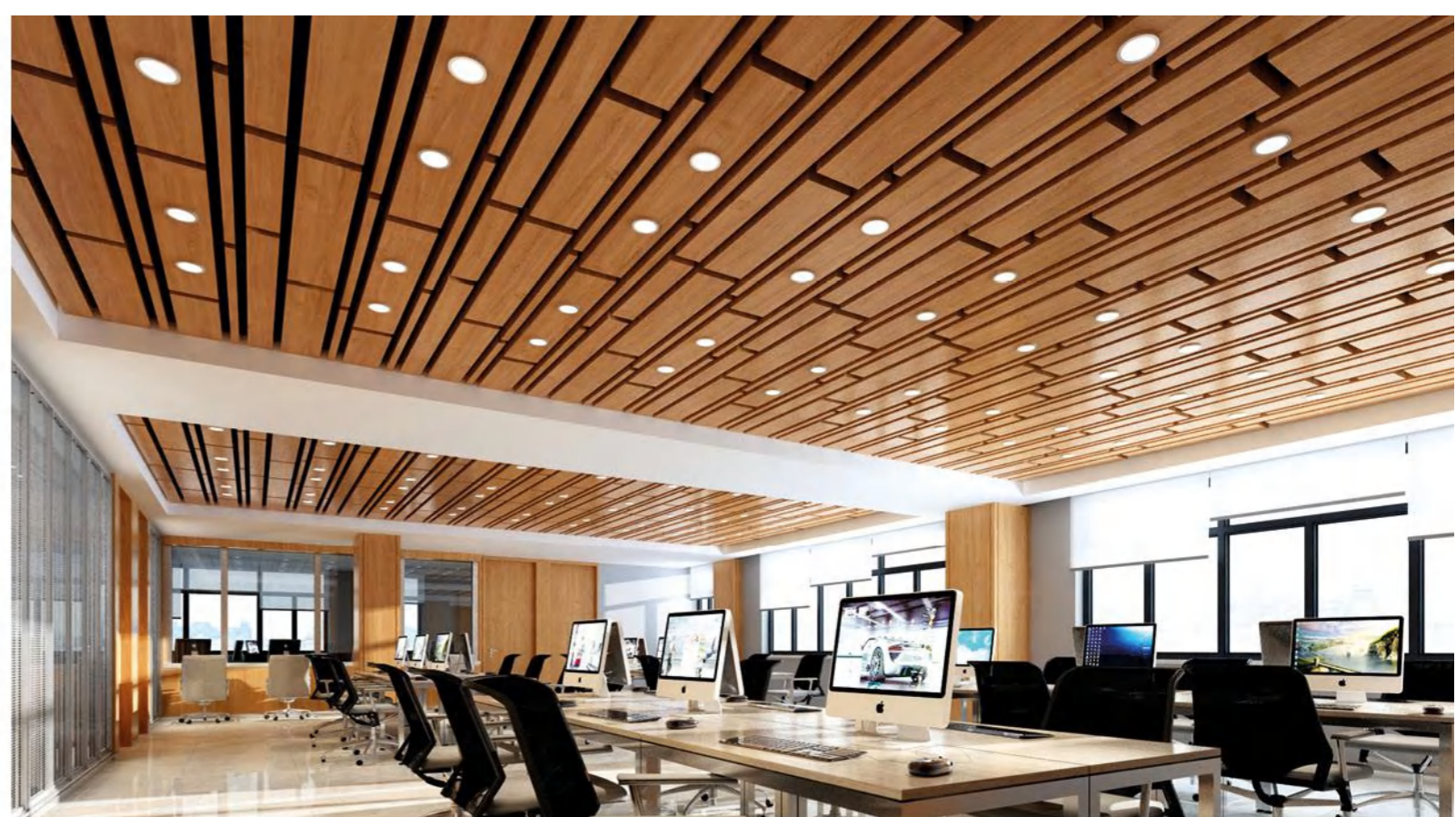

Wood color effect

* YCCY-017 Blended groove ceiling



White color effect

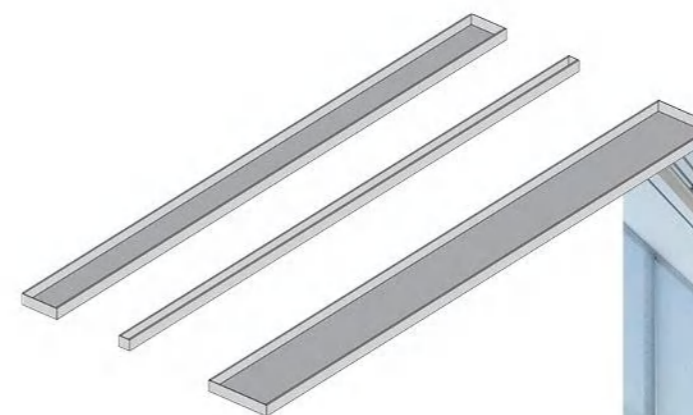

Large groove specification:
200mm width*40mm height*2000mm length

Medium groove specification:
120mm width*40mm height*2000mm length

Small groove specification:
40mm width*40mm height*2000mm length



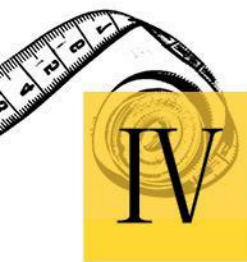

THE CUSTOMIZED PANEL

* YCDB-001 Assembled ring model

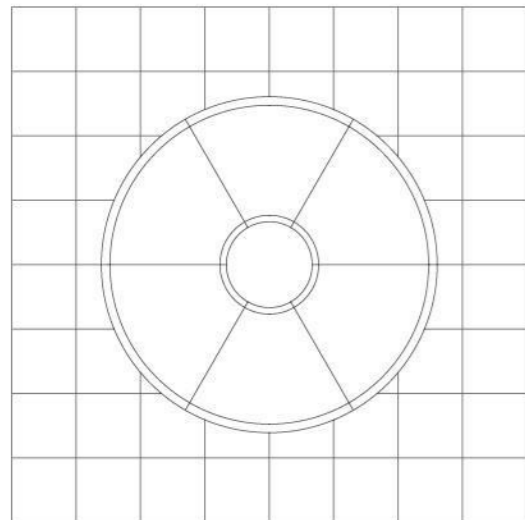

Multiple projects using aluminum panel with lighting technology can create multiple possibilities. By selecting the panel model and LED punching pattern, used with plain panel, creating a high-end and exquisite space.

<PATENTED PRODUCT>

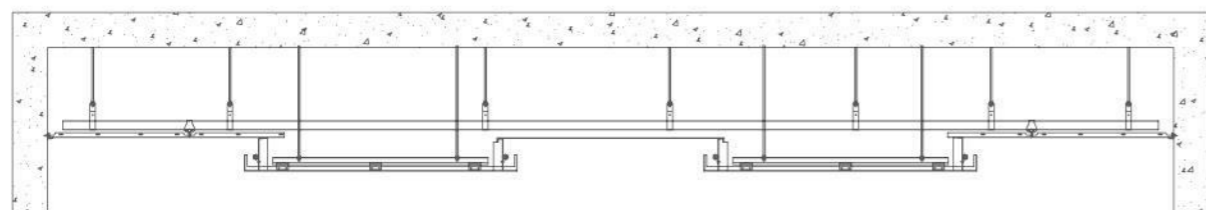

Available punching patterns (LED lights)

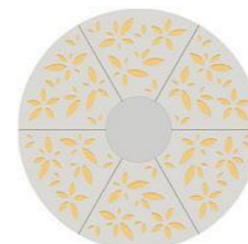

YCDB-112-01

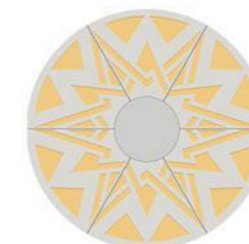

YCDB-112-02

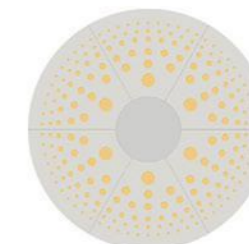

YCDB-112-03

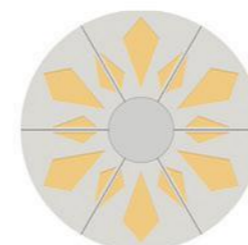

YCDB-112-04

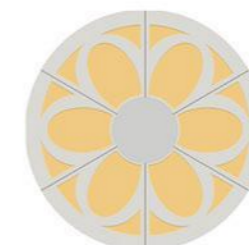

YCDB-112-05

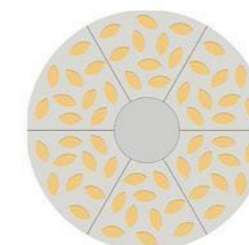

YCDB-112-06

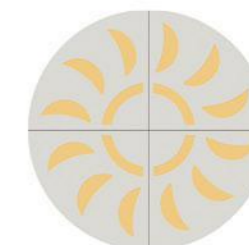

YCDB-112-07



YCDB-112-08

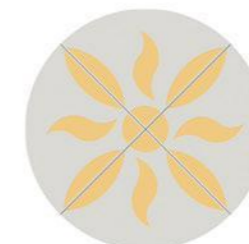

YCDB-112-09

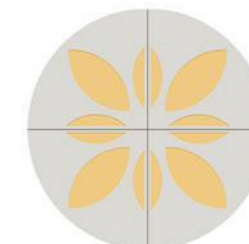

YCDB-112-10

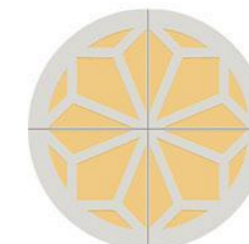

YCDB-112-11

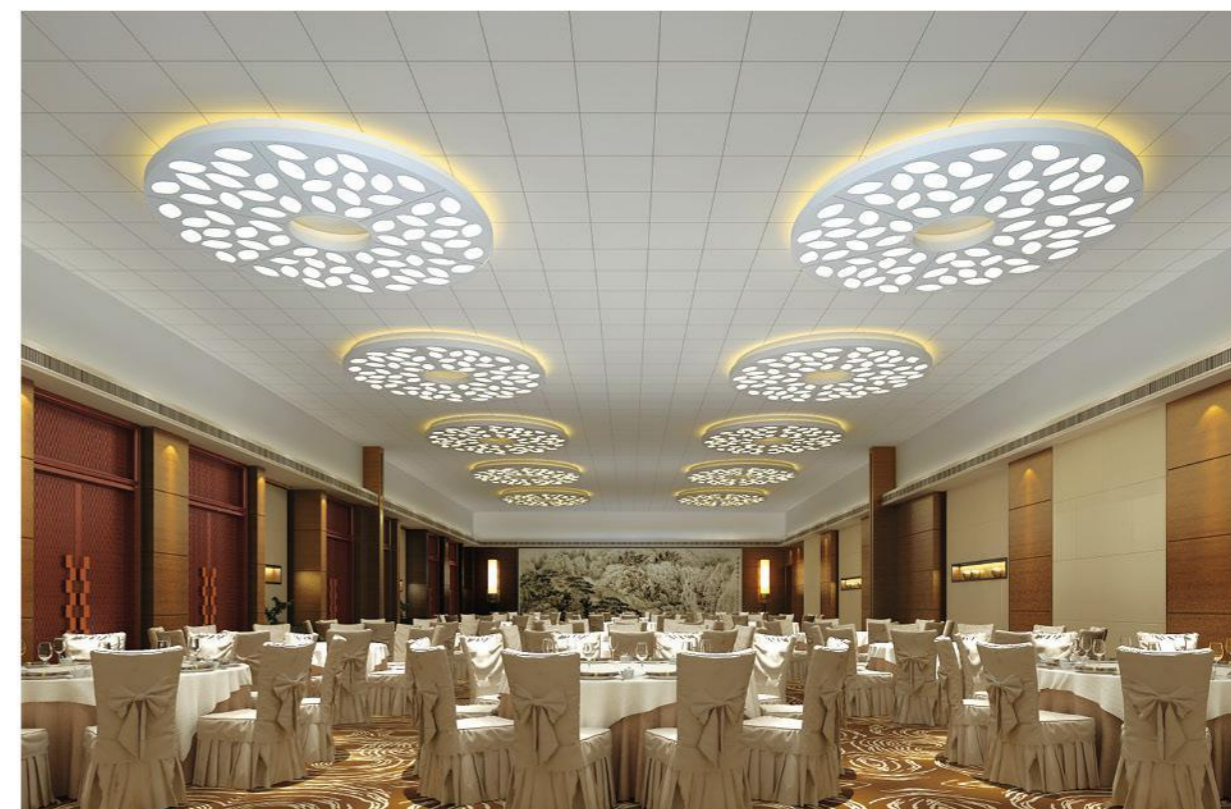

* YCDB-002 Assembled oval model

Available punching patterns (LED lights)

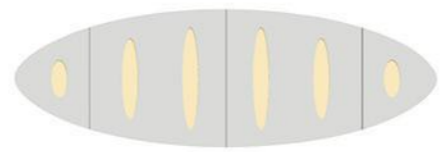
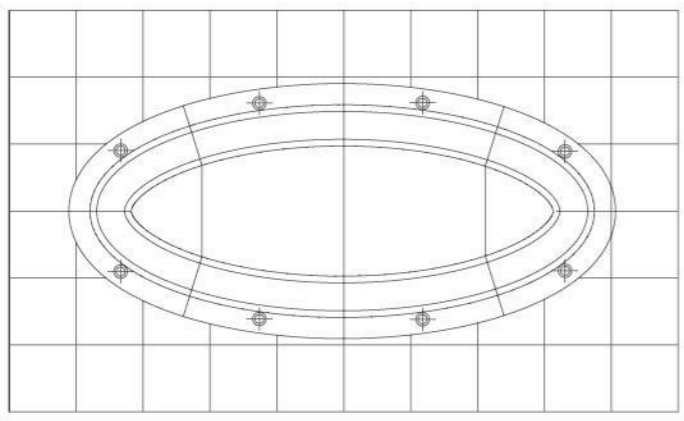

YCDB-002-01

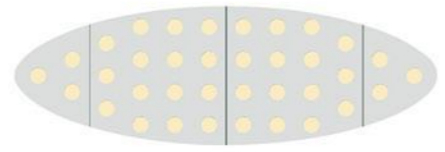

YCDB-002-02



YCDB-002-03



YCDB-002-04



YCDB-002-05

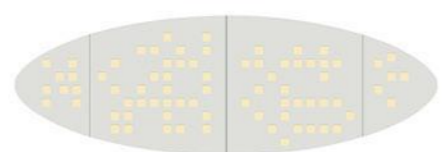

YCDB-002-06



* YCDB-003 Telescoped triangle panel model

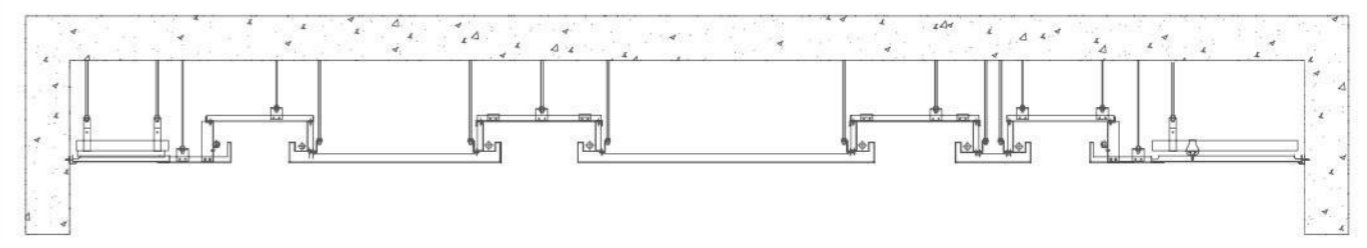
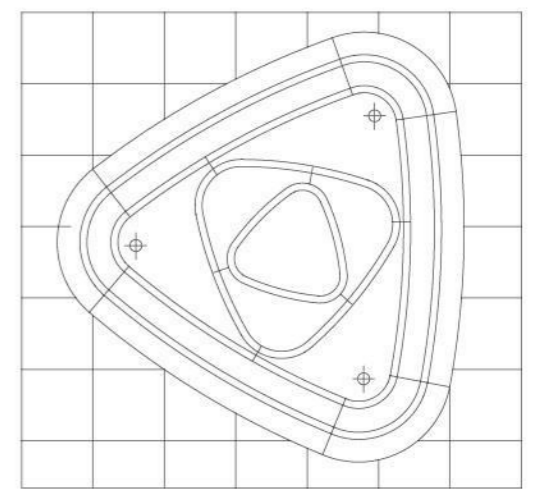

* YCDB-004
Reversed arc panel

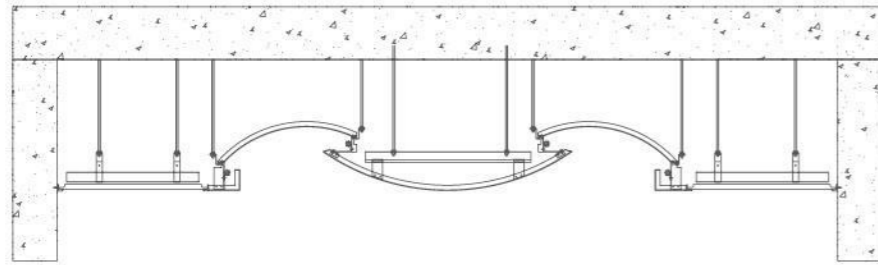
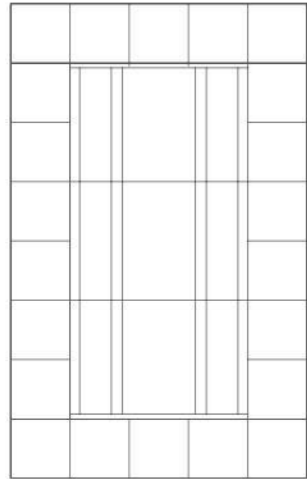

Available punching patterns(LED lights)

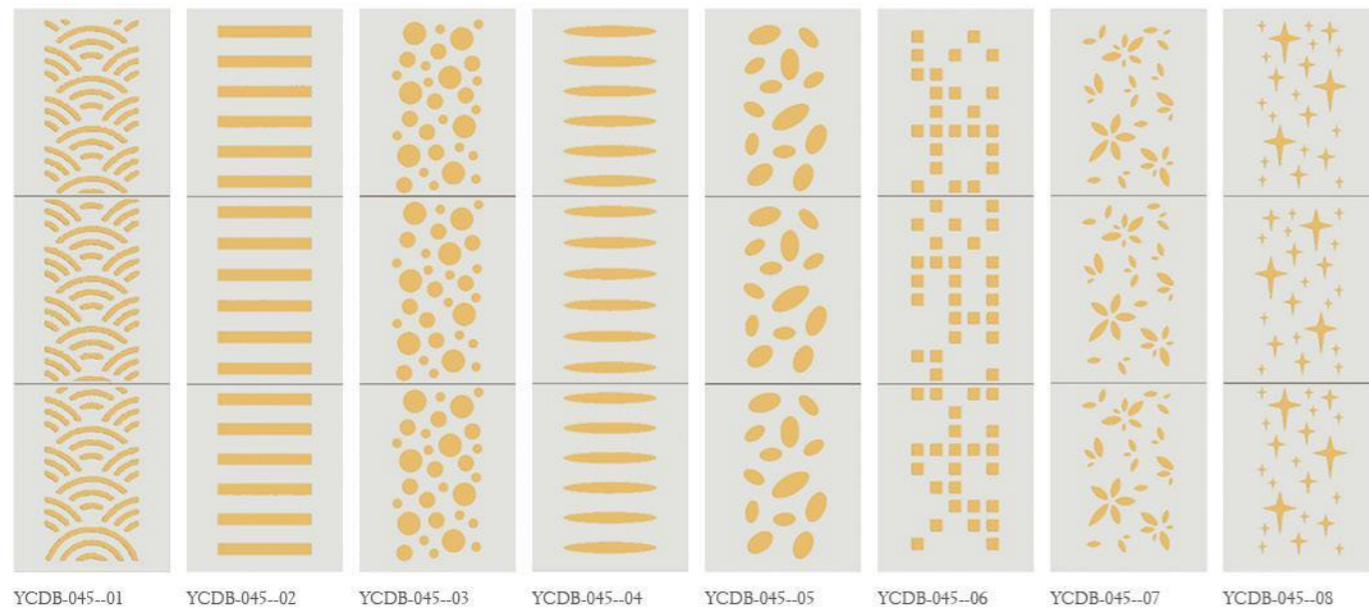

* YCDB-005 Secund arc panel

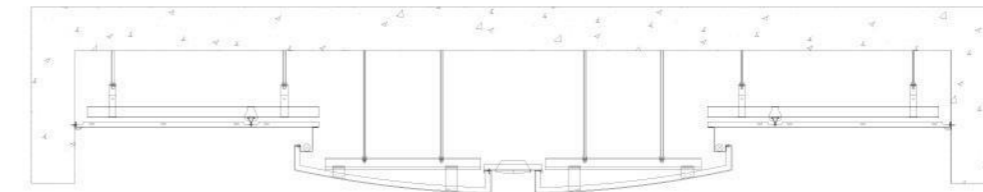
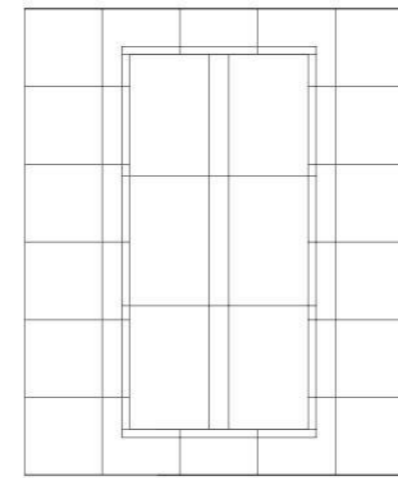

* YCDB-006 Arch groove ceiling model

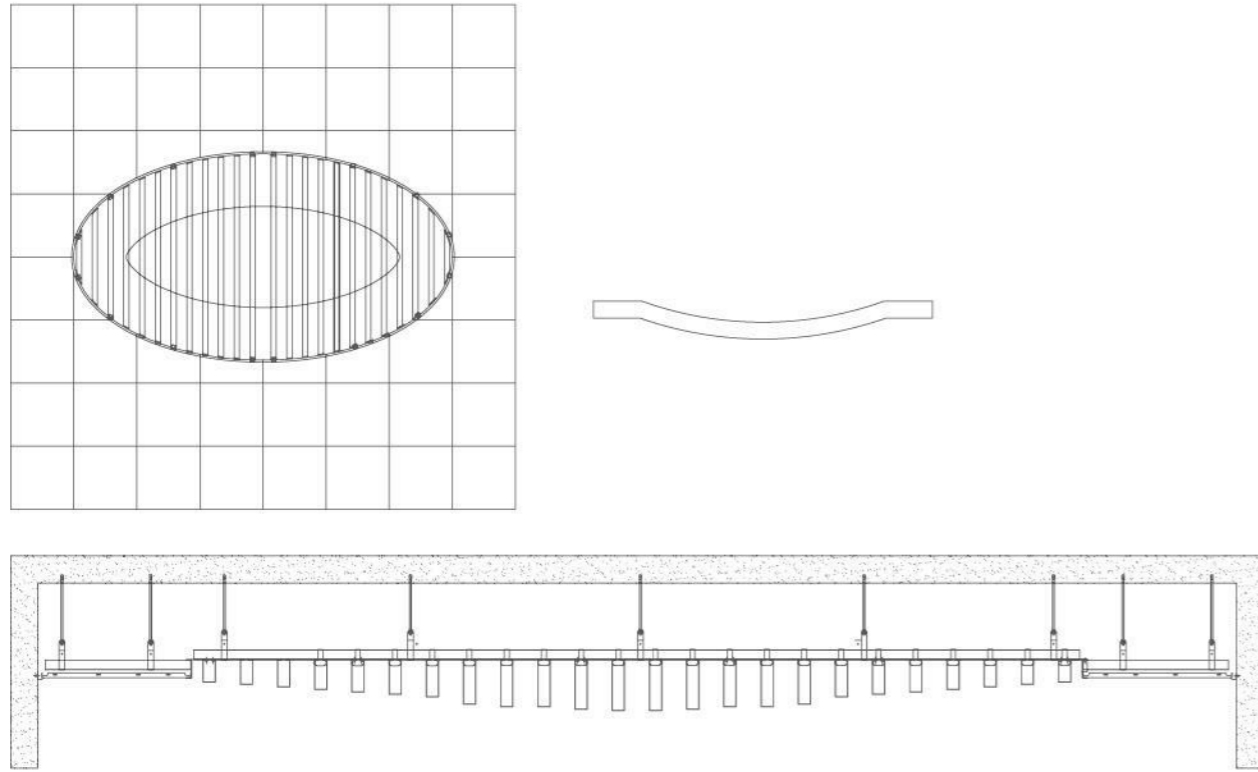

* YCDB-007 Stereo triangle panel

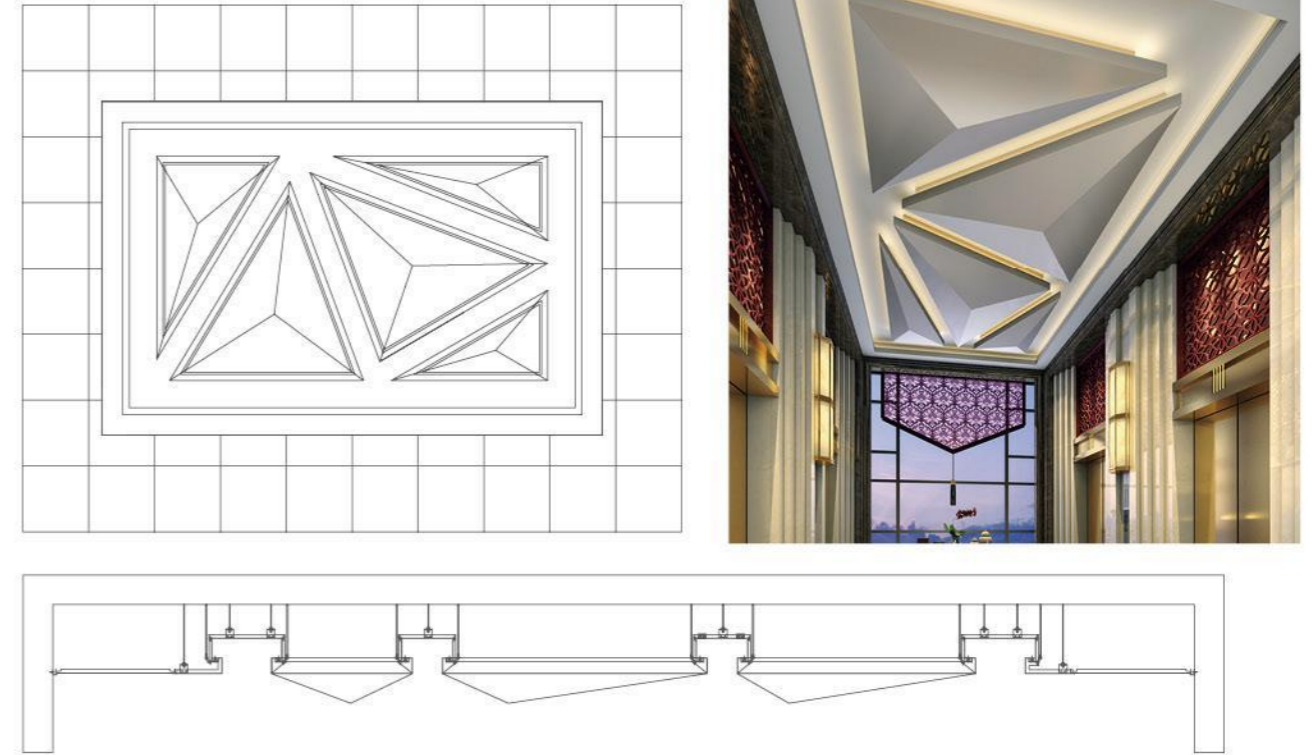

✦ YCDB-008 Geometric panel

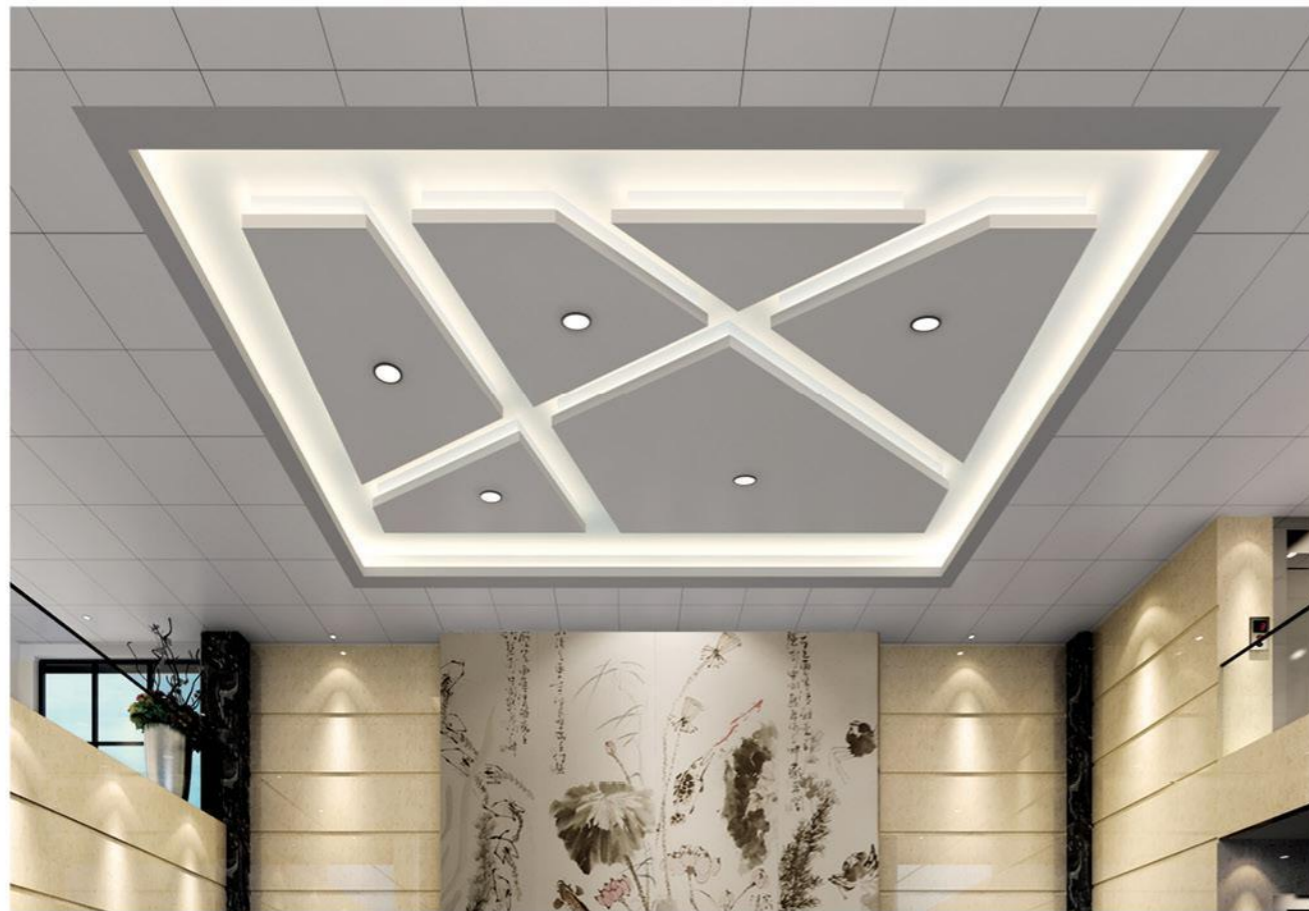
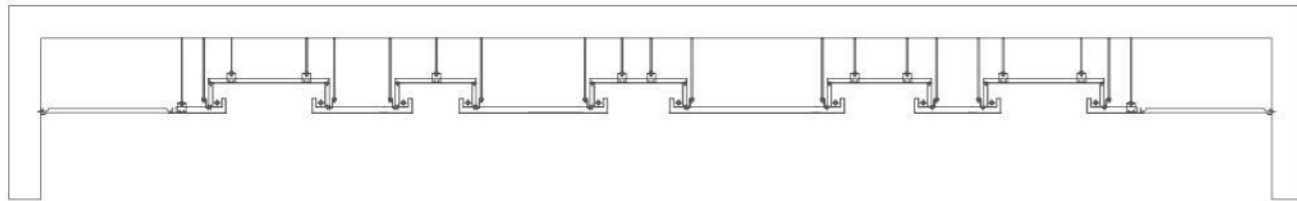
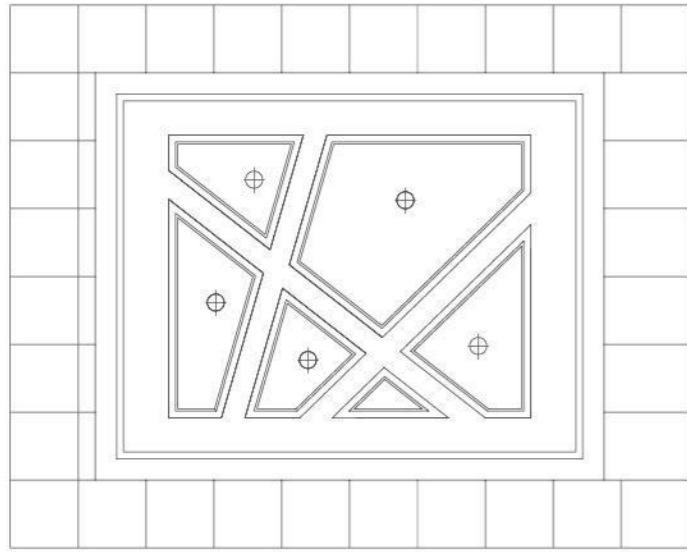

✦ YCDB-009 Bilaminar round model

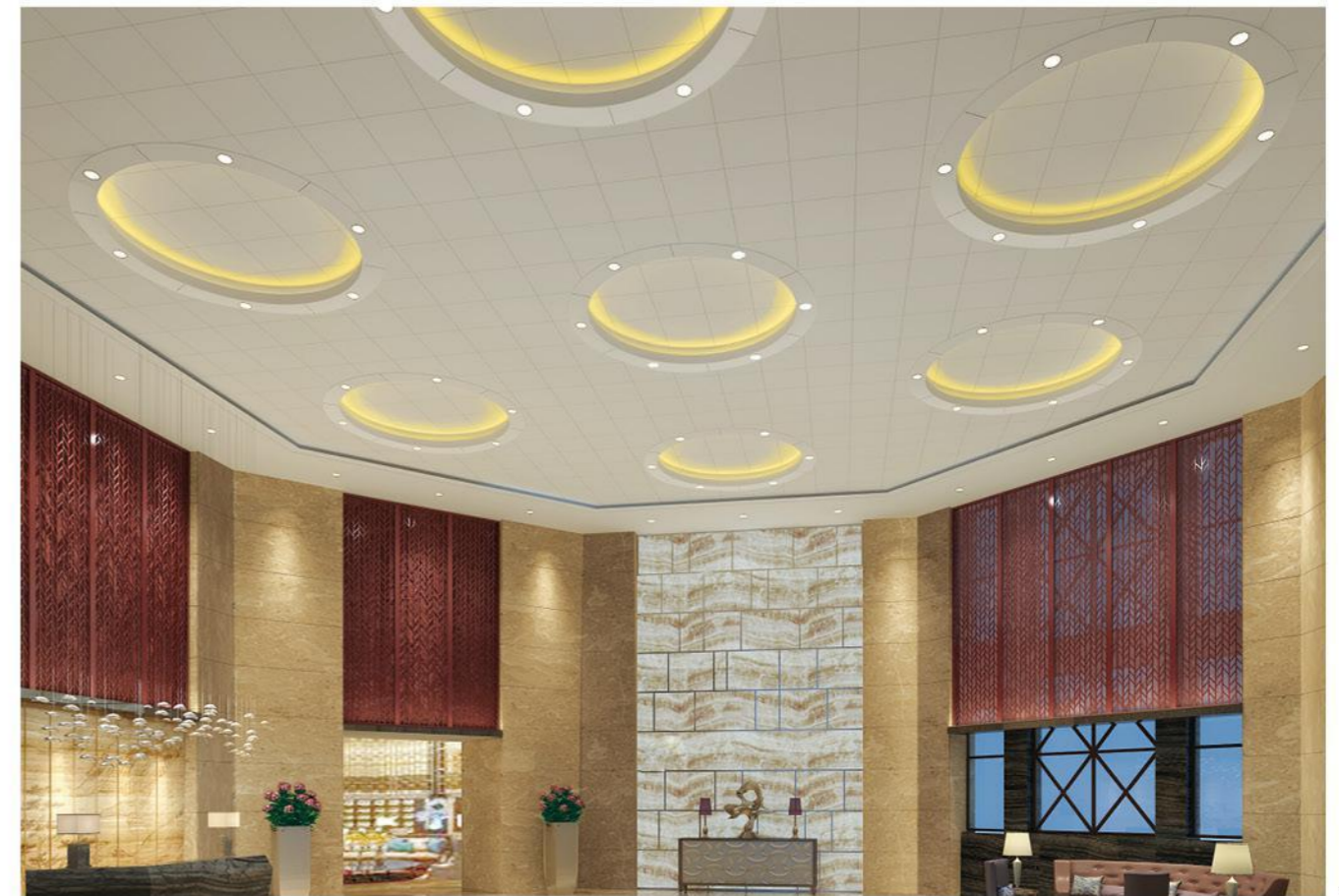
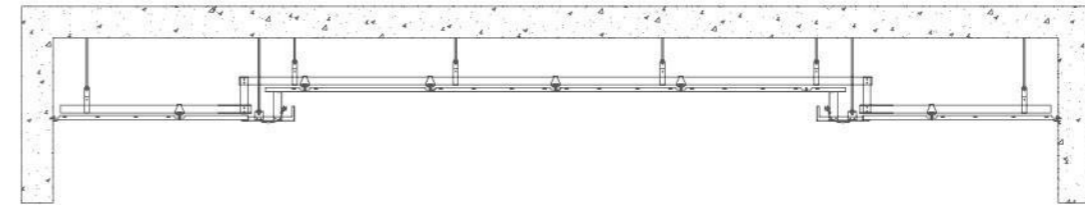
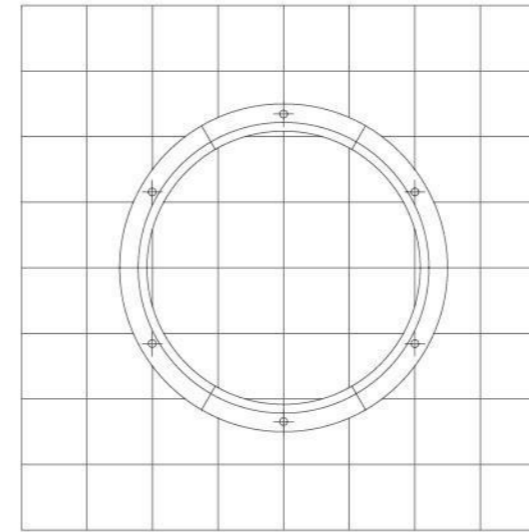

* YCDB-010 Bilaminar oval model

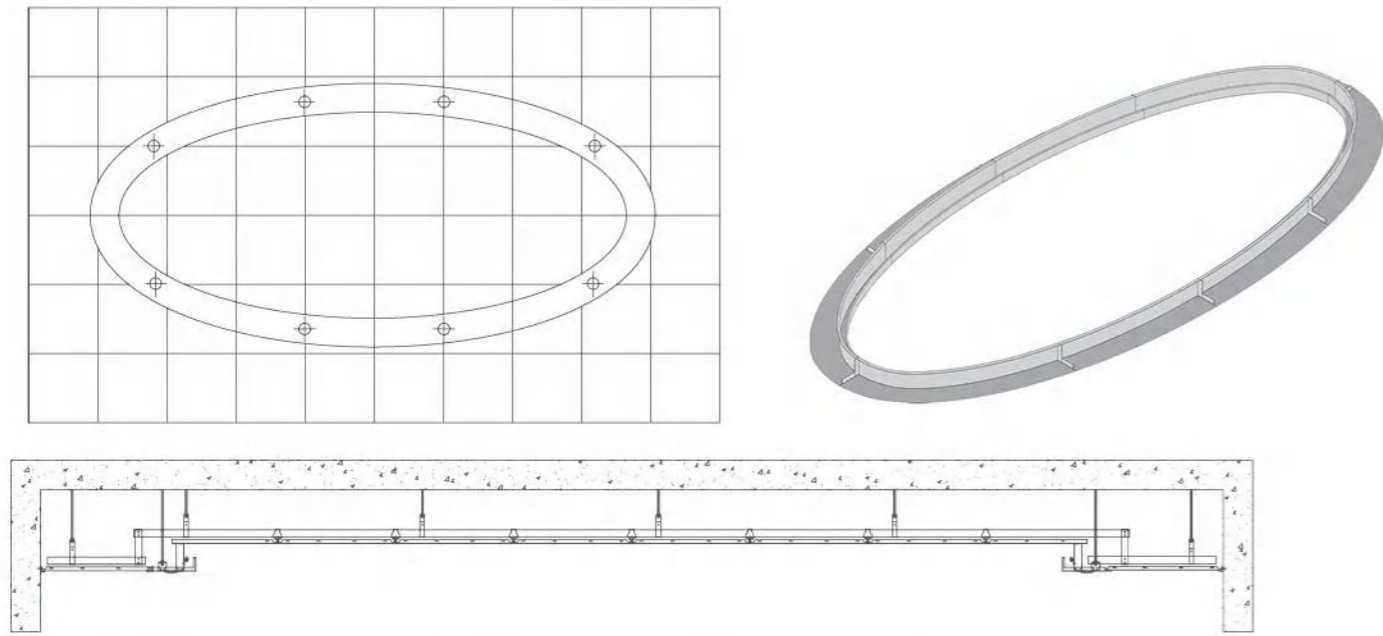

* YCDB-011 Bilaminar triangle model

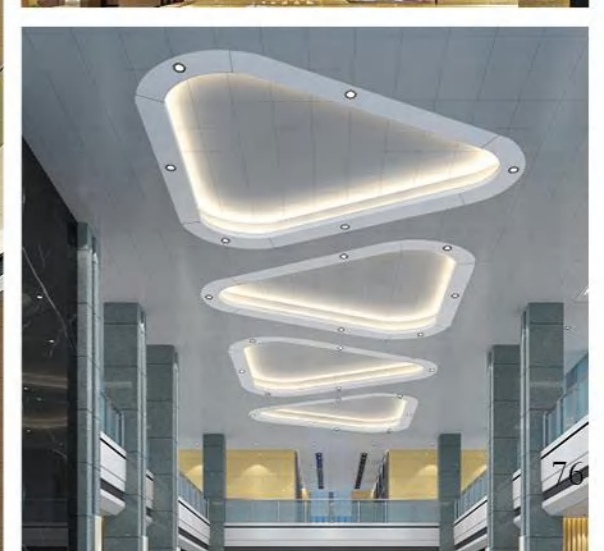
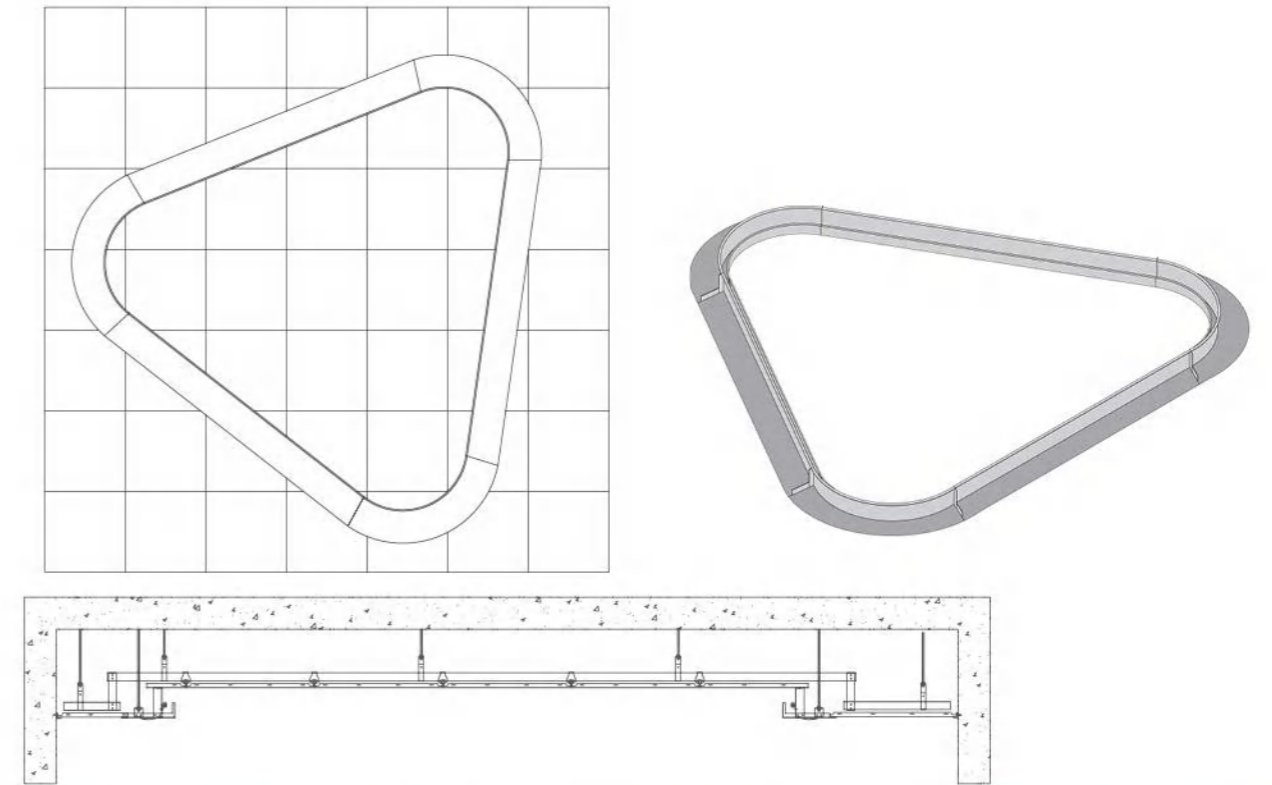

* YCDB-012
Assembled round
panel model

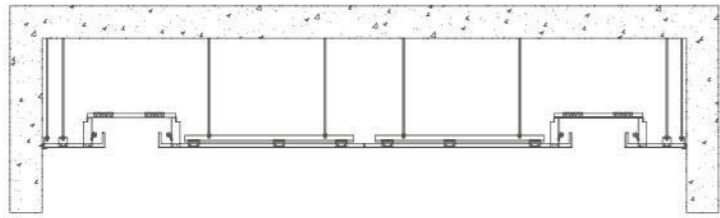
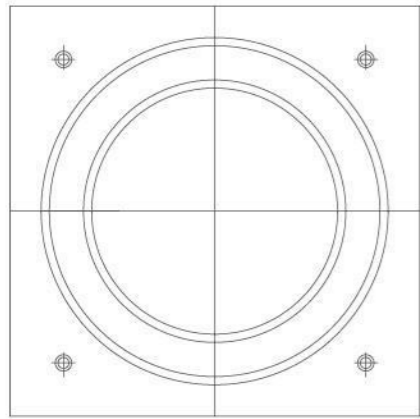

Available punching patterns
(LED lights)

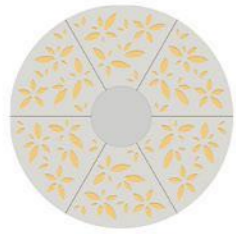

YCDB-112-01

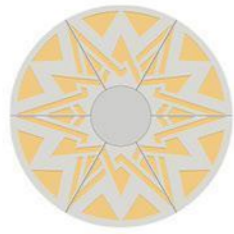

YCDB-112-02

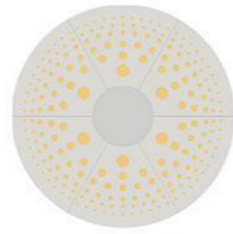

YCDB-112-03

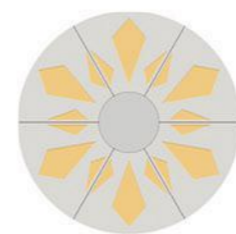

YCDB-112-04

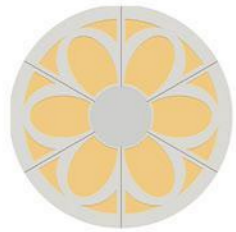

YCDB-112-05

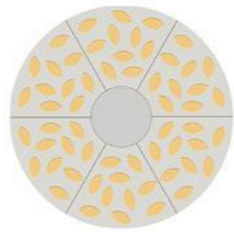

YCDB-112-06

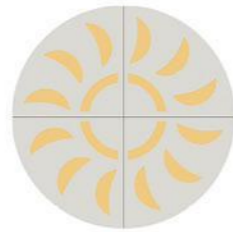

YCDB-112-07

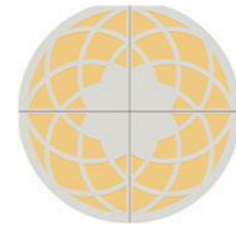

YCDB-112-08



YCDB-112-09

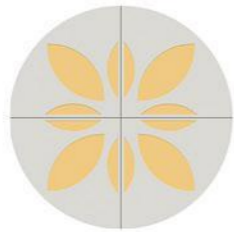

YCDB-112-10



YCDB-112-11

* YCDB-013 Bilaminar curved model

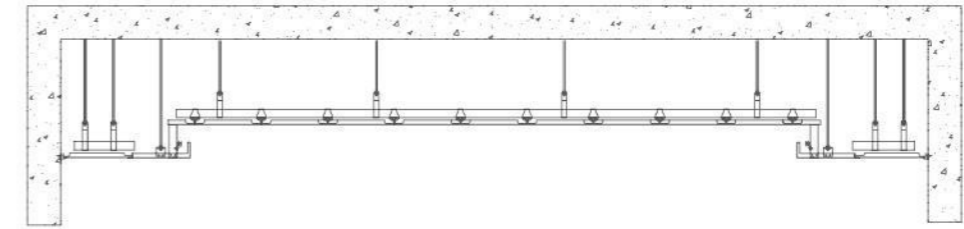
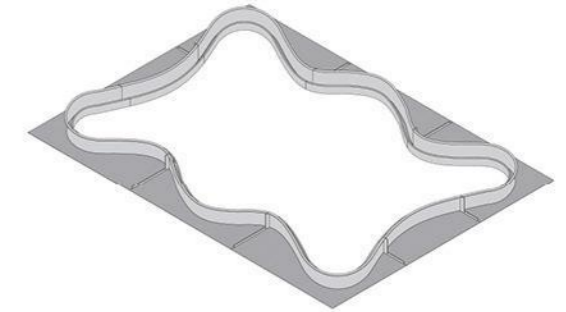
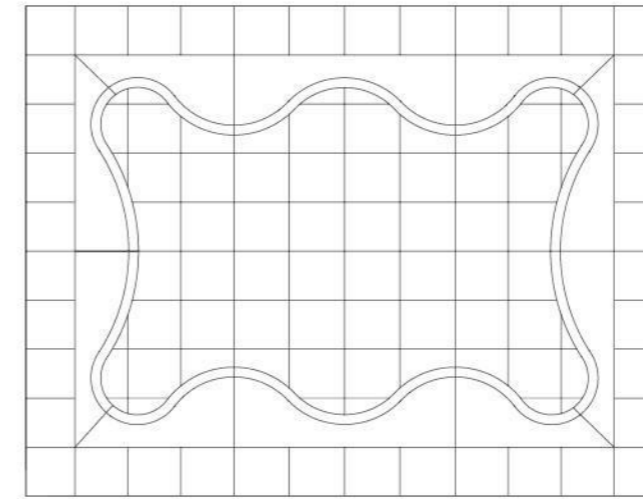

* YCDB-014 Diamond panel

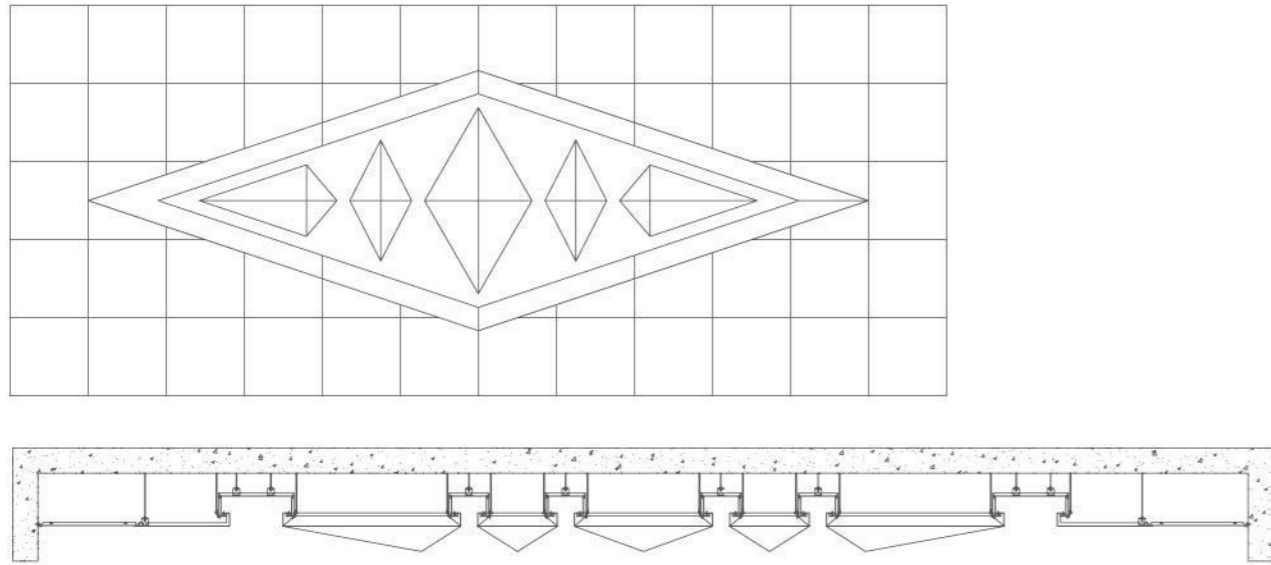

* YCDB-015 Arc corner panel

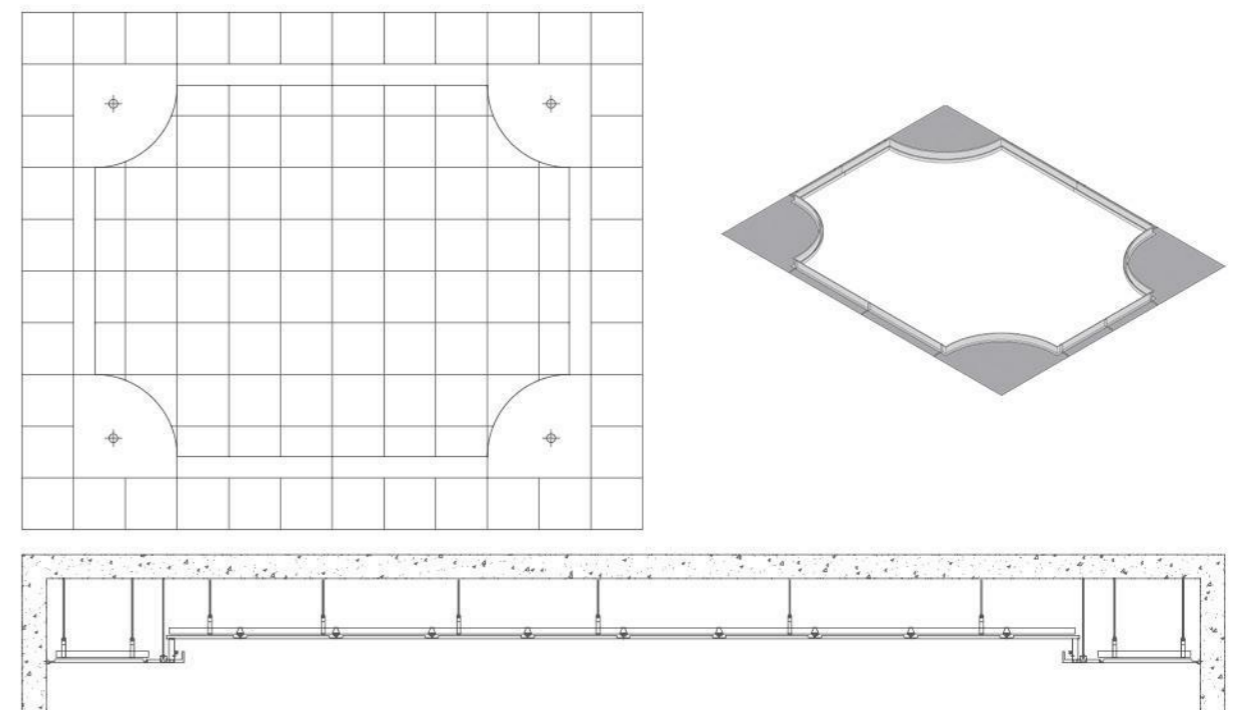

✦ YCDB-016 Telescoped square panel model



YCDB-017 Bilaminar European model



Beside the tradition white color, golden, silver and wood grain are also available

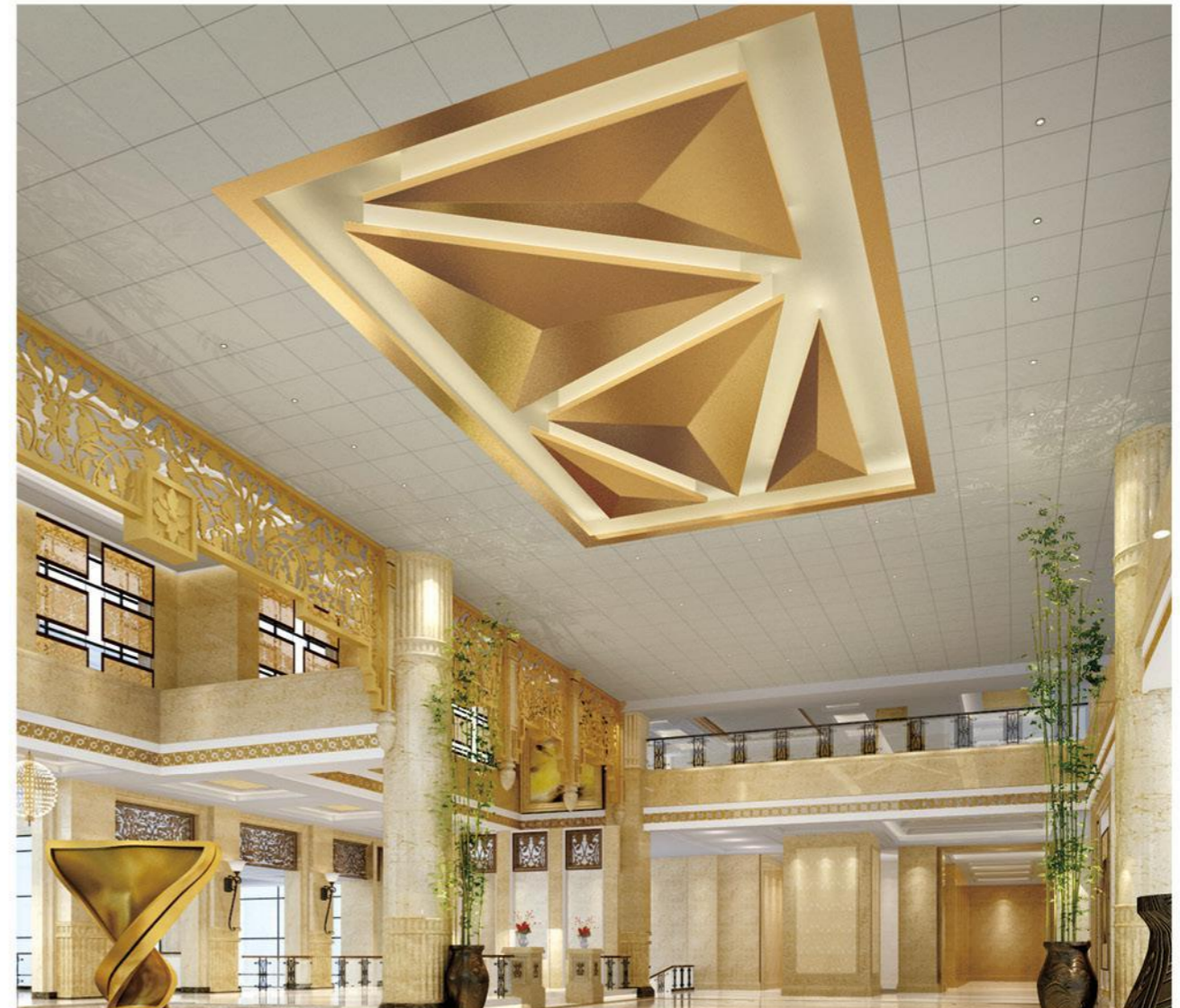

WALL PANEL

* Outdoor Aluminium Wall Panel

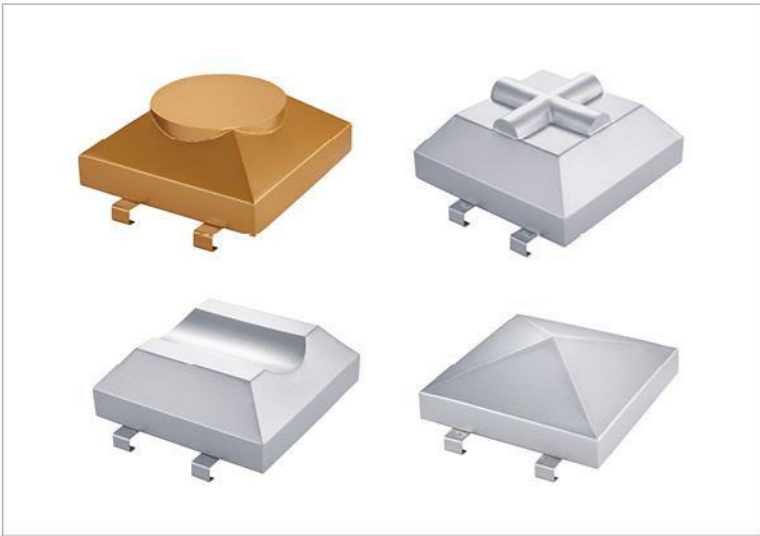

● Generally, the surface is chromized firstly, then the aluminum wall panel is processed by fluorocarbon coating. Fluorocarbon coating has outstanding characteristics of resistance. Besides, it has good performance of thermal and cold endurance, meanwhile, resisting strong ultraviolet ray, the characteristic can prevent it from fading or pulverizing, thus the product remains for a long time.

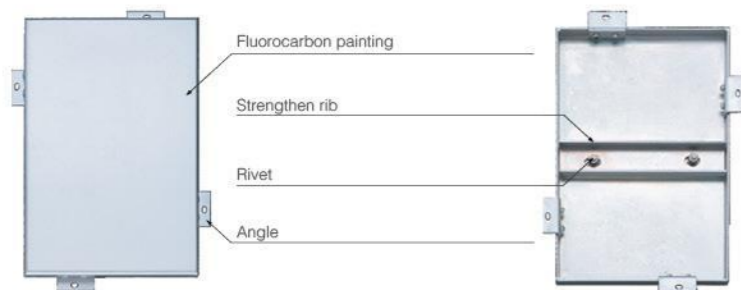

Instruction

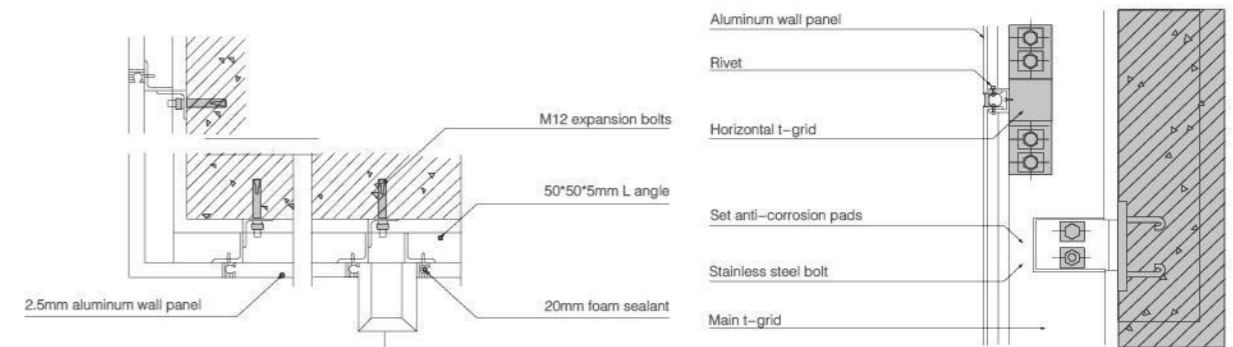

WALL PANEL

* Indoor Aluminium Wall Panel

Instruction

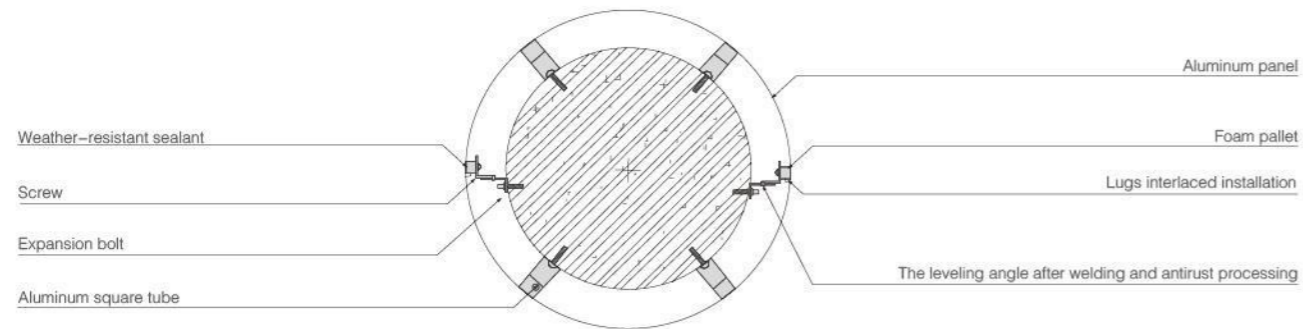

- Indoor aluminium wall panel is made by processing AA grade aluminium alloy, firstly pre-treated, then coated with fluorocarbon, the integration of modern element and any other innovative ideas, makes the building more fashionable.
- Suitable for beam-columns, clapboard decorations, lobby facades, roof ceilings, indoor walls, interior decorations of vehicle show room, large suspended ceilings and so on.

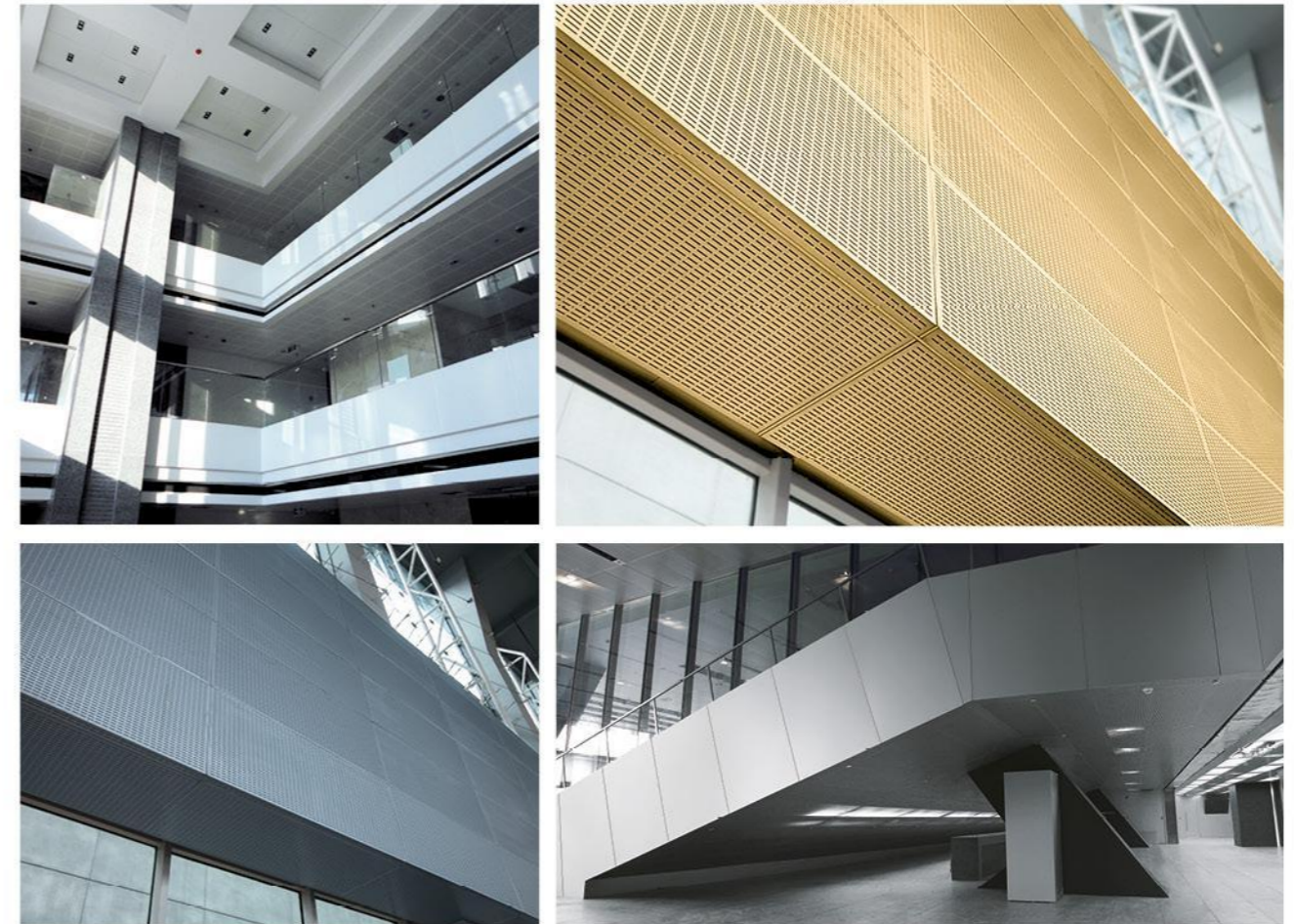

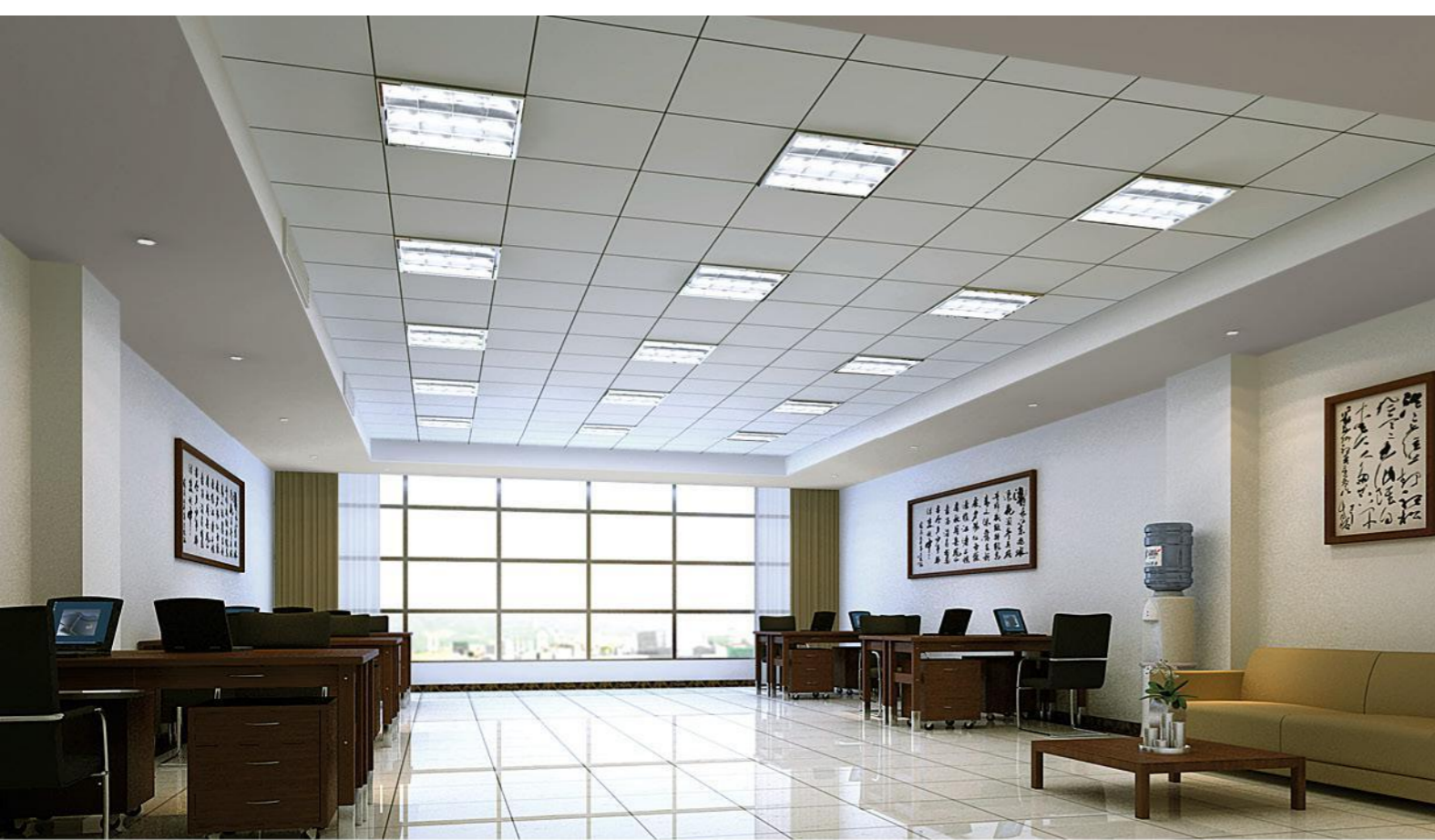

※ Aluminum Clip-in Ceiling

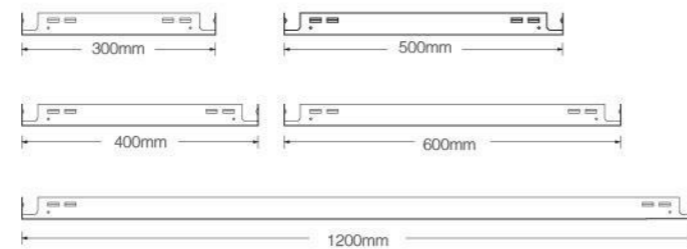

Specification (W x L)	300*300mm 600*600mm 600*1200mm	400*400mm 300*600mm	500*500mm 300*1200mm
Thickness(D)	0.6-1.2mm		
Height(H)	25mm	30mm	
Note	plain perforation		
A-shaped t-grid(H)	38mm	50mm	

Instruction(high-edge clip-in)

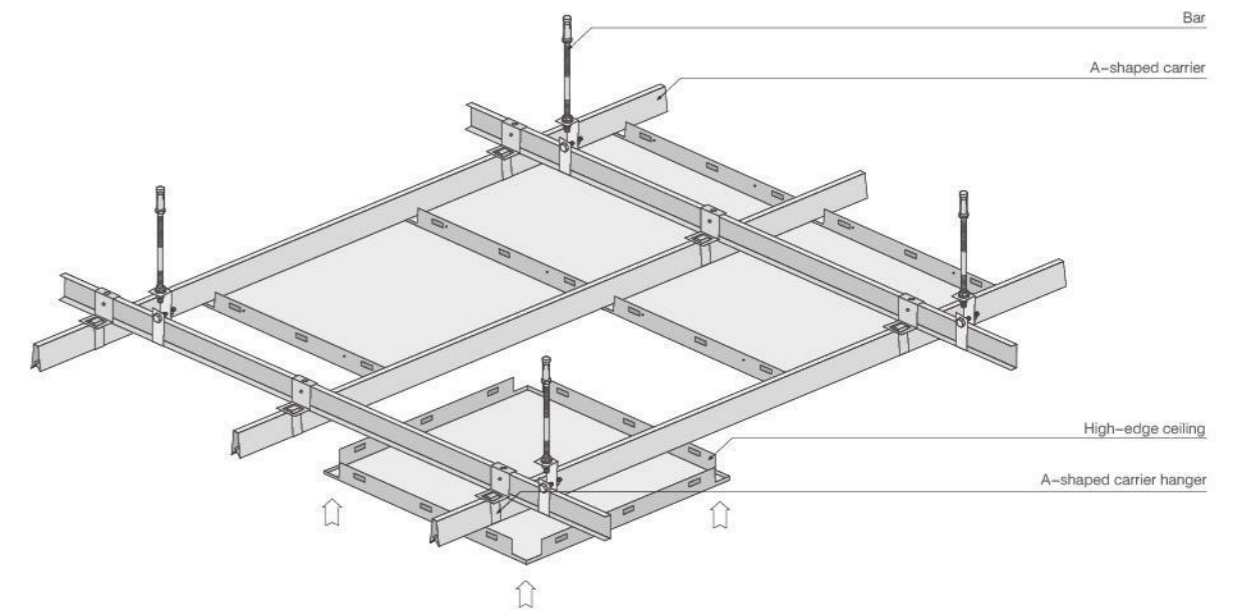

Instruction(low-edge clip-in)

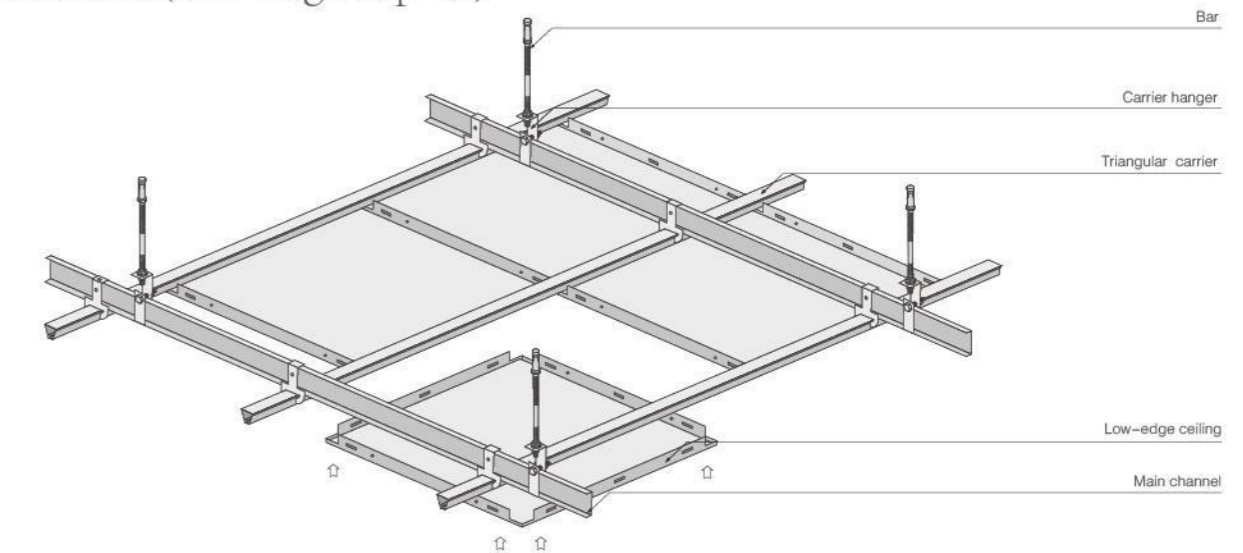

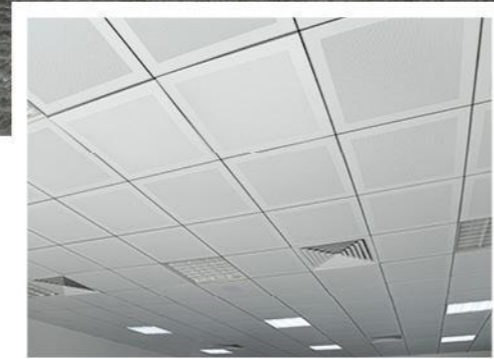

※ Aluminum Lay-In Ceiling

T-grid Series

T-shaped Key T-grid With Varnish Baking

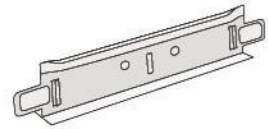

T-shaped Vice T-grid With Varnish Baking

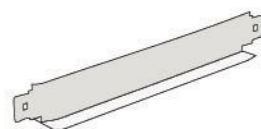

U-shaped Key T-grid With Varnish Baking

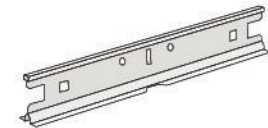

U-shaped Vice T-grid With Varnish Baking

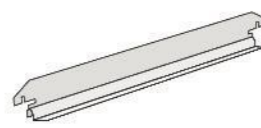

Key T-grid With Varnish Baking of Square Groove Ceiling

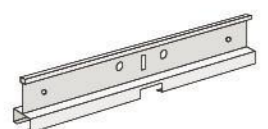

Vice T-grid With Varnish Baking of Square Groove Ceiling

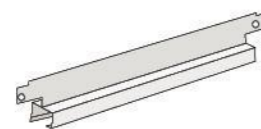

Ceiling down size	575*575mm	585*585mm
Ceiling up size	595*595mm	603*603mm
Thickness(D)	0.5-1.0mm	
Height of side(H)	7mm	8mm 9mm 10mm



Beveled edge lay-in ceiling

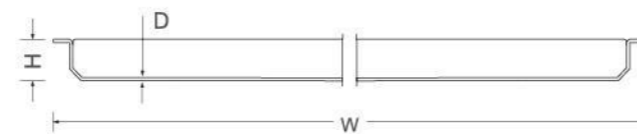

Straight edge lay-in ceiling

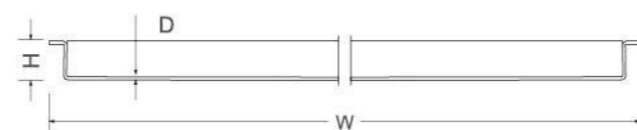

Instruction

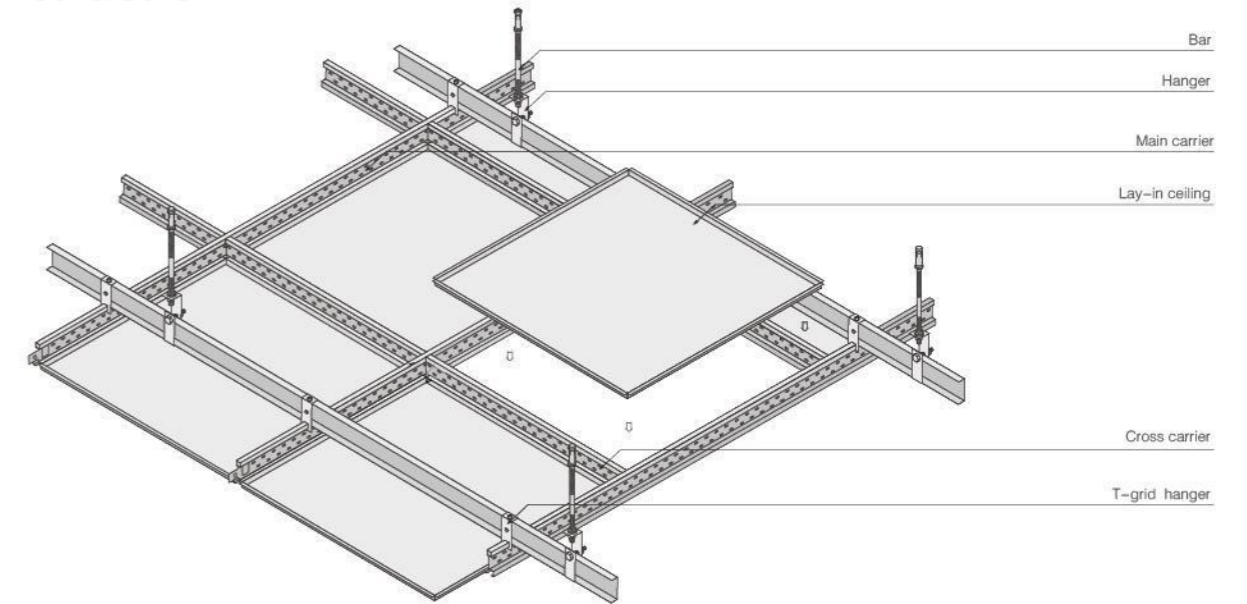

* Aluminum Wekk-Shaped Ceiling

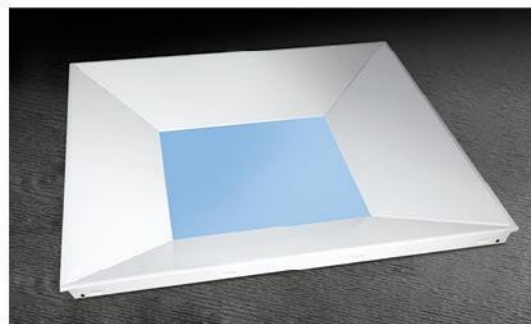

Deep well-shaped ceiling

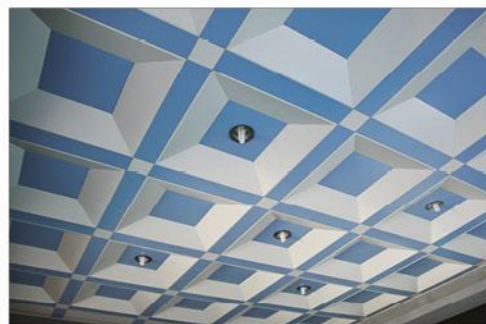

- The well-shaped ceilings break the traditional concept of the ceiling. The well-shaped design is elegant and rich in stereoscopic feeling, with a colourful world spreads out. The movable panel on the top of the well not only can be separately detached, but also can be painted into other colors to form an artistic space, which upgrades the decorative function of the ceiling.
- Suitable for shopping malls, supermarket, gas stations, railway stations, airport, schools, gymnasium, and the lobbies, corridors, toilets and so on.

Instruction

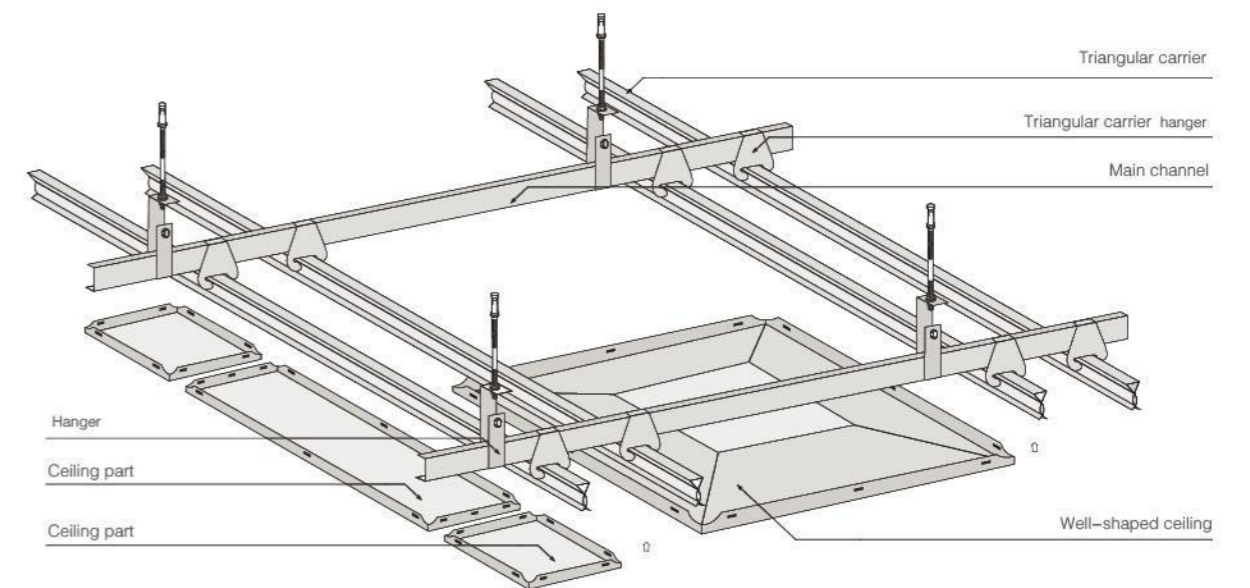

ALUMINUM U-SHAPED GROOVE CEILING

- The aluminum U-shaped groove ceiling, arranged neatly on the same height, makes wide vision, which also convenient for the ventilation, fire sprinklers . The ceiling is firmly installed, easy to assemble and disassemble, collocate well with the lights and convenient for maintenance. Besides, even color of the product can keep unfaded indoor for 10 years.
- Suitable for corridors, bars, libraries, clubs, exhibitions, railway stations, airports, shopping malls, offices and other places.

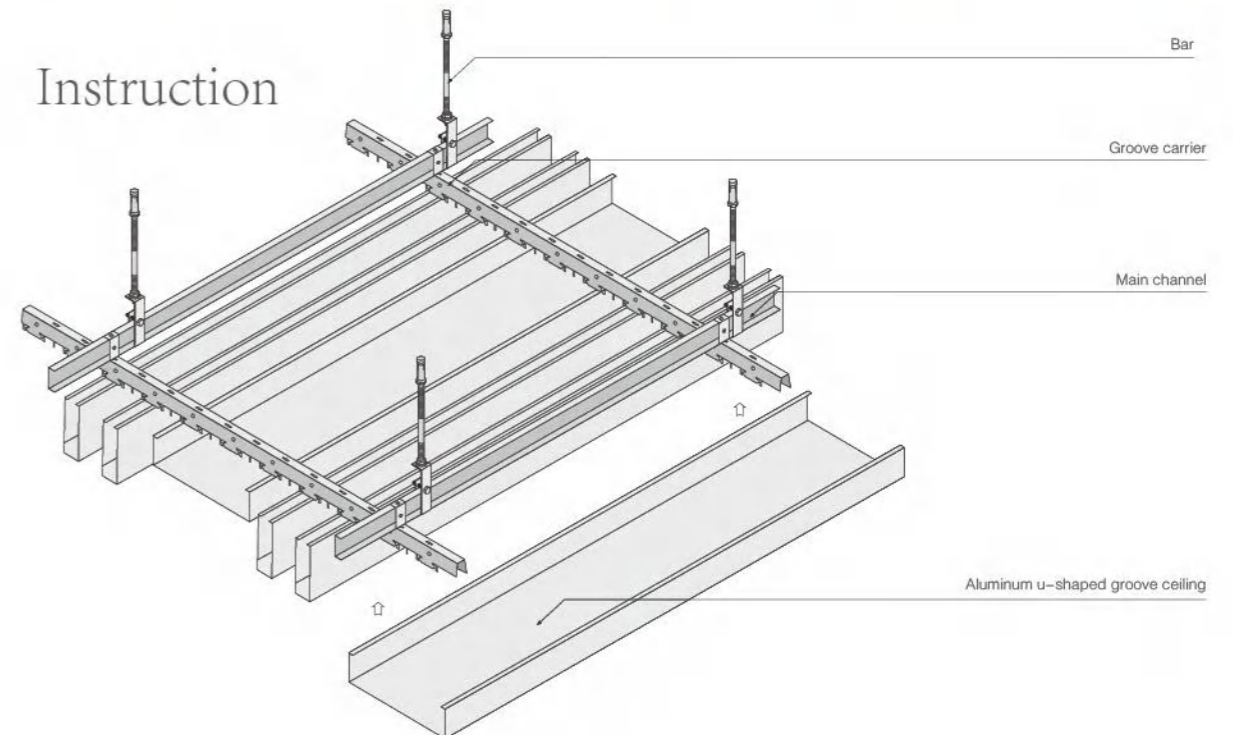
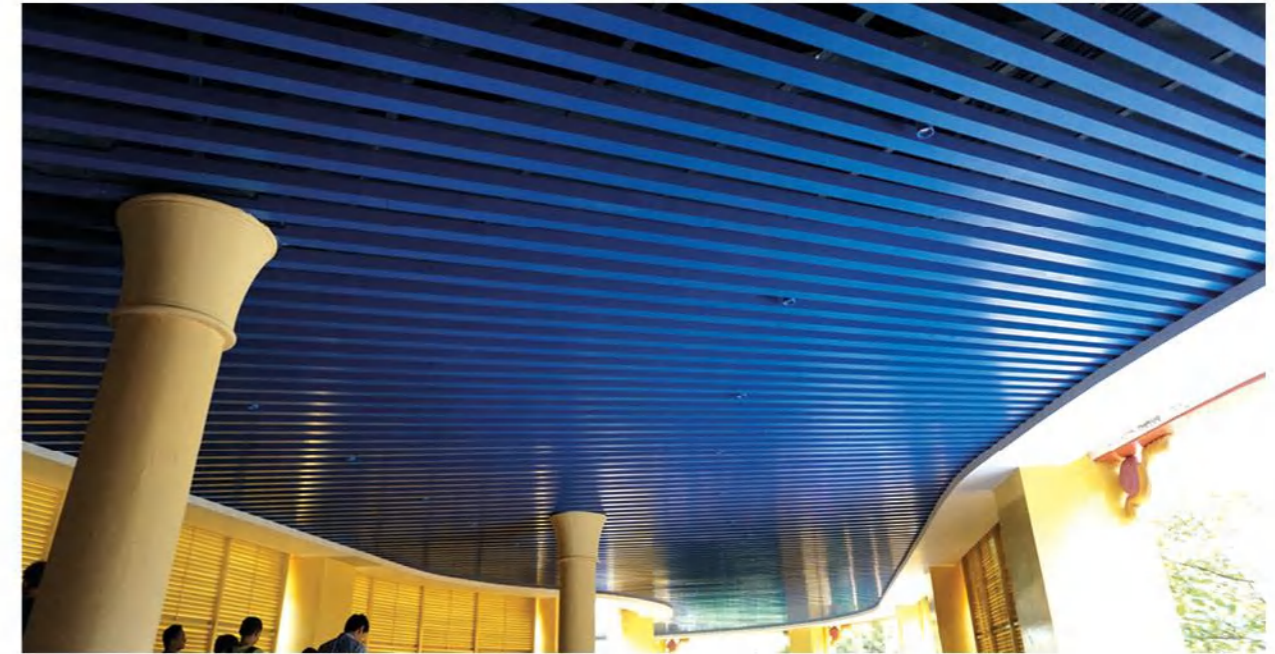



- The aluminum tubular ceiling is the round beam structure, simple and elegant, the streamlined vision which can adjust the visual image and not affecting the fire sprinklers.
- The specialized manufacture, creates an unique visual effect, also, the open structure, makes a wide visual image.

ALUMINUM TUBULAR CEILING

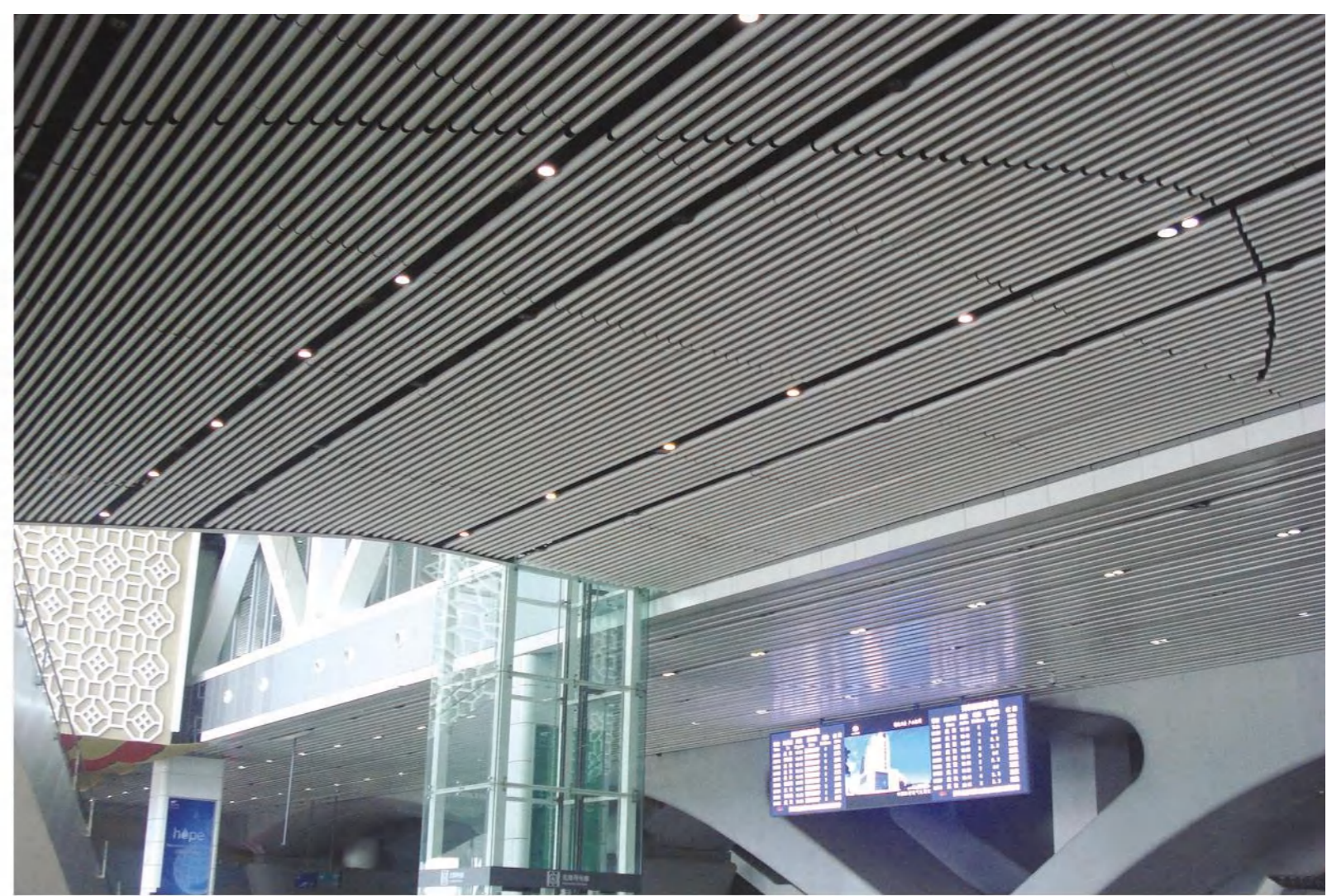
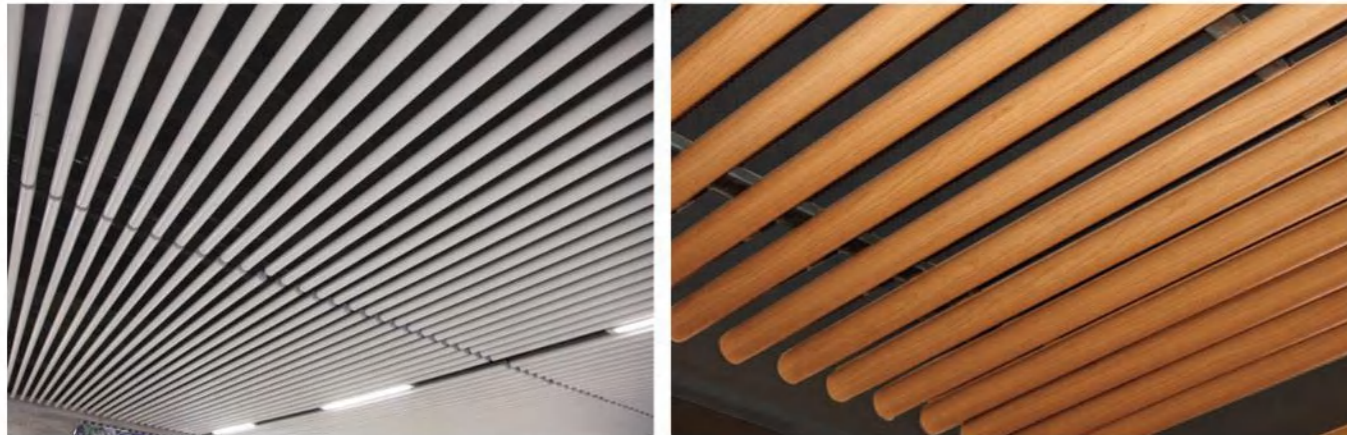
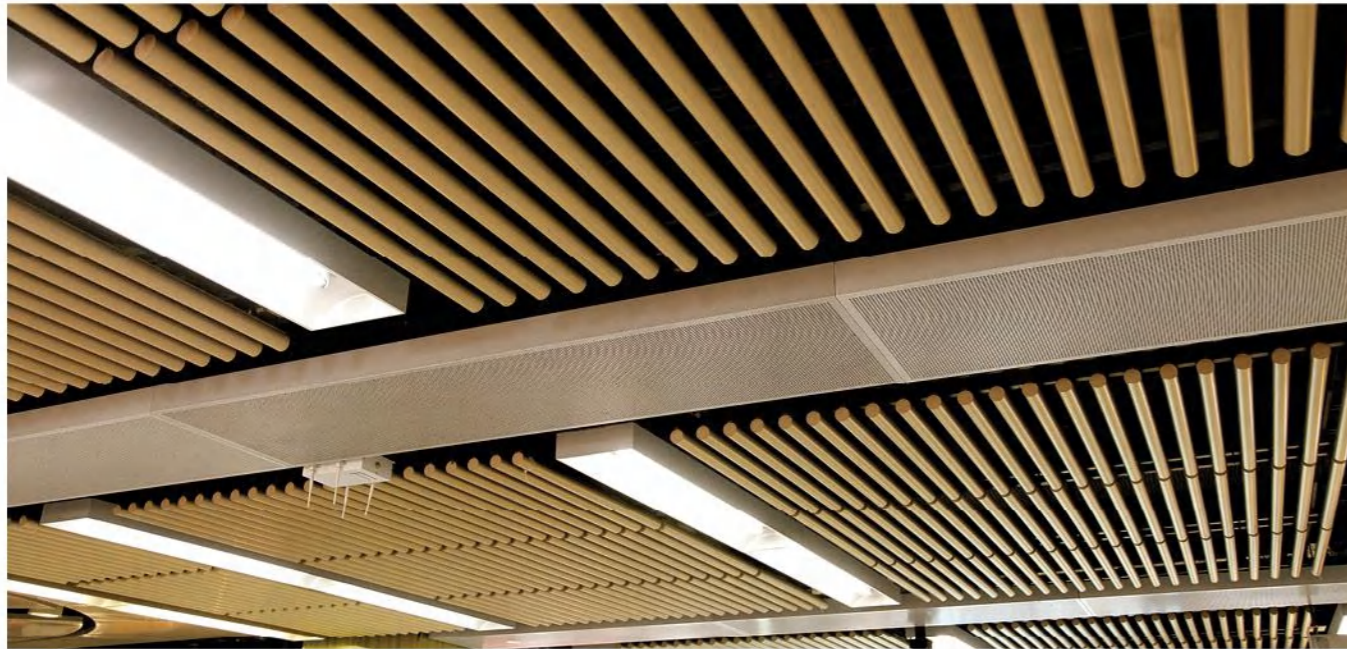

Instruction

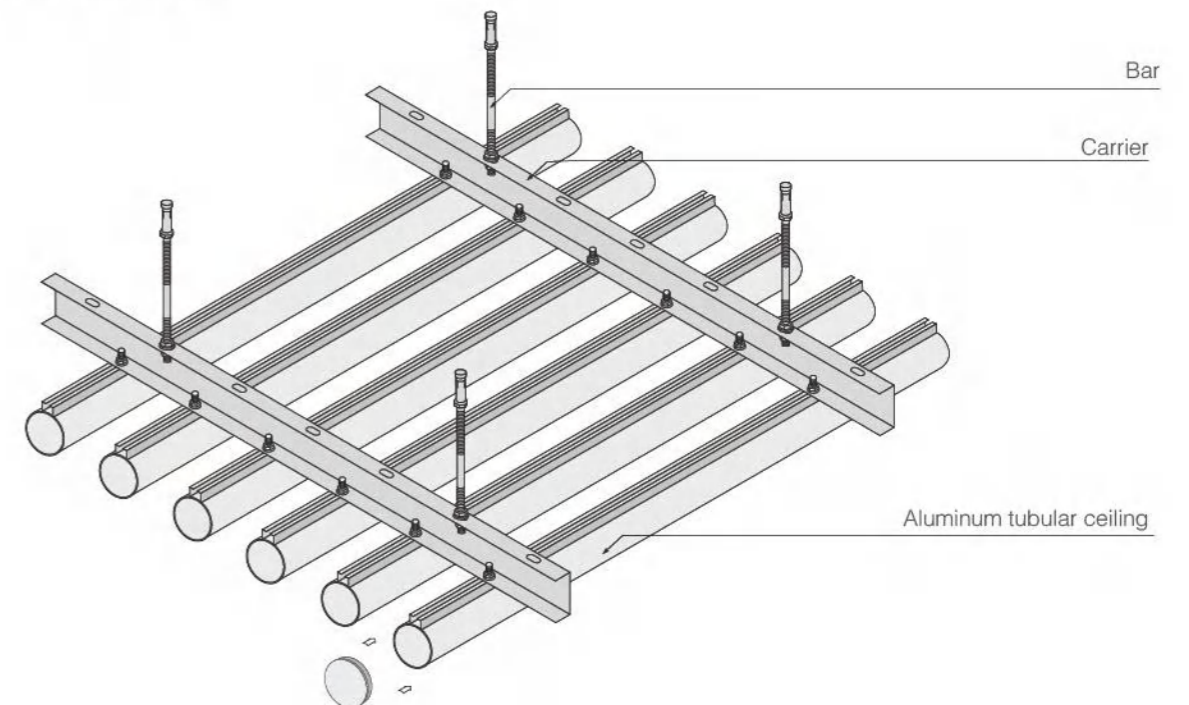

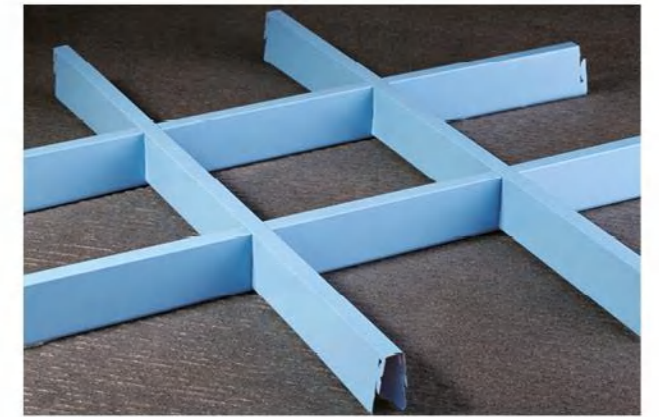
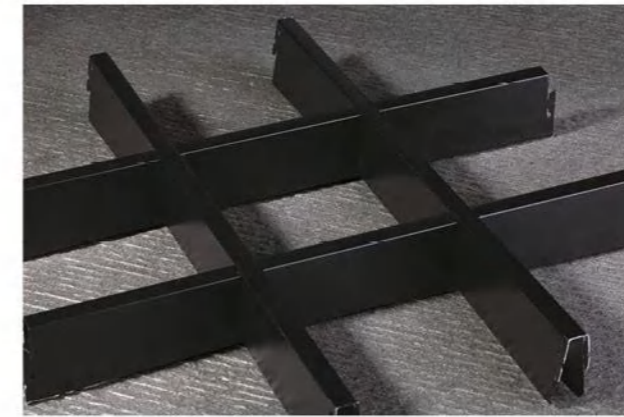

● Aluminum ceiling grid is composed of grid main part, grid vice part and main channel. The grid ceiling is decorative one, which is criss-cross design, unit combination and open style.

● Well-ventilated, fire-proof, easy to install, special layered structure, open stereoscopic feeling, beautiful and colorful.

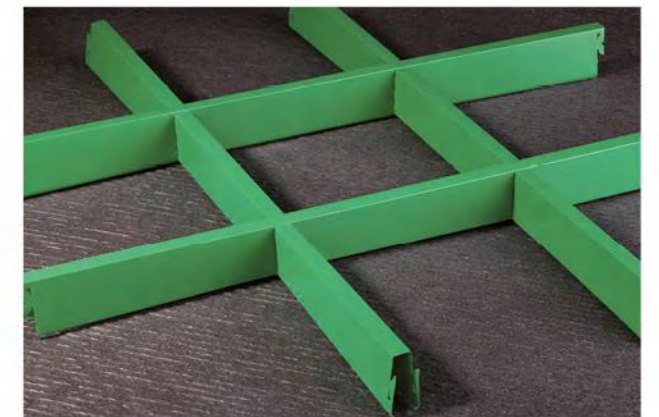
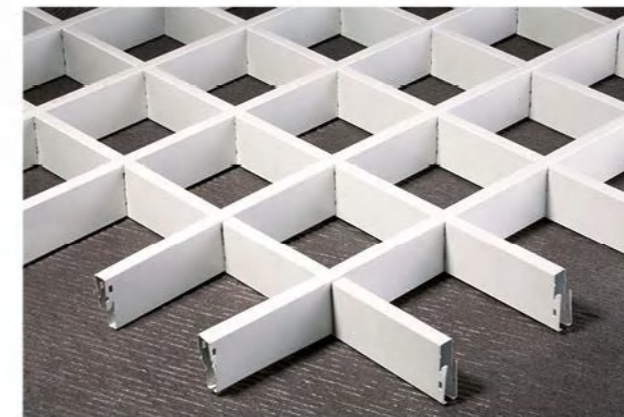

Face width(W)	10mm	15mm	20mm											
Height(H)	30mm	38mm	40mm	45mm	50mm	55mm	60mm	65mm	70mm	80mm	90mm	100mm		
Cell interval(D)	50*50mm	75*75mm	100*100mm	125*125mm	150*150mm	200*200mm	250*250mm	300*300mm						

ALUMINUM GRID CEILING



Instruction

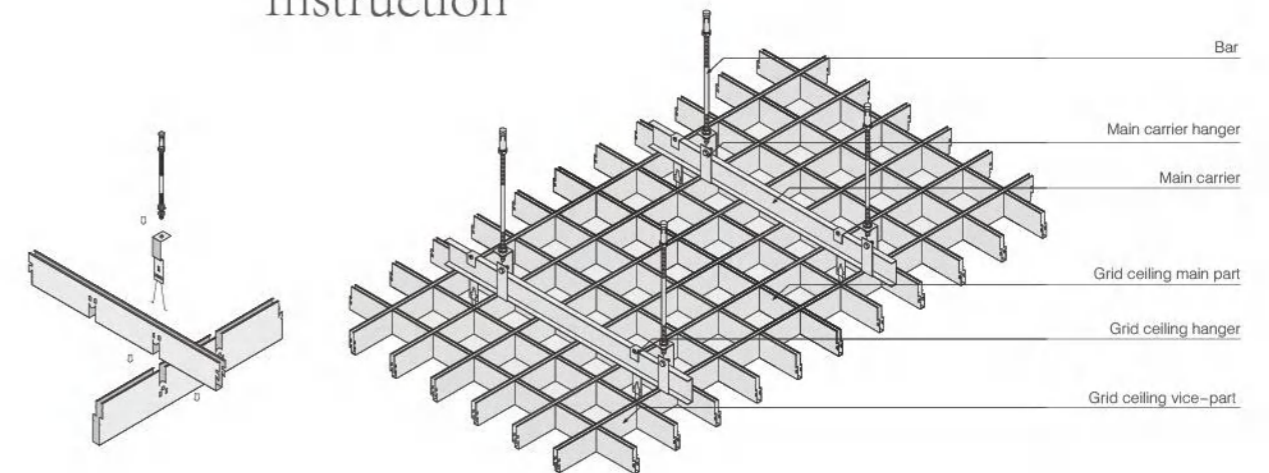

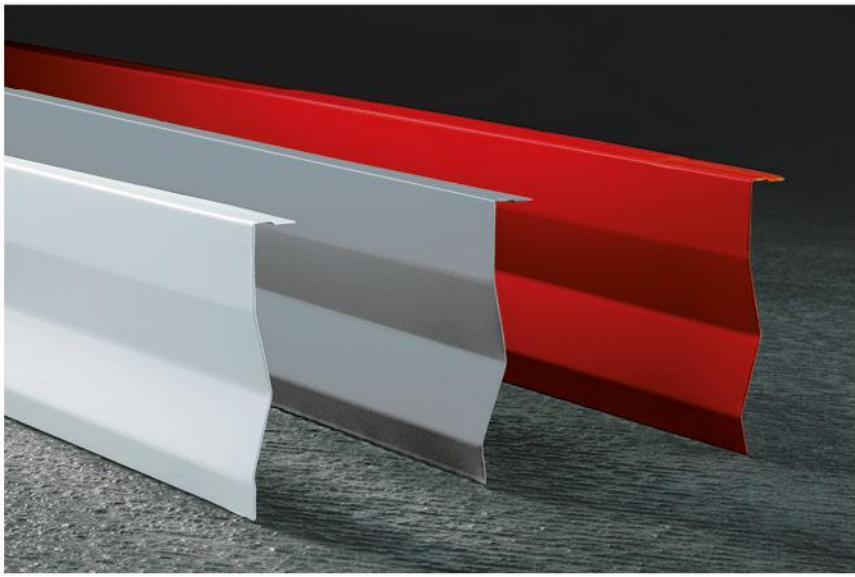

ALUMINUM 7-SHAPE BAFFLED CEILING

- By one-way installation of the ceiling, creating a screen vision. With the bright and elegant lines, 7-shaped baffled ceiling can produce the curtain effect if it choose appropriate height and visual angle. Moreover, it is easy to maintain and the whole space is commodious and ventilated.
- Suitable for office buildings, offices, corridors, airports, railway stations, factories, hospitals, clubs, banks, shopping malls, exhibition halls and so on.

Instruction

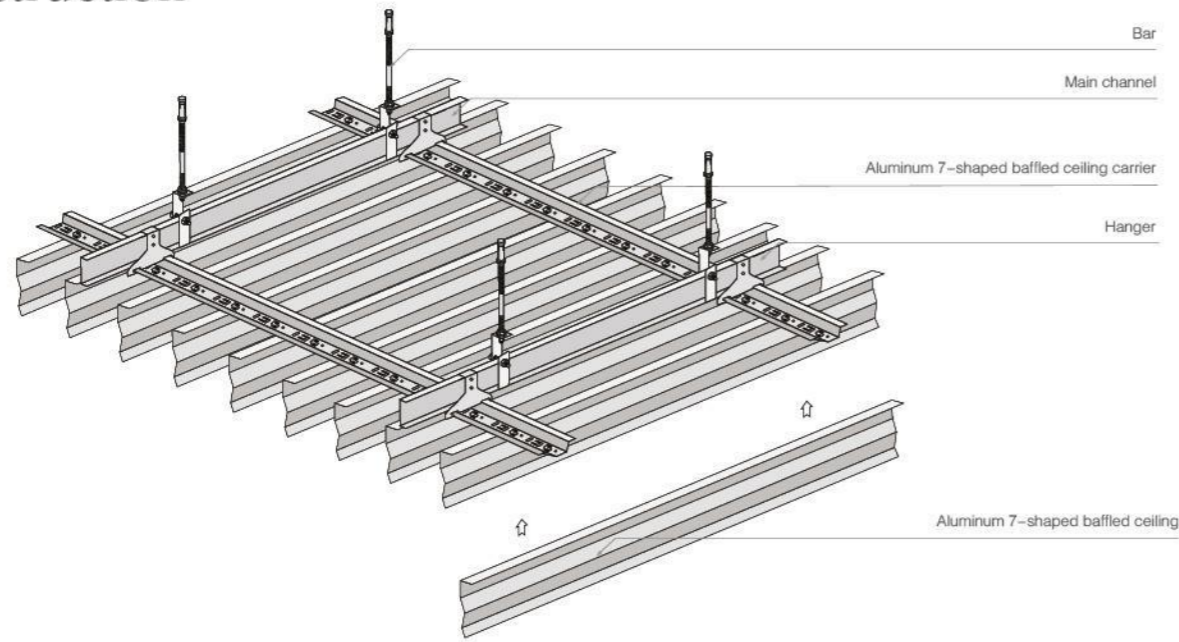

ALUMINUM OLECRANON BAFFLED CEILING

- Made of aluminum panel, electrostatic powder coating, olecranon baffled ceiling impresses people of the stable structure, moreover, it is fireproof, corrosion resistance, dampproof, sound-absorbing. Inserting straight to install, it is easy to assemble and unassemble, convenient for other equipments to maintain, such as electrical wire, water pipe, lighting, fire fighting device.
- Suitable for all kinds of channels of large public buildings, airports, exhibition halls, shopping centers, stations, tunnel corridors, etc.



Instruction

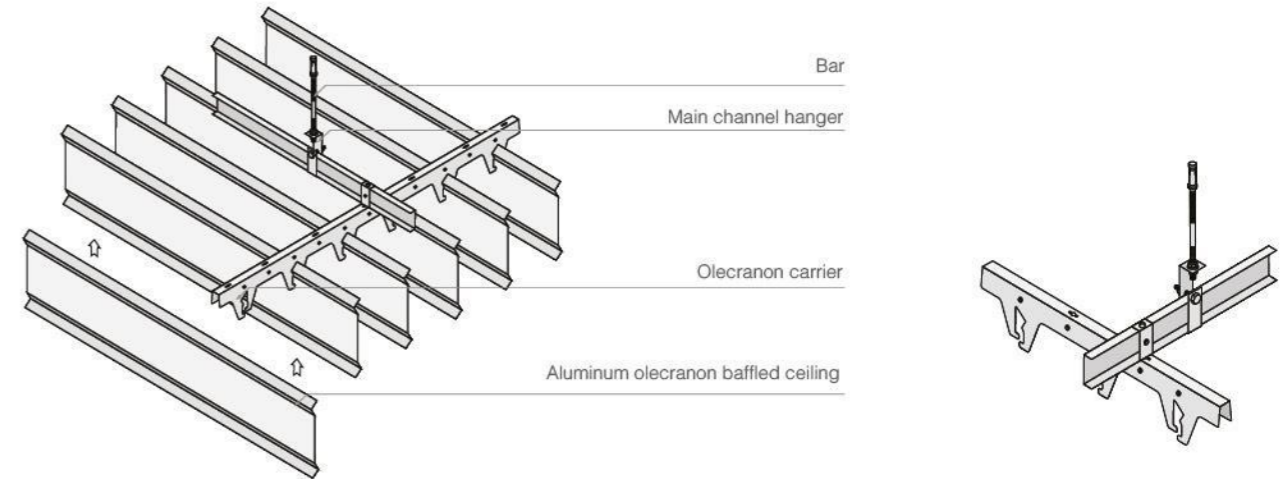

- The strip shape, smooth panel, close seam, clear line, C-shaped strip ceiling can form varieties of combination according to the width. The entire ceiling is neat, natural, compact arrangement, perspective space, modern style, also fireproof, corrosion resistance, dampproof, easy to assemble and disassemble. Besides, adding a piece of SoundTex on the backside of the punching panel is beneficial for Sound-absorbing.

- Suitable for shopping malls, hotels, office buildings, senior housing and so on.



C-SHAPED STRIP CEILING

Instruction

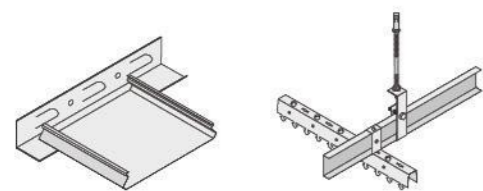
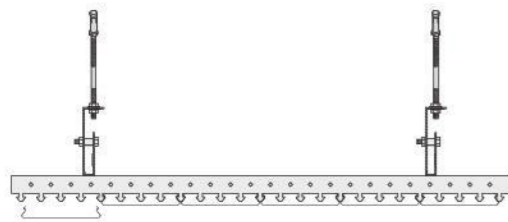

Width(W)	75mm	100mm	150mm	200mm	300mm
Thickness (D)	0.6-1.0mm				
Length (L)	customized				
Height(H)	15.5mm				

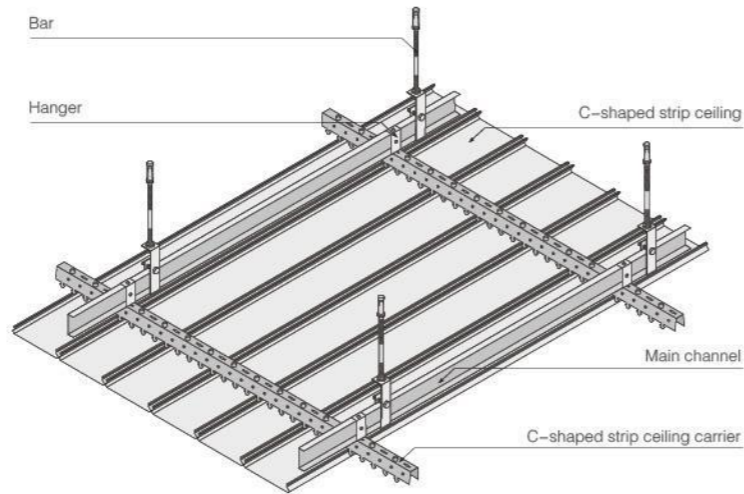

S-SHAPED STRIP CEILING

● With critic and scientific design, S-shaped strip ceiling is elegant and nature. On one hand, the ceiling relieves the drabness of the space, the fashion of streamlines fully spreads out, on the other hand, based on the special windproof design, the smooth and sealed panel reduces the dust, dirt and energy loss.

● Applicable to the corridor, swimming pools, gas stations, railway stations, airports and outdoor decorations.

	Straight angle	Beveled angle
Width(W)	300mm	300mm
Thickness(D)	0.8-1.0mm	0.8-1.0mm
Height(H)	28mm 30mm	30mm
Length (L)	customized	customized

Standard thickness: 0.8mm

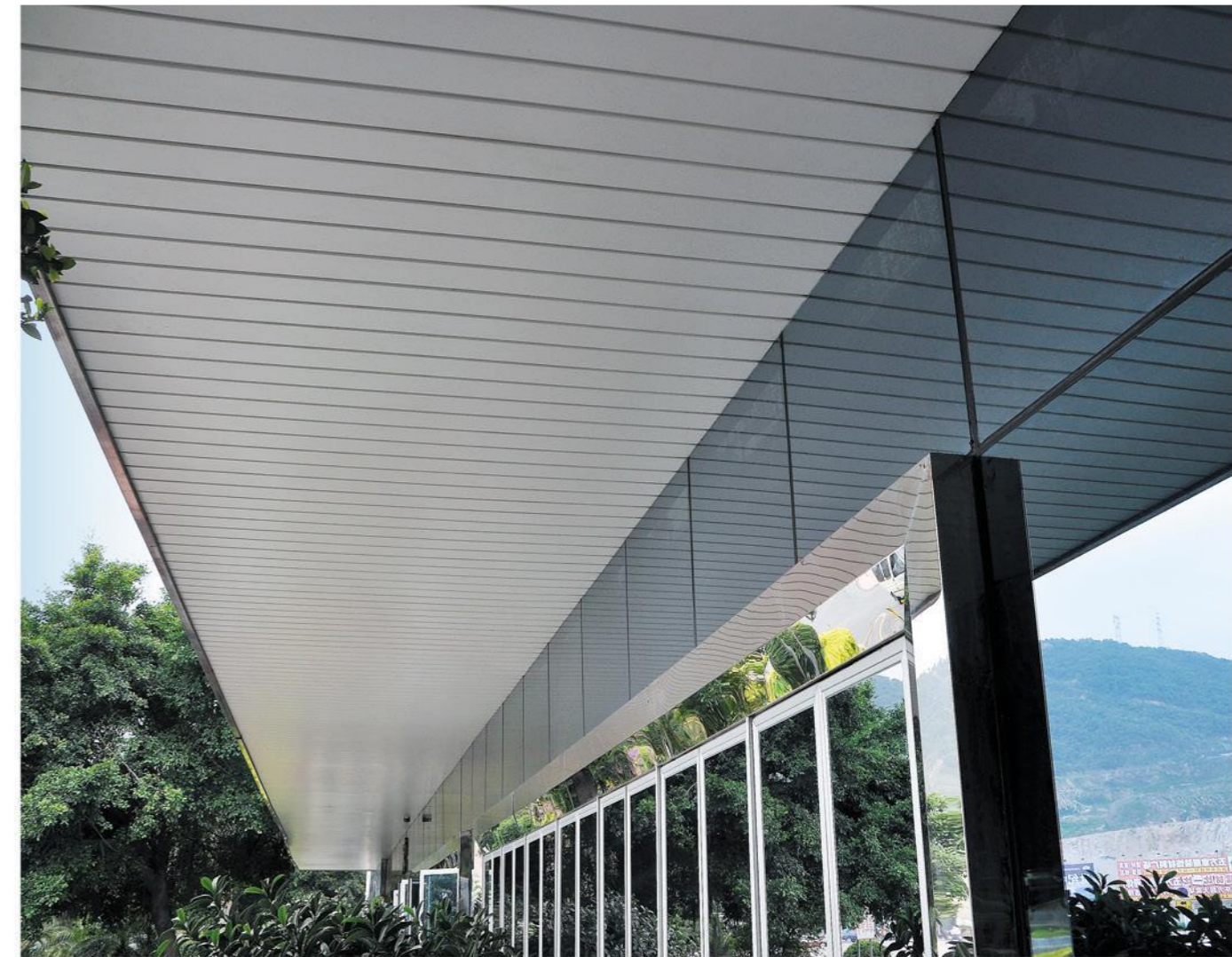

Instruction

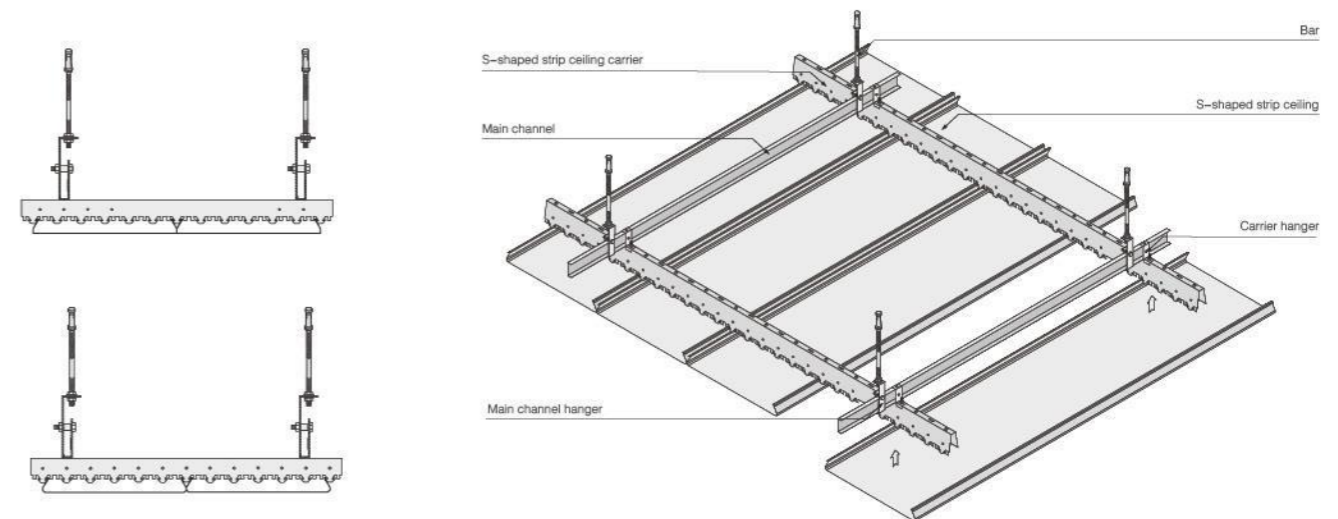

G-SHAPED STRIP CEILING

- Mainly made of high quality aluminum material, critically processed, G-shaped strip ceiling is different from traditional ceiling which offer rich colors to select. The open suspended ceiling build a elegant colorful space.
- Suitable for shopping malls, hotels, offices, entertainment facilities and so on.



Instruction

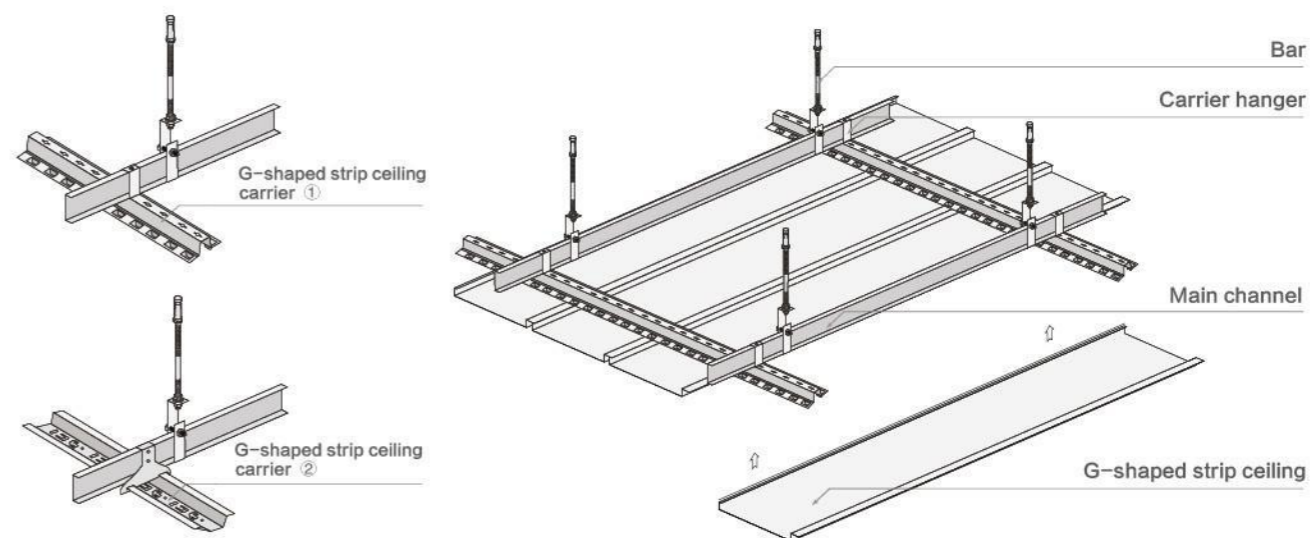

Width (W)	100mm	150mm	200mm	300mm
Thickness(D)	0.5-1.0mm			
Height(H)	11.5mm	15mm		
Length(L)	customized			

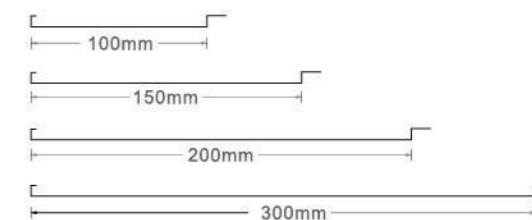

SOUND ABSORPTION SYSTEM

- Metal acoustic ceilings are artificial functional acoustic solutions. Noise is absorbed when the sounds are directed to specific zones, thus, the characteristics of the metal panel to influence the acoustic ability and feature in an indoors pace, in order to meet any specific expectations.
- For sound absorption, the propagation of sounds is absorbed by converting sound energy into thermal energy. Materials with sound-absorbing properties are called sound-absorbing materials. Be shown in Fig.1
- In practice, perforated ceiling made of metal, wood, plastic or gypsum and provided with a porous sound-absorbing materia 1 (thickness is 40mm) on the back are used for absorption of air-borne noises. Be shown in Fig.2

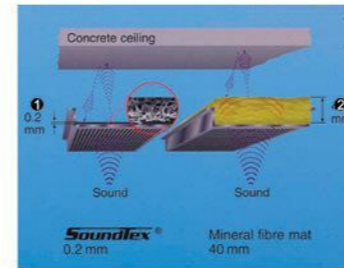

The transformation process of sound, which is on sound-absorbing materials.

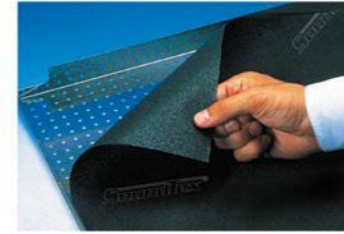

SoundTex sound-absorbing nonwovens can be mounted without difficulty into ceiling systems.

● Sound-absorbing Nonwovens

SoundTex sound-absorbing nonwovens is a sound dissipation and can be achieved by means of very thin absorbers presenting an appropriate sound impedance. A porous sound-absorbing material is our acoustic nonwoven SoundTex. On porous sound-absorbing materials, sound energy is mainly converted into thermal energy by viscous friction between the oscillating particles of the sound-propagating medium (air) and the structure of the porous material.

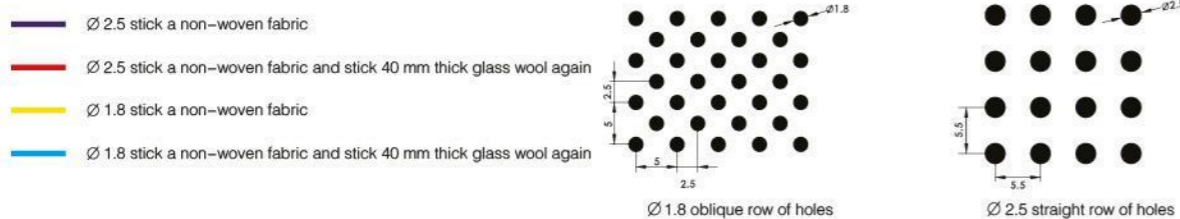
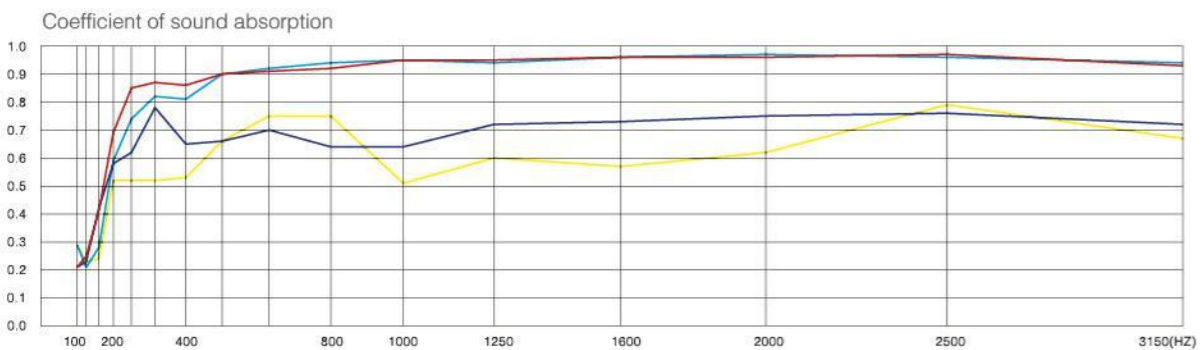
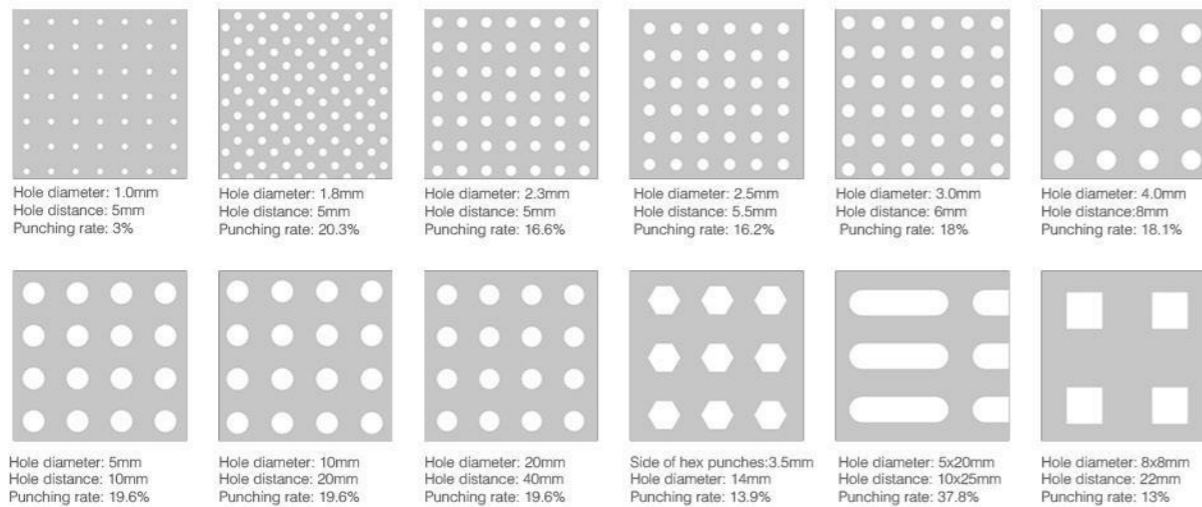

ACCESSORIES

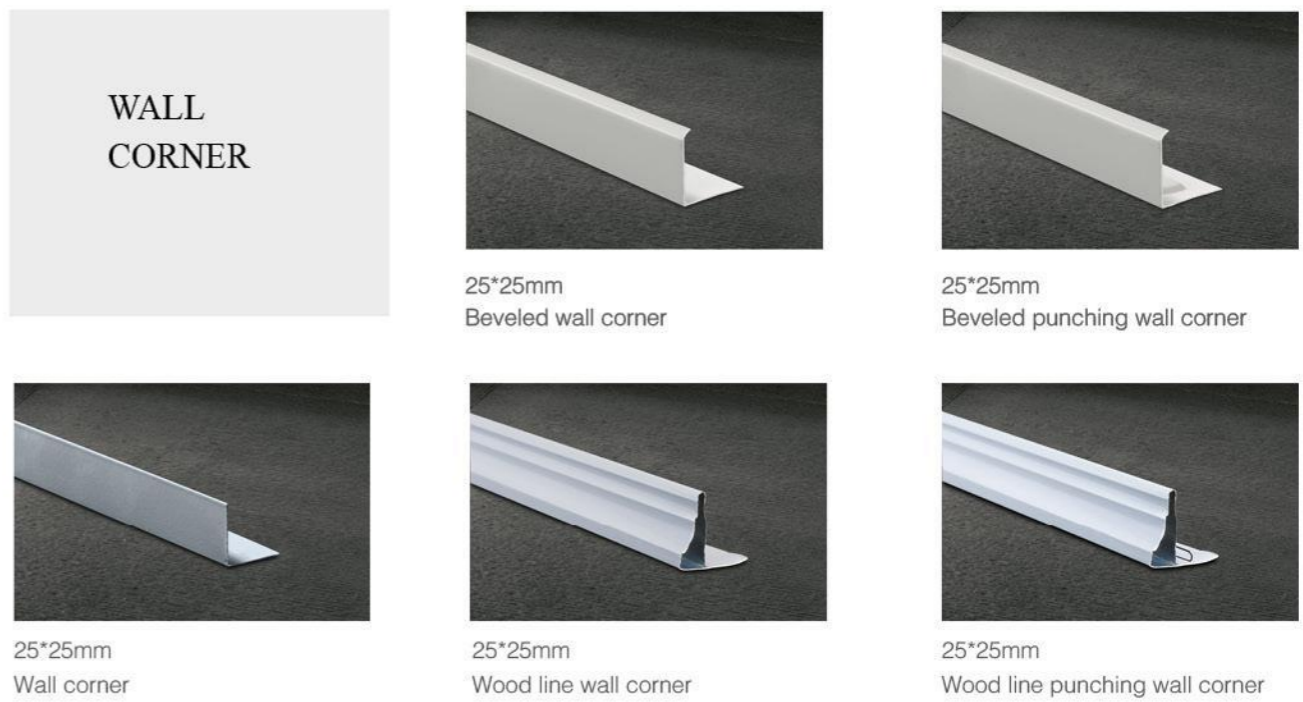
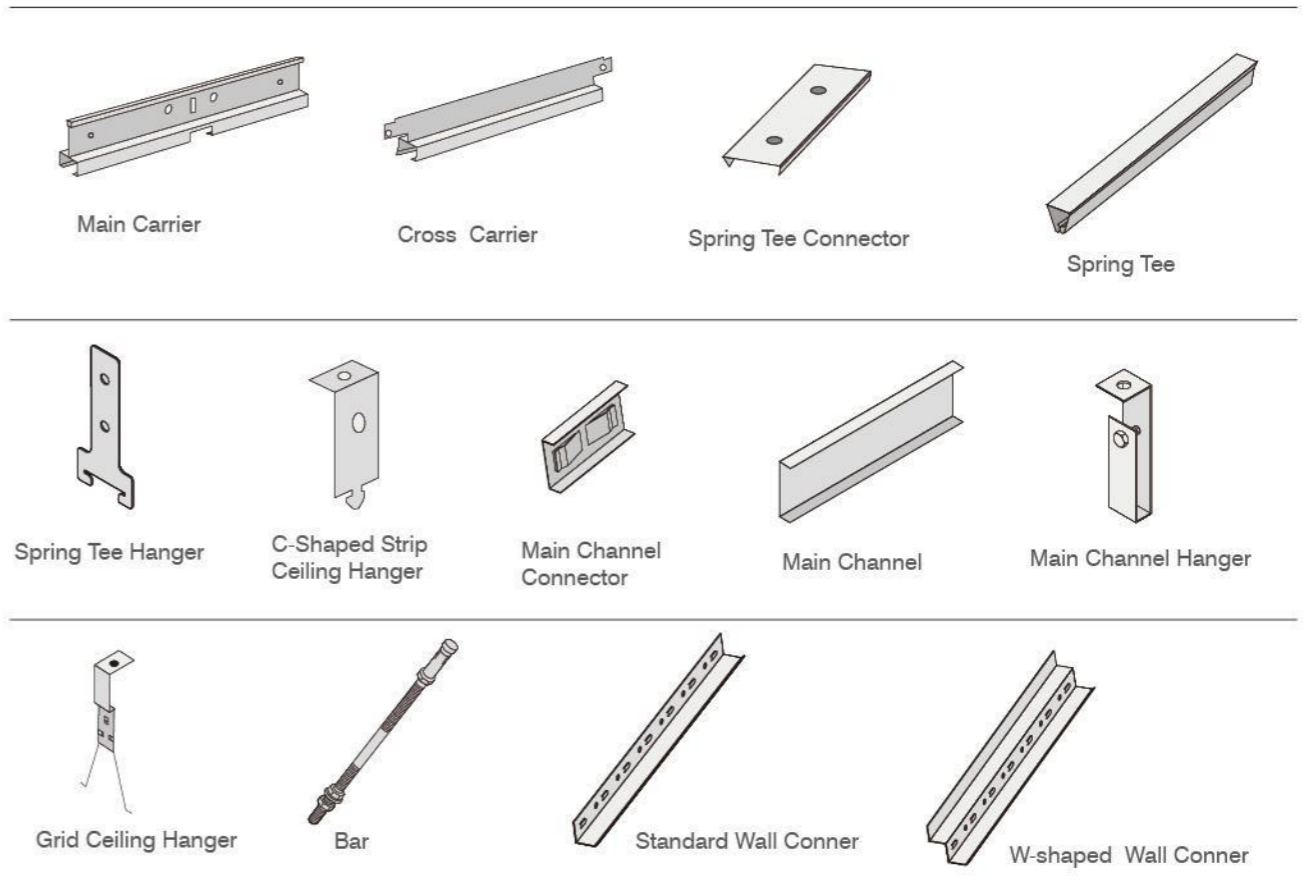

ALLUMINUM CEILING PATTERNS

Drawing of Punching Hole

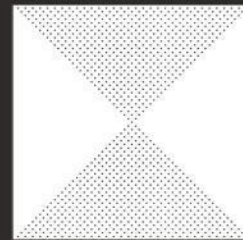
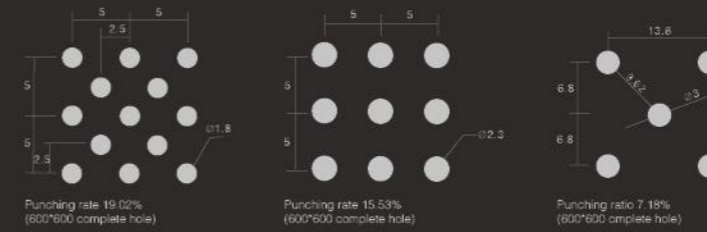

Description: \varnothing 3 diagonal aluminum square plate
Code:YC6001

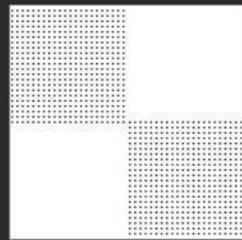

Description: \varnothing 3 quadrant diagonal punching aluminum square plate
Code:YC6002

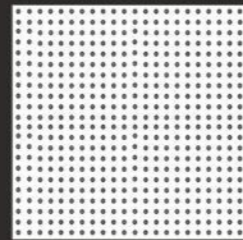

Description: \varnothing 3 full-punching aluminum square plate
Code:YC6003



Description: flat aluminum square plate
Code:YC6004

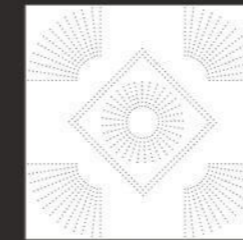

Description: \varnothing 3 daisy punching aluminum square plate C
Code:YC6041

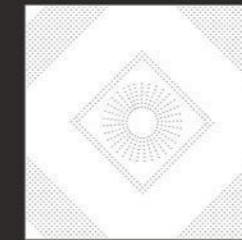

Description: \varnothing 3 daisy punching aluminum square plate D
Code:YC6042

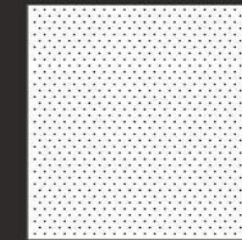

Description: \varnothing 1.8 full-punching aluminum square plate
Code:YC6043

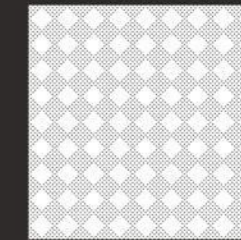

Description: \varnothing 1.8 big-check punching aluminum square plate
Code:YC6044

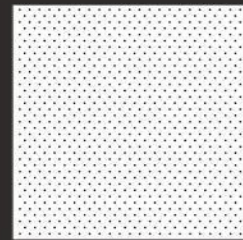

Description: \varnothing 2.2 full-punching aluminum square plate
Code:YC6005

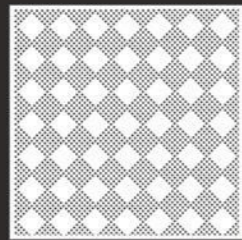

Description: \varnothing 3 49-grid match punching aluminum square plate
Code:YC6006

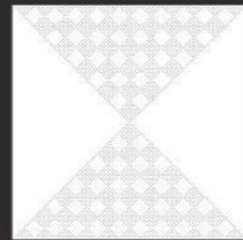

Description: \varnothing 3 diagonal match punching aluminum square plate
Code:YC6007

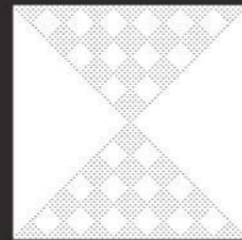

Description: \varnothing 3 diagonal match punching aluminum square plate
Code:YC6008

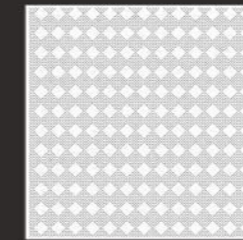

Description: \varnothing 1.8 medium-check punching aluminum square plate
Code:YC6045



Description: \varnothing 1.8 punching 25-grid aluminum square plate
Code:YC6046

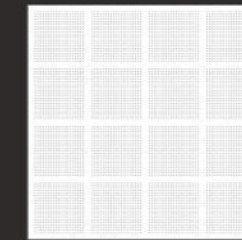

Description: \varnothing 1.8 punching 16-grid aluminum square plate
Code:YC6047

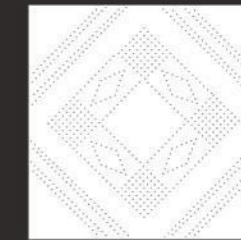

Description: \varnothing 3 punching match aluminum square plate
Code:YC6051



Description: \varnothing 3 prism side punching aluminum square plate
Code:YC6010

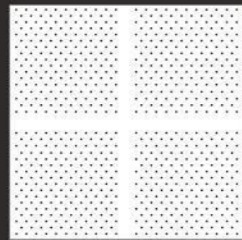

Description: \varnothing 3 quadrant four-corner punching aluminum square plate
Code:YC6012

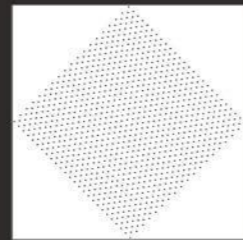

Description: \varnothing 3 prism punching match aluminum square plate
Code:YC6014



Description: #-shape aluminum square plate
Code:YC6018

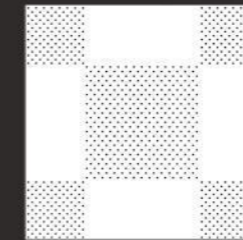

Description: \varnothing 3 punching match aluminum square plate
Code:YC6052



No.1 cloud



No.2 cloud



No.3 cloud

The actual picture of blue sky and white cloud, the above pictures are available for 600x600 and 300x300

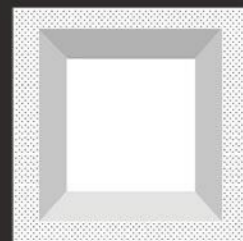

Description: \varnothing 3#-shape four-side punching aluminum square plate
Code:YC6019

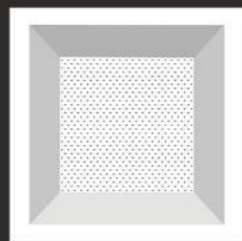

Description: \varnothing 3#-shape middle punching aluminum square plate
Code:YC6020

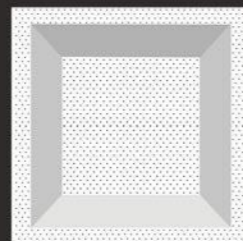

Description: \varnothing 3#-shape punching aluminum square plate
Code:YC6021

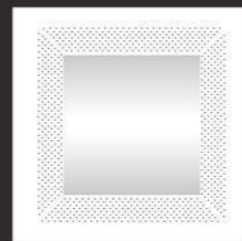

Description: \varnothing 3#-shape hypotenuse punching aluminum square plate
Code:YC6022

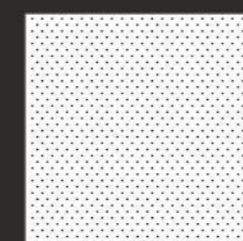

Description: \varnothing 3 full-punching aluminum square plate
Code:YC3002



Description: flat aluminum square plate
Code:YC3004

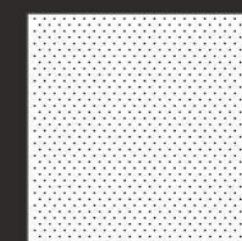

Description: \varnothing 1.8 full-punching aluminum square plate
Code:YC3005

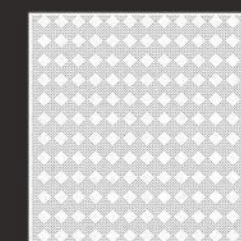

Description: \varnothing 1.8 medium-check punching aluminum square plate
Code:YC3006

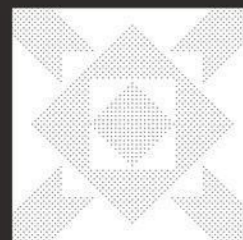

Description: \varnothing 3 four-corner-flower punching aluminum square plate
Code:YC6033

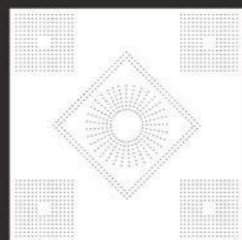

Description: \varnothing 3 punching match aluminum square plate
Code:YC6036

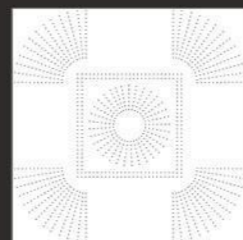

Description: \varnothing 3 daisy punching aluminum square plate A
Code:YC6039

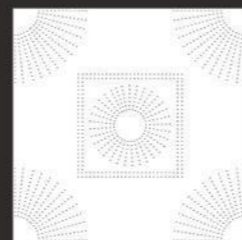

Description: \varnothing 3 daisy punching aluminum square plate B
Code:YC6040

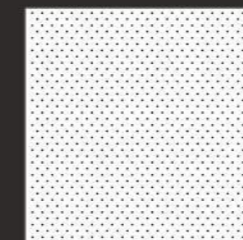

Description: \varnothing 1.8 small-check punching aluminum square plate
Code:YC3007



Description: round aluminum square plate
Code:YC3009

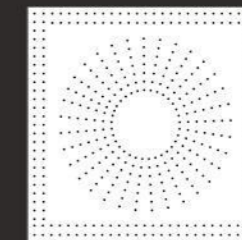

Description: \varnothing 3 daisy punching aluminum square plate
Code:YC3010

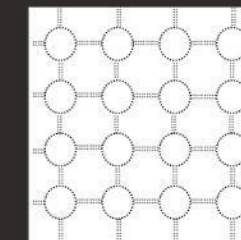

Description: \varnothing 3 small round aluminum square plate
Code:YC3011

PRE-PAINTED ALUMINUM CEILING



YC-1XX-001

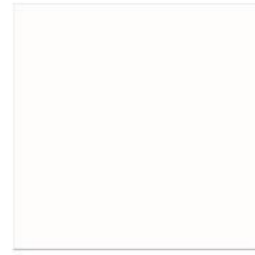

YC-1XX-002



YC-1XX-003



YC-1XX-004



YC-1XX-005



YC-1XX-007

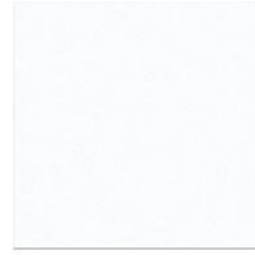

YC-1XX-008



YC-1XX-009



YC-1XY-006

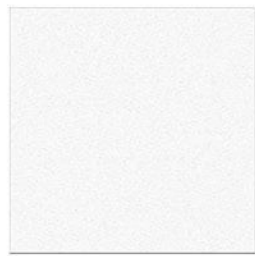

YC-2XX-001



YC-2XX-005



YC-2XX-006



YC-2XX-007

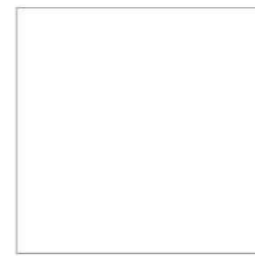

YC-2XY-002



YC-2XY-003



YC-2XY-004



YC-5XY-001



YC-5XY-002



YC-5XY-003



YC-5XY-004



YC-5XY-005



YC-5XY-006



YC-5XY-007



YC-5XY-008



YC-5XY-009



YC-5XY-010



YC-5XY-011



YC-5XY-012



YC-5XY-013



YC-5XY-014



YC-5XY-015



YC-5XY-016



YC-5XY-017



YC-5XY-018

BRUSHED CEILING SERIES

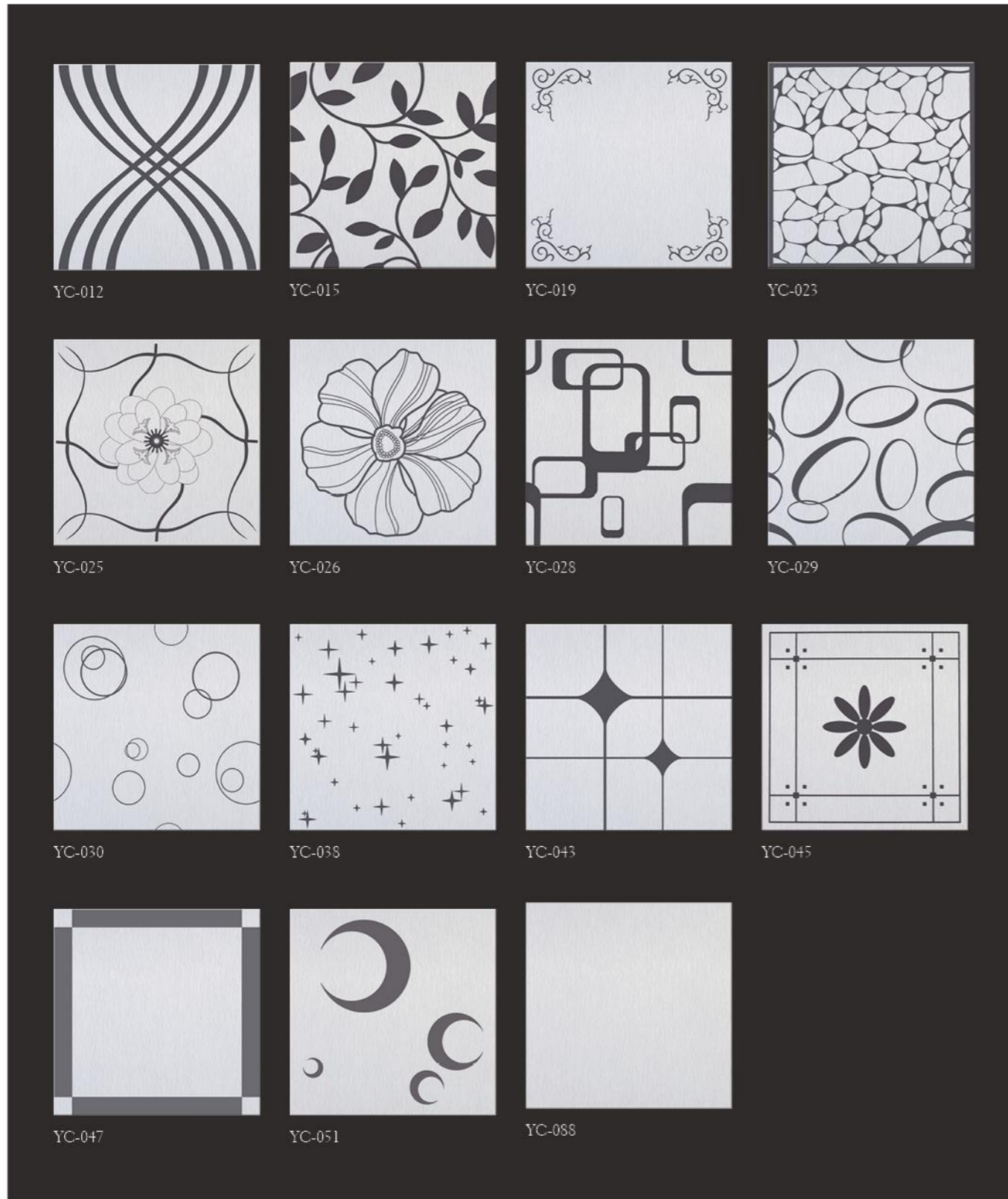

PROJECT CASE



PROJECT CASE



PROJECT LIST

Beijing Xidan Saite Shopping Center	Qingdao Ocean University	Guangxi Telecom Bureau
Beijing Haidian Theater	Beijing Fengtai Hotel	Changzhou First People's Hospital
Beijing Xicheng District people's Procuratorate	Beijing Yuquan building	Beijing Fudun Business Center
Wangfujing Foreign Languages Bookstore	The Beijing Aight One Middle School	Beijing Zhongshan Park
State Information Center	Police Headquarters	Zhongguancun Electronic Trade Hub
University of Witwatersrand in Shanghai City	Shanghai Pudong International Airport	Hohhot Government Office In Beijing
Shanghai Gymnasium	Shanghai Long Distance Bus Station	Shanghai Hongqiao International Airport
Nanjing Golden Eagle International Shopping Center	Nanjing Sheraton Le Grand Large Hotel	ShangHai Railway Station
Shenyang Liaoshen Campaign Memorial	Nanjing Normal University	Nanjing Hilton Hotel
Ji'nan Sanjian company Experimental Middle School	Henan TV Tower	Nanjing Jianye District People's Government Building
The Central Hospital of Ji'nan City	Jinan Yaoqiang Airport	Shaze City Nanhua Plaza
The Oil Field Administration of Tengli	Ji'nan Ouya Furniture City	Ji'nan City Judge Training School
Industry and Commerce Administration of Shandong Province	Shandong Normal University	Jining People's Hospital
Cigarette Factory of Shandong General Group	Shandong Hui Mountain Post Office	Shandong Railway Bureau
Yucheng City Eastern Mansion	Shandong Construction Engineering Group	Shandong Real Estate Development Company
Xuzhou Gulou District Court	The No. 1 Middle School of Yucheng City	Shandong Hengxin Development Ltd. Longkou Key Project
Xuzhou Ancient Architecture Museum	Xuzhou Power Plant	Xuzhou City Third Middle School Teaching Building
China University of Mining and Technology	The Gym of No. 1 middle school of Xuzhou	The School of Engineering of Xuzhou Normal University
Zhengzhou City Tax Building	Quanshan District Court	Xuzhou The Chinese People's Liberation Army of 73061
Zhengzhou City Library	Zhengzhou Silver City Based Business	Troops and Equipment Department
Jiahua Hotel of Kunming City	Kunming Airport	Jiangsu Huaining Finance Bureau
Zhuhai Yangtze River Industrial Garden	Zhuhai South Bay Crescent	Kunming City Tianheng Hotel
Nanchang Tobacco Building	Jiangxi Province Aight Two Aight Hotel	Sichuan China Mobile Ltd.
Pinghu People Hospital of Zhejiang City	Guiyang Department Store	The First Affiliated Hospital of Jiangxi Province
Ningbo Bus Station	Hangzhou Ling'an Foreign Trade Company	Guiyang Dongfeng Large Building
Xiamen Pacific Airports	Ningbo Qinzhou Bus Station	Ningbo State Security Bureau
Xiamen Accountancy Academy	Fujian Refining and Ethylene Analysis Experiment Building	Xiamen University
Quanzhou International Trade Building or Cetra Building	Jimei Xiamen Institute of Technology	Xiamen Golden Bay Garden
Changzhou Cheonan Digital City	Jinjiang Gas Power Plant	Changzhou Talent Market
Changzhou Power Supply Bureau	Changzhou Tianning Court	Changzhou Hutang Bank of China
Hebei Xingtai Longquan Mountain Villa Resort	Changzhou Guanghua Bridge Construction Bank Headquarters	Hebei Jinniu Group: Dongpang Coal Mine, Gequan Coal Mine
Anhui University	Hefei SASAC	Anhui Grand Theatre
Artillery Academy of Hefei	Hefei College of business	University of Science and Technology of China
Hefei Passenger Terminal	The Second Miners Hospital of Huainan	Kinsey Train Station
The Computer City of Hefei City Golden Plaza	Hefei Traffic Police Center	Fuyang Train Station
Hunan University	Hehuai Fugaojian Company Service Stati	Changsha University of Science and Technology
Changsha Power Supply Bureau	Changsha Post and Telecommunication Bureaus.	Hunan Broadcasting and Television Center
International University of Science and Technology	The Construction Bank of Changsha outlets	Changsha City Agricultural Bank Outlets
Good Hundred Years Home Furnishing Plaza	Sany Heavy Industry	Zoomlion
The Second and Third Affiliated Hospital of Changsha	Xiangxiang Middle School	Hunan Province Luqiao Charge
Hohhot Taxation Bureau Office Building	Nanjing Sanjiang University	Hohhot Electric Power Mansion
Changsha City Agricultural Bank Outlets	Hohhot Xinhua Bookstore	The Shanghai subway station (part)
Shanghai Nanjiang University	Hangzhou Theater	Shanghai Jiao Tong University
Shanghai Normal University	Shanghai international car city (part)	Nanjing Agricultural University
Southeast University in Nanjing	Shanghai pudong zhangjiang high tech park	Nanjing Jinsheng International Home Furnishing Plaza
International University of Science and Technology	Nanjing Central Emporium	Hefei Department Store in Fuyang City
WuXi Railway Station	Anhui Province Economic and Trade Commission Business Building	Wuxi Ouxiang Supermarket
Guiyang Department Store	Wuxi District People's Court	Hangzhou Taxation Building
Hangzhou Yongjin Plaza	Hangzhou University of Posts and Telecommunications	Laiyang Agricultural College in Shandong
The Post Office of Guangxi Nanning Area	Zhejiang Yuyao Clothing Market	Guangxi Yining Bureau
		The head office of the Agricultural Bank of Changzhou