

生产 production 装配 assembly 仓库 warehouse 出货 Load shipment



Contents 目录

P1-10

护栏 Plastic Fence



P11-22

水马 Water Barrier



P23-26

路锥 Traffic cone



P27-30

诱导柱 Guide post



P31-32

警示板 Flexible guide pannel



P33-34

安全踏板 Trench Cover



P35-40

路障警示灯 Warning lamps



P41

全塑胶临时路牌 Plastic Cone sign



P42-46

减速带 Speed humps



P47

广角镜 Mirror



P48

伸缩杆



P49-50

道钉 Road Studs



P51-52

塑料安全网 Plastic Fence / 警示带



P53-54

防眩板/安全盖 Safety Cover



P55-56

安全背心 Safety Vests
安全头盔 Safety Helmets



P57

指挥棒 Reflective baton



P58

三角警示牌 Warning triangle



P59

反光膜 Reflective Sheeting



P60-61

吹塑划艇 Blow Rowboat
浮桶 floating barrels



P62

井盖 Manhole Cover



P63-64

塑料托盘 Plastic pallet



○ 护栏 Plastic Fence

这种护栏是吹塑工艺,包括护栏和两个可以旋转的脚,它可以几个连成一排把道路隔开,也可以连成一个圈把工作区围住.

材料:塑料PE、橡胶、反光膜

高度: 1000mm

长度: 2000mm

厚度: 55mm

重量: 13kg ± 0.5kg

颜色可根据客户要求定做,连接方便

This barrier is blow-moulded, including one barrier and two rotatable legs

It can be joint to a line to direct the way or divide the road to two parts Also, it could be circled for repair work.

Material: Plastic PE, rubber, reflective sheeting

Height: 1000mm

Length: 2000mm

Thickness: 55mm

Weight: 13kg ± 0.5kg

We can produce as your special request

Linking facility allowing system can be easily joined.



安装前
--Before installation



安装后
--After installation



型号(model):LZL-HL-01



型号(model):LZL-HL-02



型号(model):LZL-HL-03



型号(model):LZL-HL-04

连接方式一
Connection mode1



连接方式二
Connection mode2



型号(model):LZL-HL-05



型号(model):LZL-HL-06



型号(model):LZL-HL-07



型号(model):LZL-HL-08

型号(model):LZL-HL-09

有伸缩系统, 能从240mm延伸到2600mm
 宽度(全部打开): 2600mm
 宽度(合拢): 240mm
 高度: 960mm
 重量: 2.2kg±0.2kg
 材料: HDPE material:HDPE
 颜色可根据客户要求定做
 The plastic extensible barrier redirects traffic in unsafe and risky conditions.
 It extends from 240mm to 2600mm with a flexible bending system.
 Width(full open):2600mm
 Width(full closed):240mm
 Height:960mm
 Weight:2.2kg±0.2kg
 We can produce as your special request



型号(model):LZL-HL-10

有伸缩系统, 能从130mm延伸到2300mm
 宽度(全部打开): 2300mm
 宽度(合拢): 130mm
 高度: 1070mm
 重量: 6.2kg±0.3kg
 材料: HDPE material:HDPE
 颜色可根据客户要求定做
 The plastic extensible barrier redirects traffic in unsafe and risky conditions.
 It extends from 130mm to 2500mm with a flexible bending system.
 Width(full open):2500mm
 Width(full closed):130mm
 Height:1070mm
 Weight:6.2kg±0.3kg
 We can produce as your special request



型号(model):LZL-HL-11

Material: glass fiber reinforced plastic
 材料: 玻璃钢
 有伸缩系统, 能从130mm延伸到2300mm
 宽度(全部打开): 1000mm-3000mm
 宽度(合拢): 220mm
 高度: 1200mm
 重量: 6kg
 材料: HDPE material:HDPE
 颜色可根据客户要求定做
 The plastic extensible barrier redirects traffic in unsafe and risky conditions.
 It extends from 130mm to 2300mm with a flexible bending system.
 Width(full open):1000mm-3000mm
 Width(full closed):220mm
 Height:1200mm
 Weight:6kg
 We can produce as your special request

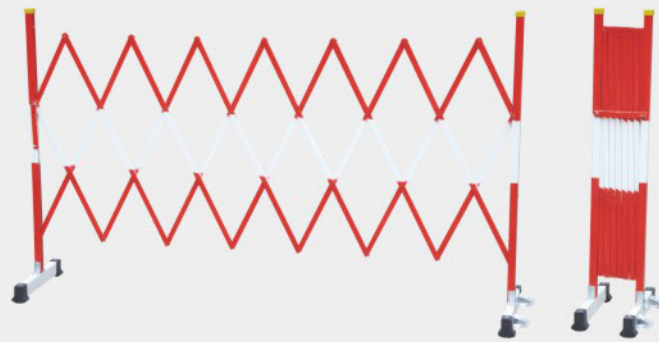

护栏 Plastic Fence

型号(model):LZL-HL-12

这种护栏是吹塑工艺,包括护栏和四个可以旋转的脚,它可以几个连成一排把道路隔开,也可以连成一个圈把工作区围住。
 材料:塑料PE、反光膜
 高度: 1000mm
 长度: 1250mm / 1500mm
 厚度: 30mm
 重量: 20kg±1kg / 24kg±1kg
 颜色可根据客户要求定做
 连接方便

This barrier is blow-moulded, including one barrier and two rotatable legs. It can be joint to a line to direct the way or divide the road to two parts. Also, it could be circled for repair work.
 Material: Plastic PE reflective sheeting
 Height:1000mm
 Length:1250mm/1500mm
 Thickness:30mm
 Weight:20kg±1kg / 24kg±1kg
 We can produce as your special request
 Linking facility allowing system can be easily joined.



型号(model):LZL-HL-13

该产品通过德国塑料护栏TL标准测试
 层压式堆叠设计, 节约空间, 方便运输
 能根据客人不同需要选定颜色及在产品上刻上客人的商标
 整体设计, 坚固实用
 可替换的灯座连接器, 能为护栏配上路障灯
 路障灯能根据不同的需要安装在护栏上
 重量虽轻但产品稳固
 该产品有防晒配方
 用于道路分离及施工现场保护
 独特的漏风设计, 能防御强风吹袭
 独特360度旋转护栏连接器, 能连接不同的角度旋转的护栏

Tested to comply with the TL barrier panel requirements incl. Of protedting frames.
 *Designed for compact stacking to provide low transport costs
 *Choice of colours and customer's logo imprint on request
 *Sturdy laminated edge
 *Replaceable adapter for lamps(industrial property rights applied for)
 *Lamps can be fixed at various angles with no danger of skewing
 *More stability with less weight
 *UV stability
 *Can be used as lane partitions on road or substitute barriers
 *Greater wind resistance due to special profile
 *Speical designed connector with 360 swivel to link up any position

| | |
|-----------|----------|
| length | 2200mm |
| height | 1060mm |
| thickness | 52mm |
| weight | 70kg±2kg |

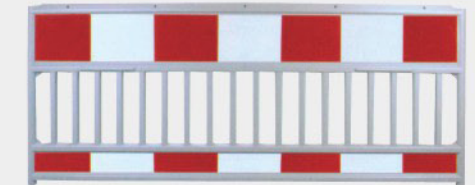

护栏 Plastic Fence

这种护栏是吹塑工艺,包括护栏和两个可以旋转的脚,它可以几个连成一排把道路隔开,也可以连成一个圈把工作区围住。

材料:塑料PE、反光膜

颜色可根据客户要求定做,连接方便

This barrier is blow-moulded, including one barrier and two rotatable legs. It can be joint to a line to direct the way or divide the road to two parts. Also, it could be circled for repair work.

Material: Plastic PE reflective sheeting

We can produce as your special request

Linking facility allowing system can be easily joined.



型号(model):LZL-HL-14

高度: 1000mm Height:1000mm
长度: 1500mm Length:1500mm
厚度: 50mm Thickness:50mm
重量: 5kg±0.5kg Weight:5kg±0.5kg



型号(model):LZL-HL-15

高度: 1000mm Height:1000mm
长度: 2000mm Length:2000mm
厚度: 50mm Thickness:50mm
重量: 6.5kg±0.5kg Weight:6.5kg±0.5kg

型号(model):LZL-HL-16

危险环境下的交通场所,用于改造。
有伸缩系统,能从300mm延伸到3900mm
宽度(全部打开):3900mm
宽度(合拢):300mm
高度:1000mm
重量:15kg±0.5kg
颜色可根据客户要求定做

The plastic extensible barrier redirects traffic in unsafe and risky conditions.

It extends from 300mm to 3900mm with a flexible bending system.

Width(full open):3900mm

Width(full closed):300mm

Height:1000mm

Weight:16kg±0.5kg

We can produce as your special request



型号(model):LZL-HL-17

危险环境下的交通场所,用于改造。

宽度:500mm

高度:1000mm

重量:3kg±0.3kg

颜色可根据客户要求定做

The plastic extensible barrier redirects traffic in unsafe and risky conditions.

Width:500mm

Height:1000mm

Weight:3kg±0.3kg

We can produce as your special request



型号(model):LZL-HL-18

材料:塑料PE、橡胶、反光膜

高度:1000mm

长度:1500mm

厚度:30mm

重量:6kg±0.5kg

颜色可根据客户要求定做,连接方便

Material: Plastic PE

Height:1000mm

Length:1500mm

Thickness:30mm

Weight:6kg±0.5kg

We can produce as your special request

Linking facility allowing system can be easily joined.



型号(model):LZL-HL-19

材料:塑料PE、橡胶、反光膜

高度:1135mm

长度:2260mm

厚度:65mm

重量:15kg±0.5kg

颜色可根据客户要求定做,连接方便

Material: Plastic PE

Height:1135mm

Length:2260mm

Thickness:65mm

Weight:15kg±0.5kg

We can produce as your special request

Linking facility allowing system can be easily joined.



型号(model):LZL-HL-20

材料:塑料PE、反光膜

高度:2000mm

长度:1000mm

厚度:50mm

重量:12kg±0.5kg

Material: Plastic PE reflective sheeting

Height:2000mm

Length:1000mm

Thickness:50mm

Weight:12kg±0.5kg



型号(model):LZL-HL-21

材料:塑料PVC、橡胶、反光膜

高度:1000mm

长度:2000mm

厚度:50mm

重量:11.5kg±0.5kg

Material: Plastic PE

Height:1000mm

Length:2000mm

Thickness:55mm

Weight:11.5kg±0.5kg



型号(model):LZL-HL-22

材料:塑料PE、橡胶、反光膜

高度:1060mm

长度:2200mm

厚度:52mm

重量:70kg±2kg

Material: Plastic PE

Height:1060mm

Length:2200mm

Thickness:52mm

Weight:70kg±2kg



室内围栏 Indoor barrier

elevator fence

可适用于室内，展会，电梯维修，机械维护，车间，大型室外活动。

elevator maintenance

Interior fencing, elevator maintenance,

Light simple, can be any combination, any move.

Can be used in indoor, exhibition, mechanical maintenance, workshop, large outdoor activities.



型号(model):LZL-HB-01

| | |
|-----------|--------|
| 高度/Height | 1050mm |
| 宽度/Width | 650mm |
| 重量/weight | 6.5kg |



型号(model):LZL-HB-02

| | |
|-----------|-------|
| 高度/Height | 900mm |
| 宽度/Width | 430mm |
| 重量/weight | 5kg |

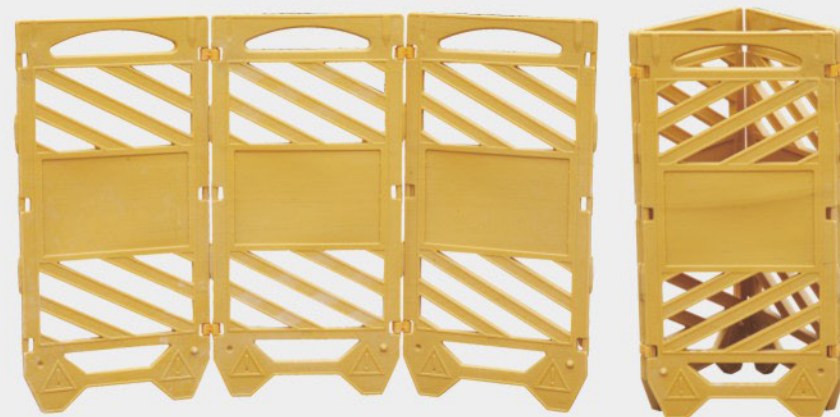

型号(model):LZL-HB-03

| | |
|-----------|--------|
| 高度/Height | 780mm |
| 宽度/Width | 1000mm |
| 重量/weight | 8kg |

型号(model):LZL-HB-04

| | |
|-----------|--------|
| 高度/Height | 1000mm |
| 宽度/Width | 500mm |
| 重量/weight | 6kg |



型号(model):LZL-HB-05

| | |
|-----------|--------|
| 高度/Height | 1000mm |
| 宽度/Width | 500mm |
| 重量/weight | 8kg |



◦ 儿童安全围栏 *Child safety fence*

Can be customized according to requirements.
可根据要求定制。



◦ 金属护栏 *Mental Fence*

型号(model):LZL-HL-22

| | |
|-----------|--------|
| length | 3000mm |
| height | 800mm |
| thickness | 50mm |



型号(model):LZL-HL-23

| | |
|-----------|--------|
| length | 3000mm |
| height | 1000mm |
| thickness | 50mm |



型号(model):LZL-HL-24

| | |
|-----------|--------|
| length | 3000mm |
| height | 1000mm |
| thickness | 50mm |



◦ 水马 Water Barrier

型号(model):LZL-5M-01

这种水马由抗UV紫外线稳定性好的塑料做成

材料:塑料PE

水马可以通过顶部的管口填充水或者沙子底部有便于排水的孔

底部的槽,便于叉车搬运

尾部的挂钩部分使整体容易地连接一起

Manufactured from UV stabilised HDPE

System can be water or sand filled via plug at top of unit

Lower plug in base for easy drainage

Slot at base for ease of sighting with forklift

integral end section for linking units together



| | |
|-----------------|-------------|
| Length:1400mm | 长度:1400mm |
| Height:900mm | 高度:900mm |
| Width:420mm | 宽度:420mm |
| Weight:12.5±1KG | 重量:12.5±1KG |
| Color:Red/White | 颜色:红色/白色 |

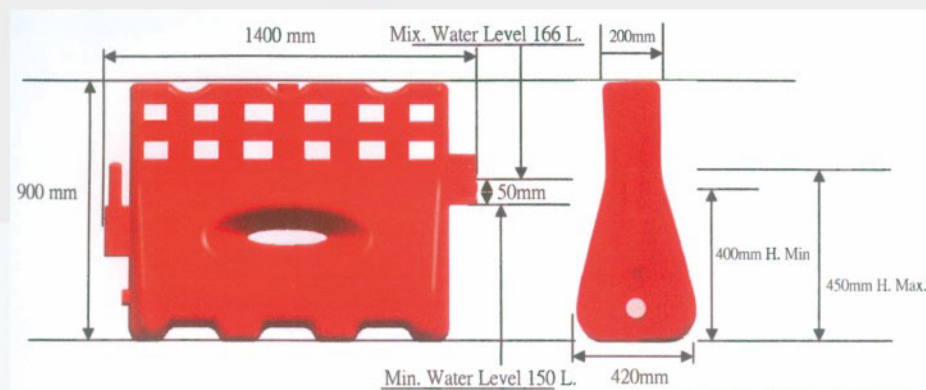

型号(model):LZL-5M-02

透明型临时隔音屏风

护栏屏障可以为行人专用区的使用

一个1.4米的水马固定到白色或红色的插棍,也进入另外一套位于相应的红色或白色的护栏.

利用水马之前的长隔柱,可以在水马上加装塑料屏风,从而更好地分隔车道与行人.

围栏和屏风固定在水马上,以增加水马整体的高度.这使得它更好地达到分隔行人和车道的目的.

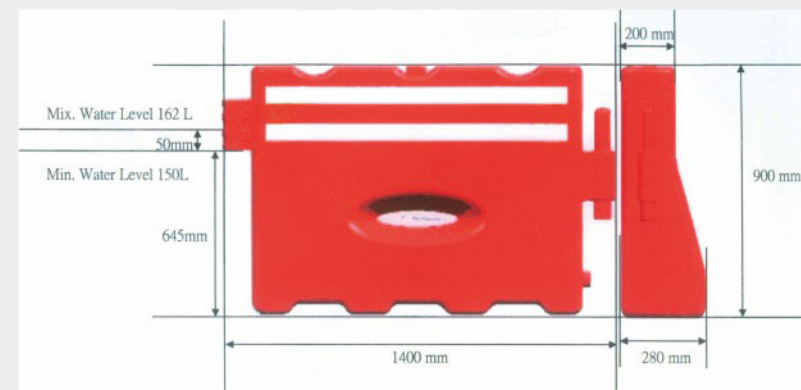

型号(model):LZL-5M-01-A



◦ 水马 Water Barrier

型号(model):LZL-5M-03

这种水马由抗UV紫外线稳定性好的塑料做成
 材料:塑料PE、反光膜
 长度: 1500mm
 高度: 1050mm
 上宽: 200mm
 下宽: 350mm
 重量:19±1千克
 水马可以通过顶部的管口填充水或者沙子底部有便于排水的孔底部的槽,便于叉车搬运尾部的挂钩部分使整体容易地连接一起

Manufactured from UV stabilised HDPE
 Material: Plastic PE reflective sheeting
 Length:1500mm
 Height: 1050mm
 Width top:200mm
 Width bottom:350mm
 Weight:19±1KGS
 System can be water or sand filled via plug at top of unit
 Lower plug inbase for easy drainage
 Slot at base for ease of sighting with forklift
 integral end section for linking units together



型号(model):LZL-5M-04

这种水马由抗UV紫外线稳定性好的塑料做成
 水马可以通过顶部的管口填充水或者沙子底部有便于排水的孔底部的槽,便于叉车搬运尾部的挂钩部分使整体容易地连接一起
 材料: 塑料PE、反光膜
 长度: 1500mm
 高度: 900mm
 上宽: 220mm
 下宽: 450mm
 重量:13±1千克

Manufactured from UV stabilised HDPE
 System can be water or sand filled via plug at top of unit
 Lower plug inbase for easy drainage
 Slot at base for ease of sighting with forklift
 integral end section for linking units together
 Material: Plastic PE reflective sheeting
 Length:1500mm
 Height: 900mm
 Width top:220mm
 Width bottom:450mm
 Weight:13±1KGS

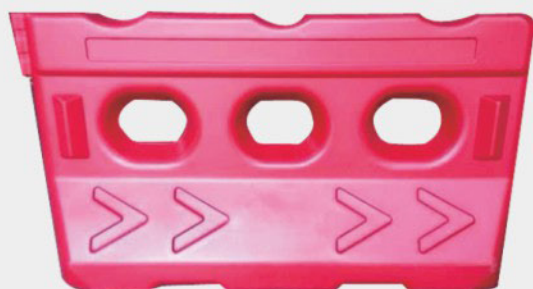
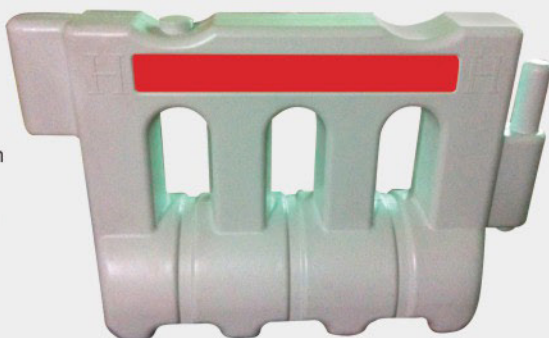

型号(model):LZL-5M-05

材料: 塑料PE
 Material: Plastic PE
 长度/Length: 1450mm
 高度/Height: 800mm
 上宽/Width top: 200mm
 下宽/Width bottom: 400mm
 重量/Weight:11kg±0.5kg



型号(model):LZL-5M-06

材料: 塑料PE、反光膜
 Material: Plastic PE
 长度/Length: 1500mm
 高度/Height: 1150mm
 重量/Weight: 12kg±0.5kg

◦ 水马 Water Barrier

型号(model):LZL-5M-07

这种水马由抗UV紫外线稳定性好的塑料做成
 材料:塑料PE、反光膜
 水马可以通过顶部的管口填充水或者沙子底部有便于排水的孔底部的槽,便于叉车搬运尾部的挂钩部分使整体容易地连接一起
 材料: 塑料PE、反光膜
 长度: 1300mm
 高度: 630mm
 上宽: 200mm
 下宽: 400mm
 重量:9±1千克

Manufactured from UV stabilised HDPE
 System can be water or sand filled via plug at top of unit
 Lower plug inbase for easy drainage
 Slot at base for ease of sighting with forklift
 integral end section for linking units together
 Material: Plastic PE reflective sheeting
 Length:1300mm
 Height: 630mm
 Width top:200mm
 Width bottom:400mm
 Weight:9±1KGS



型号(model):SM-07-01



型号(model):SM-07-02



型号(model):SM-07-03



型号(model):SM-07-05



型号(model):SM-07-04



型号(model):SM-07-06

◦水马 Water Barrier

型号(model):LZL-5M-08

材料: 塑料PE、反光膜 Material: Plastic PE
 长度: 1450mm Length:1450mm
 高度: 800mm Height: 800mm
 上宽: 220mm Width top:220mm
 下宽: 450mm Width bottom:450mm
 重量: 12kg±1kg Weight:12kg±1kg



型号(model):LZL-5M-09

材料: 塑料PE Material: Plastic PE
 长度: 1000mm Length:1000mm
 高度: 600mm Height: 600mm
 上宽: 100mm Width top:100mm
 下宽: 250mm Width bottom:250mm
 重量: 4.5kg±0.5kg Weight:4.5kg±0.5kg



型号(model):LZL-5M-10

材料: 塑料PE、反光膜 Material: Plastic PE
 长度: 560mm Length:560mm
 高度: 560mm Height: 560mm
 上宽: 150mm Width top:150mm
 下宽: 400mm Width bottom:400mm
 重量: 4kg±0.5kg Weight:4kg±0.5kg



型号(model):LZL-5M-11

材料: 塑料PE、反光膜 Material: Plastic PE
 长度: 500mm Length:500mm
 高度: 560mm Height: 600mm
 上宽: 170mm Width top:170mm
 下宽: 400mm Width bottom:400mm
 重量: 4kg±0.5kg Weight:4kg±0.5kg



◦水马 Water Barrier

型号(model):LZL-5M-12

材料: 塑料PE
 Material: Plastic PE
 宽度/Length: 1200mm
 高度/Height: 2000mm
 上宽/Width top:120mm
 下宽/Width bottom:350mm
 重量/Weight: 18kg±1kg



型号(model):LZL-5M-13

材料: 塑料PE
 Material: Plastic PE
 宽度/Length: 1200mm
 高度/Height: 1800mm
 上宽/Width top: 100mm
 下宽/Width bottom:350mm
 重量/Weight: 13kg±1kg



型号(model):LZL-5M-14

材料: 塑料PE、反光膜
 Material: Plastic PE
 宽度/Length: 1000mm
 高度/Height: 2000mm
 上宽/Width top:80mm
 下宽/Width bottom:400mm
 重量/Weight: 13kg±0.5kg



型号(model):LZL-5M-15

材料: 塑料PE
 Material: Plastic PE
 宽度/Length: 500mm
 高度/Height: 750mm
 重量/Weight: 3.8kg±0.5kg



型号(model):LZL-5M-16

材料: 塑料PE
 Material: Plastic PE
 长度/Length: 2000mm
 高度/Height: 780mm
 上宽/Width top: 200mm
 下宽/Width bottom:380mm
 重量/Weight: 15kg±1kg



型号(model):LZL-5M-17

材料: 塑料PE
 Material: Plastic PE
 长度/Length: 2000mm
 高度/Height: 800mm
 上宽/Width top: 145mm
 下宽/Width bottom:400mm
 重量/Weight: 15kg±0.5kg



◦ 水马 Water Barrier

型号(model):LZL-5M-18

可折叠水马是一种非常实用的水马，它们很容易地组合和连接起来，折叠水马可以被水或者沙子填充，层叠的设计非常有效地减少了运输成本。折叠水马由抗紫外线的稳定性好的塑料做成，常规的颜色是红色和白色，但是也可做按客人的要求颜色来生产。折叠水马可以被用在码头，机场，建筑区确保行人的指导和安全。

The Stackable water filled barrier is a substantial barrier that is easy to set up and link together. The barrier can be filled on site with water or sand for extra stability and is designed to stack very efficiently which enables transport cost to be reduced. The stackable water filled barrier are manufactured from UV stabilised polythene and are normally supplied in red or white but other colours are available on request. The stackable water filled barrier can be used at docks, airport and construction sites ensure pedestrian guidance and safety.

| | |
|-----------------|-----------|
| Length:1000mm | 长度:1000mm |
| Height:600mm | 高度:600mm |
| Width:500mm | 宽度:500mm |
| Weight:6.00kgs | 重量:6KG |
| Color:Red/White | 颜色:红色/白色 |



型号(model):LZL-5M-19

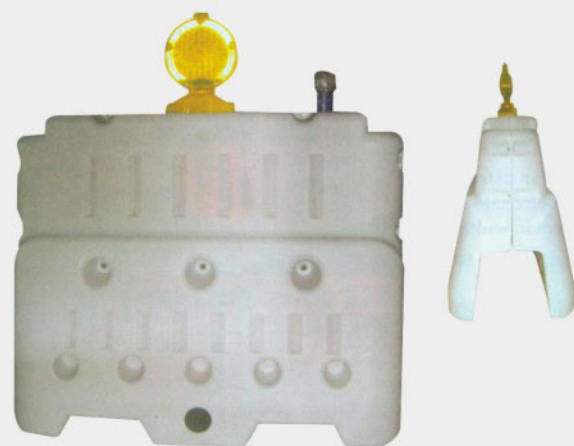

| | |
|-----------------|-----------|
| Length:1000mm | 长度:1000mm |
| Height:800mm | 高度:800mm |
| Width:500mm | 宽度:500mm |
| Weight:15.00kgs | 重量:15KG |
| Color:Red/White | 颜色:红色/白色 |

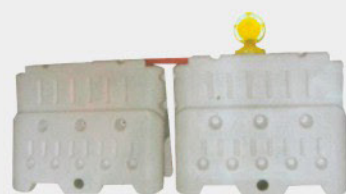

◦ 交通桶 Traffic Drum



型号(model):LZL-TD-01

Height:1350mm
Dia:500mm
Body:4.8kg
5pieces reflective tape



型号(model):LZL-TD-02

Height: 700mm
Dia:430mm
Body:3.5kg
6kg
4pieces reflective tape

LZL-TD-02A

Height : 1000MM
Base Dia: 460mm
Body:6kg
Base: 9 kg
4 pieces reflective tape .



型号(model):LZL-TD-03

Height: 1200mm
Base Dia:90mm
weight: 16kg
with 3 pieces reflective tape



型号(model):LZL-TD-04

Height: 800mm
Base Dia:500mm
weight: 3.5kg
with 2 pieces reflective tape



型号(model):LZL-TD-05

Top Width: 23cm
Bottom width: 74cm
Height: 110cm
Thickness: 5cm
Weight: App. 2.1Kg



型号(model):LZL-TD-06

Height: 1100mm
Top Width : 230mm
Bottom width:740mm
Thickness:50mm
weight: 2.6kg



型号(model):LZL-TD-07

Height: 1000MM
Length:1700mm
Thicknee: 50mm
weight: 4KG

◦ **滚塑 ROTATIONAL MOULDING**

可定制各种滚塑产品和滚塑模具。

can customize all kinds of Rotational products and Rotational mold!

型号(model):LZL-RM-01

材料: 塑料PE、反光膜

Plastic PE reflective sheeting

长度/Length: 1450mm

高度/Height: 800mm

上宽/Width top: 250mm

下宽/Width bottom: 486mm

重量/Weight: 15kg±0.5kg



型号(model):LZL-RM-02

材料: 塑料PE

Material: Plastic PE

长度/Length: 1700mm

高度/Height: 700mm

上宽/Width top: 200mm

下宽/Width bottom: 500mm

重量/Weight: 20kg±1kg



型号(model):LZL-RM-05

材料: 塑料PE

Material: Plastic PE

长度/Length: 1500mm

高度/Height: 900mm

上宽/Width top: 170mm

下宽/Width bottom: 450mm

重量/Weight: 18kg±1kg

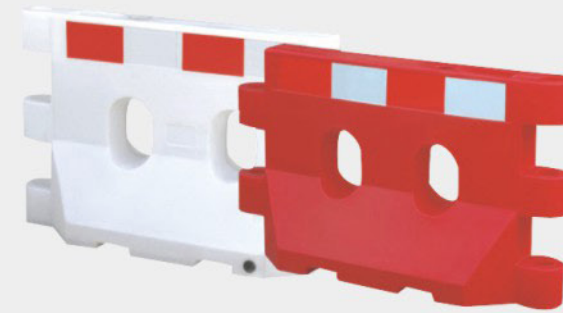

型号(model):LZL-RM-06

材料: 塑料PE

Material: Plastic PE

长度/Length: 1400mm

高度/Height: 900mm

上宽/Width top: 200mm

下宽/Width bottom: 400mm

重量/Weight: 13kg±1kg



型号(model):LZL-RM-03

材料: 塑料PE

Material: Plastic PE

长度/Length: 1500mm

高度/Height: 900mm

上宽/Width top: 150mm

下宽/Width bottom: 350mm

重量/Weight: 20kg±1kg

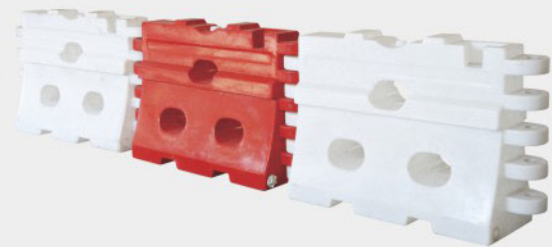

型号(model):LZL-RM-04

材料: 塑料PE

Material: Plastic PE

长度/Length: 1500mm

高度/Height: 1030mm

上宽/Width top: 150mm

下宽/Width bottom: 460mm

重量/Weight: 16kg±1kg



型号(model):LZL-RM-07

材料: 塑料PE

Material: Plastic PE

宽度/Length: 1500mm

高度/Height: 900mm

上宽/Width top: 150mm

下宽/Width bottom: 350mm

重量/Weight: 22kg



型号(model):LZL-RM-08

材料: 塑料PE

Material: Plastic PE

宽度/Length: 1400mm

高度/Height: 900mm

上宽/Width top: 200mm

下宽/Width bottom: 420mm

重量/Weight: 13kg



型号(model):LZL-RM-09

材料: 塑料PE、反光膜
 Material: Plastic PE
 长度/Length: 1500mm
 高度/Height: 800mm
 上宽/Width top:250mm
 下宽/Width bottom:450mm
 重量/Weight: 15kg±0.5kg



型号(model):LZL-RM-10

材料: 塑料PE
 Material: Plastic PE
 长度/Length: 1500mm
 高度/Height: 1600mm
 上宽/Width top: 150mm
 下宽/Width bottom: 500mm
 重量/Weight: 20kg±1kg



型号(model):LZL-RM-11

材料: 塑料PE、反光膜
 Material: Plastic PE
 长度/Length: 1000mm
 高度/Height: 800mm
 上宽/Width top: 200mm
 下宽/Width bottom: 560mm
 重量/Weight: 12kg±0.5kg



防撞桶 Anti-bump Barrel

型号(model):LZL-FZT-01

主要用于高速公路出口及各级公路十字路口, 收费站, 加油站, 对驾驶者有明显警示作用, 能降低肇事时人车伤亡的程度, 形成更安全, 更有效的保护。

材料: 塑料PE、反光膜
 高度: 820mm
 直径: 580mm

Warning marking barrel
 Mainly used to the exit of highway, road intersection, the charge station, the gas station. It is a clear warning for the drivers, and reduce the harm in the traffic accident, more safety and effective.
 Material: PLASTIC PE reflective sheeting
 Height:820mm
 Dia.:580mm



型号(model):LZL-FZT-02

主要用于高速公路出口及各级公路十字路口, 收费站, 加油站, 对驾驶者有明显警示作用, 能降低肇事时人车伤亡的程度, 形成更安全, 更有效的保护。

材料: 塑料PE、反光膜
 高度: 820mm
 直径: 580mm

Warning marking barrel
 Mainly used to the exit of highway, road intersection, the charge station, the gas station. It is a clear warning for the drivers, and reduce the harm in the traffic accident, more safety and effective.
 Material: PLASTIC PE reflective sheeting
 Height:820mm
 Dia.:580mm



型号(model):LZL-RM-12



| | |
|------------------------------|----------|
| 长度(L) | 1500mm |
| 上宽(top) | 80mm |
| 下宽(bottom) | 500mm |
| 高度(H) | 750mm |
| 装水量(Water Capacity) | 30kg |
| 拉伸强度(Tensile Strength) | 16.44MPa |
| 断裂伸长率(Elongation at Rupture) | 264% |
| 冲击强度(Lmpact Strength) | 20kj/cm |

型号(model):LZL-FZT-03

主要用于高速公路出口及各级公路十字路口, 收费站, 加油站, 对驾驶者有明显警示作用, 能降低肇事时人车伤亡的程度, 形成更安全, 更有效的保护。

材料: 塑料PE、反光膜
 高度: 920mm
 直径: 900mm

Warning marking barrel
 Mainly used to the exit of highway, road intersection, the charge station, the gas station. It is a clear warning for the drivers, and reduce the harm in the traffic accident, more safety and effective.
 Material: PLASTIC PE reflective sheeting
 Height:920mm
 Dia.:900mm



型号(model):LZL-FZT-04

材料: 塑料PE、反光膜
 长度: 900mm
 宽度: 900mm
 高度: 450mm

Material: PLASTIC PE reflective sheeting
 Length:900mm
 Width :900mm
 Height: 450mm

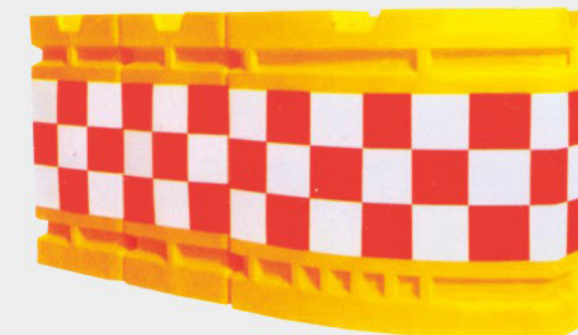

路锥用于道路分流管制等方面，具有防晒，不怕风吹雨打，耐热，耐寒，不裂等特点，同时反光效果好，附着力强。

路锥 Traffic cone

Traffic cone is mainly used for road diversion. With the characteristic of not afraid sun, wind, heat, cold, cracking.



型号(model):LZL-LZ-01

材料: 塑料PE、橡胶、反光膜
高度: 600mm
宽度: 420mm
Material: Plastic PE
Height: 600mm
Width :420mm



型号(model):LZL-LZ-02

材料: 塑料PE、反光膜
高度: 750mm
宽度: 400mm
Material: Plastic PE
Height: 750mm
Width :400mm



型号(model):LZL-LZ-03

材料: 塑料PE、反光膜
高度: 750mm
宽度: 400mm
Material: Plastic PE
Height: 750mm
Width :400mm



型号(model):LZL-LZ-02-A

材料: 塑料PE、反光膜
高度: 750mm
宽度: 400mm
Material: Plastic PE
Height: 750mm
Width :400mm



型号(model):LZL-LZ-02-B

材料: 塑料PE、反光膜
高度: 750mm
宽度: 400mm
Material: Plastic PE
Height: 750mm
Width :400mm

伸缩路锥 Traffic cone

型号(model):LZL-LZ-04
Telescopic Cone

| | |
|--------------|-----------|
| Traffic Cone | LZL-LZ-01 |
| Height | 700mm |
| Bottom | 400mm |
| Weight | 4.5kgs |



材料(material): 塑料PP(Plastic Pp)
防水荧光布(Water-resistant cloth),反光带(Reflective band)



| | | |
|--------------|--------------|--------------|
| LZL-LZ-05 | LZL-LZ-06 | LZL-LZ-07 |
| Height:700mm | Height:550mm | Height:450mm |
| Bottom:320mm | Bottom:300mm | Bottom:250mm |



LZL-LZ-07
Material:PP



LZL-LZ-08
Material:PP



LZL-LZ-09
Material:RUBBER



LZL-LZ-10
Material:PU

| | | | | |
|--------------|-----------|-------------|-----------|-----------|
| Traffic Cone | LZL-LZ-08 | LZL-LZ-08-A | LZL-LZ-09 | LZL-LZ-10 |
| Height | 300mm | 500mm | 700mm | 1000mm |
| Bottom | 200mm | 280mm | 400mm | 370mm |
| Weight | 0.27kgs | 0.6kgs | 2kgs | 5kgs |

◦ PVC路锥 *PVC Traffic cone*

路锥用于道路分流管制等方面，具有防晒，不怕风吹雨打，耐热，耐寒，不裂等特点，同时反光效果好，附着力强。
Traffic cone is mainly used for road diversion. With the characteristic of not afraid sun, wind, heat, cold, cracking.

型号(model):

| | | | |
|---------------|---------------|---------------|---------------|
| PVC Cone -01 | PVC Cone -02 | PVC Cone -03 | PVC Cone -04 |
| Height:900mm | Height:700mm | Height:450mm | Height:300mm |
| Bottom:360mm | Bottom:360mm | Bottom:270mm | Bottom:210mm |
| Weight:4.2kgs | Weight:3.2kgs | Weight:1.5kgs | Weight:1.1kgs |



900mm



700mm



450mm



300mm



型号(model):

| | | | |
|---------------|----------------------|---------------|---------------|
| PVC Cone-05 | PVC Cone-06 | PVC Cone-07 | PVC Cone-08 |
| Height:900mm | Height:700mm | Height:450mm | Height:300mm |
| Bottom:360mm | Bottom:360mm | Bottom:280mm | Bottom:210mm |
| Weight:4.2kgs | Weight:2.4kgs/1.8kgs | Weight:1.1kgs | Weight:0.6kgs |

◦ TPE路锥 *TPE Traffic cone*

型号(model):

| | | | |
|---------------|---------------|---------------|----------------|
| TPE Cone-01 | TPE Cone-02 | TPE Cone-03 | TPE Cone-04 |
| Height:900mm | Height:700mm | Height:450mm | Height:300mm |
| Bottom:360mm | Bottom:360mm | Bottom:280mm | Bottom:210mm |
| Weight:3.2kgs | Weight:1.5kgs | Weight:0.6kgs | Weight:0.45kgs |



LZL-LZ-11

| Model | Material | Size | Weight |
|----------|---|------------|-------------|
| LZ-11-01 | Plastic PE, rubber, reflective sheeting | 1000x480mm | 5/6/7KG |
| LZ-11-02 | | 750x380mm | 3.5/4/4.5KG |
| LZ-11-03 | | 500x280mm | 1.5/2KG |

LZL-LZ-12

| Model | Material | Size | Weight |
|----------|---|------------|--------|
| LZ-12-01 | Plastic PE, rubber, reflective sheeting | 1000x480mm | 5KG |
| LZ-12-02 | | 750x380mm | 2.5KG |
| LZ-12-03 | | 500x280mm | 1.5KG |



◦ 诱导柱 Guide post



LZL-YDZ-01

LZL-YDZ-02

LZL-YDZ-03

LZL-YDZ-04

| | |
|--------|-----------|
| YDZ | |
| Height | 1130mm |
| Dia. | 100mm |
| Weight | 6KGS/8KGS |

用于高速公路收费口, 人行道口。起临时性分隔道路, 分隔危险或禁止区域。用在交通护栏两端, 可于一次性警示带, 塑料警示链条, 外挂式警示灯配合使用。

Used at the charge station of highway, the intersection of road and the sidewalk. Used for separating road, danger or prohibited zone. Using at the both sides of parapet with the disposable warning band, plastic warning chain and warning lamps.



LZL-YDZ-05

LZL-YDZ-06

LZL-YDZ-07

LZL-YDZ-08



LZL-YDZ-PJ

◦ 诱导柱 Guide post

型号(model): LZL-YDZ-09

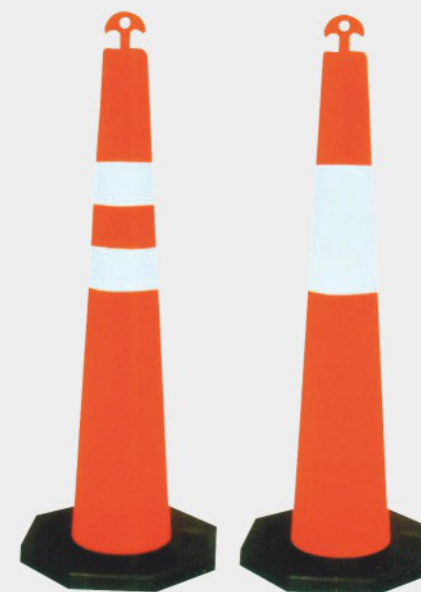

材料(material): 塑料PE(PLASTIC PE)
反光膜(rubber, reflective sheeting)
尺寸(size): 1160 x 200 x 100mm



| Model | Dia. | Height | Reflective Tape |
|------------|------|--------|-----------------|
| LZL-TXZ-01 | 10cm | 50cm | 15cm |
| LZL-TXZ-02 | 10cm | 80cm | 30cm |
| LZL-TXZ-03 | 10cm | 120cm | 45cm |



LZL-YDZ-10
Height: 950mm
Post Dia: 100mm
Base Dia: 380mm
weight: 6.5kg



LZL-YDZ-11
Height: 950mm
Post Dia: 100mm
Base Dia: 380mm
weight: 6kg

◦ 警示柱 *Warning post*

型号(model):LZL-JSZ-01



高度: 850mm 重量: 0.5kgs

型号(model):LZL-JSZ-02

高度: 1150mmX120mm 重量: 3kgs
高度: 1000mmX60mm 重量: 1.8kgs

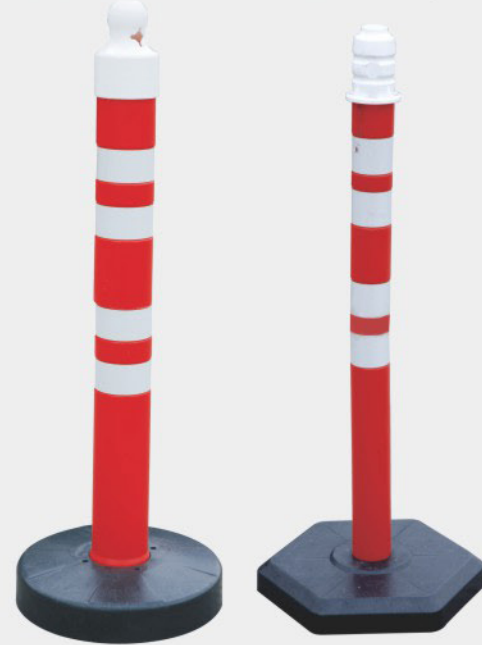

◦ *TPE post*

型号(model):LZL-PE-01



型号(model):LZL-PE-02



| MATERIAL | PE-01 | PE-02 |
|----------|--------|--------|
| Height | 750mm | 450mm |
| Dia | 80mm | 80mm |
| weight | 0.65kg | 0.45kg |

◦ *TPU post*

型号(model):LZL-TPU-01



型号(model):LZL-TPU-02



| MATERIAL | TPU-01 | TPU-02 |
|----------|--------|--------|
| Height | 750mm | 450mm |
| Dia | 200mm | 200mm |
| Top | 80mm | 80mm |
| weight | 1.3kg | 0.7kg |



LZL-JSZ-PJ-02



◦ 警示板 Flexible guide pannel

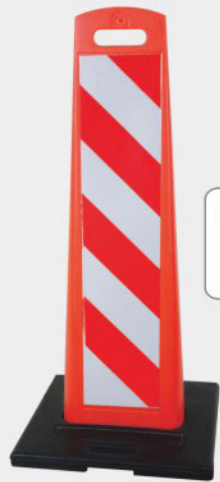

型号(model):LZL-J5B-01

材料(material): 橡胶 PE(Plastic PE)
尺寸(size):1100×310mm
重量 (Weight) :13KGS



型号(model):LZL-J5B-02

材料(material): 橡胶 PE(Plastic PE)
尺寸(size):1100×290mm
重量 (Weight) :25KGS
底座(Base): 20kgs



标志部分尺寸: 240X745mm
反光膜尺寸: 200X480
标志部分材料: 高密度聚乙烯 (防晒度达八级)
标志部分重量: 2公斤
底座材料: 橡胶
底座重量: 12公斤
产品能在-30° C至50° C温度下使用
Delineator:240*745mm(H*W)
Sheeting:200*480mm(H*W)
Panle Matrial:High Density Polythene
(snning resistant can meet eight-grade)
Panel Wright:2kgs
Base:680*310*40mm(L*W*T)
Base Material:Rubber
Base Weight:12kgs
Operation in the surrounding through
-30° C to 50° C



型号(model):LZL-J5B-03

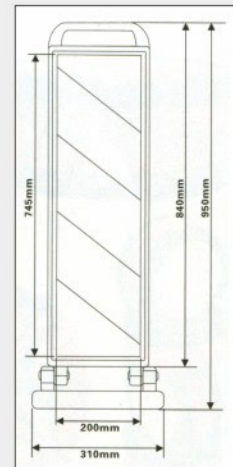

型号(model):LZL-J5B-04

材料(material): TPU
尺寸(size):200×134×270mm
重量 (Weight) :0.55kg



◦ A字折叠板



型号(model):LZL-AB-01

材料(material): PE(Plastic PE)
尺寸(size):1060×645×80mm
重量 (Weight) :9KGS±0.5KGS



型号(model):LZL-AB-02

材料(material): PE(Plastic PE)
尺寸(size):1000×450X60mm
重量 (Weight) :6KGS±0.5KGS



型号(model):LZL-AB-03

材料(material): pp
尺寸(size):630X210X630mm



型号(model):LZL-AB-04

材料(material): Plastic
尺寸(size):950X280X280mm
重量 (Weight) :1.2kg

隔离墩



型号 (model) : LZL-GLD-01
材料 (material) : 塑料ABS (Plastic ABS)
PC反光片 (PC reflector)
尺寸 (size) : 800×360mm



安全踏板 Trench Cover

人行道安全施工的理想备最高负荷重：1000KGS/SQ/M

- 1.标准色为绿色，蓝色，黄色（其他颜色也可以提供）
- 2.斜面设计有助于减缓交通以提高安全性
- 3.可配置修边
- 4.对行人无害
- 5.背面有钢板支撑
- 6.每块坑板两边都带有公母连接设计，可以方便安全的连接起来
- 7.在空白的部分可以带上客户的LOGO，但是有数量限制。

Ideal for safe working on wide pavement excavations

Maximum loading weight:5000KGS/SQ/M

- 1.standard color green(other colors available, and MOQ for each color is 400pcs)
- 2.Ramp design helps slowing down traffic for increased safety
- 3.Ending accessory available
- 4.No trip hazard for pedestrians
- 5.Each cover is fitted with steel on the backside
- 6.Each Trench Cover has female and male linking bracket system in both side connect easily and secyrelly together
- 7.The insert part can be replaced with logo as client request,but subject to minimum order

型号(model):LZL-AQTB-01



Material:PE
Size:1400x800mm
Weight:20kg
Packing:450pcs/20' container
MOQ:450PCS

型号(model):LZL-AQTB-02



Material:PE
Size:1400x800mm weight:20kg
Packing:35pcs per pallet,450pcs/20' container
MOQ:450PCS

型号(model):LZL-AQTB-03

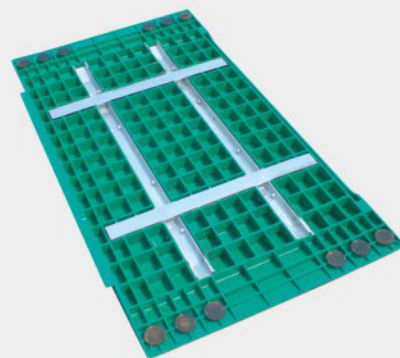

Trench Safety Cover
2000x600mm

型号(model):LZL-AQTB-04



Colour coded product option
(Subject to minium order)

安全踏板 Trench Cover



Pedestrian bridge is suited by plastic cover galvanized iron barriers. With the smart joint system, utilized in roadside work. It's durable and won't rust. Perfect for outdoor activities. Available in yellow, green, blue color for trench covers, blank area in cover can stamp the logo.

人行桥由塑料踏板和镀锌铁栅栏组合而成，是人行道安全施工的理想产品。塑料踏板有多种颜色供选择，如：绿色、黄色、蓝色。不生锈耐腐蚀，具备耐用，轻巧，环保安全等优点。独特的设计，便于搬运，安装和使用。

型号(model):LZL-AQTB-06

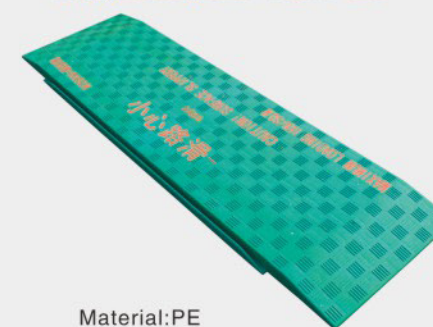

Material:PE
Size:2000x600mm
Weight:33kg
Packing:650pcs/20' container
MOQ:650PCS

型号(model):LZL-AQTB-07

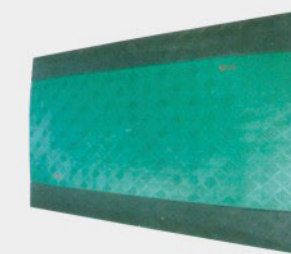

ENDING PART
Size:2000x200mm
Weight:45.7kg

型号(model):LZL-AQTB-08



ENDINGPART
Size:1400x200mm
Weight:32kg/couple

LZL-AQTB-05



◦ 路障警示灯 *Warning lamps*

Battery lamp



型号(model):LZL-J50-01



型号(model):LZL-J50-02



型号(model):LZL-J50-03



型号(model):LZL-J50-04



型号(model):LZL-J50-05



LZL-J50-06



LZL-J50-07



LZL-J50-08



LZL-J50-09



LZL-J50-10



ZL-J50-11



LZL-J50-12

◦ 路障警示灯 *Warning lamps*

Solar lamp



LZL-J50-13



LZL-J50-14



LZL-J50-15



LZL-J50-16



LZL-J50-17

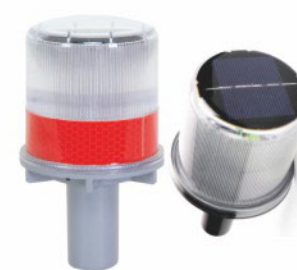

LZL-J50-18



LZL-J50-19



180X120MM
LZL-J50-20



LZL-J50-21



LZL-J50-22



LZL-J50-23



LZL-J50-24



LZL-J50-25

◦路障警示灯 *Warning lamps*

SOLAR SIGN



Size:300X300X130mm
型号(model):LZL-SL-01



Size:300X300X130mm
型号(model):LZL-SL-02



Size:300X300X130mm
型号(model):LZL-SL-03



Size:350X250mm
型号(model):LZL-SL-04



Size:600X250X270mm
型号(model):LZL-SL-05



太阳能爆闪灯600×350×270
型号(model):LZL-SL-06



太阳能爆闪灯600×200
型号(model):LZL-SL-07



Size:300X150X120mm
型号(model):LZL-SL-08



短排警灯600×350×270
型号(model):LZL-SL-09

◦路障警示灯 *Warning lamps*

SOLAR SIGN



Size:600X350X270mm
型号(model):LZL-SL-10



250X150X100mm
型号(model):LZL-SL-11



Size:750X250X130mm
型号(model):LZL-SL-12



Size:800X252X270mm
型号(model):LZL-SL-13



Size:550X150X130mm
型号(model):LZL-SL-14



Size:1000X300X130mm
型号(model):LZL-SL-15



Size:550X150X130mm
型号(model):LZL-SL-16



Size: 500X150X130mm
型号(model):LZL-SL-17



太阳能爆闪灯800×200
型号(model):LZL-SL-18

◦ 路障警示灯 Warning lamps



太阳能工程指示车 (大车) 超亮
指示屏尺寸: 1600×800
灯筒尺寸: φ100

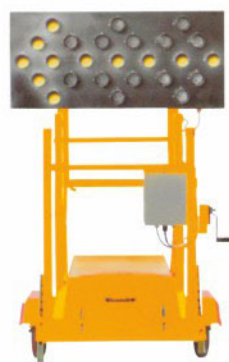

太阳能工程指示车 (小车)
指示屏尺寸: 1200×600
1400×600
灯筒尺寸: φ175



太阳能施工标志



太阳能线型诱导标志
1400×400
(可变左右导向)



太阳能简易式导向牌
1400×600
(特点方便实惠)



太阳能导向灯
1200×400



300X300mm



300X300mm



300X300mm



200X200mm



300X300mm



300X300mm

◦ 路障警示灯 Warning lamps



Size: 300X300mm/
400X400mm



Size: 740X380X130mm



Size: 1060X350X130mm/
1410X480X140mm



Size: 1060X350X130mm/
1410X480X140mm



Size: 1060X150X130mm/
1410X480X140mm



1410X480X140mm



Size: 1000mm/ 800mm/600mm



Size: 1000mm/800mm/600mm



Size: 1400X800mm



Size: 1200X600mm



Size: 800X600mm



Size: 900mm/ 700mm



Length: 1200mm



Length: 1200mm



Length: 1200mm



Length: 1200mm



Length: 1200mm



120X750X80MM



120x750x80MM



Size: 680X860mm



太阳能旋转灯 (Rotating lamp)
Size: 550 X170mm



Size: Height: 1.8m



Size: Height: 2.1m



Size: Height: 1.6m

◦ 全塑胶临时路牌 *Plastic Cone sign*

- 1、新工艺、新技术的塑料路牌；
- 2、坚固及耐用的设计；
- 3、耐候性强，还具有相当的柔韧度，绝不生锈；
- 4、灰色/白色的高密度聚乙烯制造；
- 5、轻便但稳定性好；
- 6、容易清洗，产品圆滑，便于移动；
- 7、可以完全循环回收；
- 8、能紧凑堆叠，储存和运输方便；

New revolution for plastic sign in Blowmoulding
Extremely strong and robust design giving durability and long life-NO RUST!
Manufactured from HDPE in grey/white
Excellent weight and footprint stability
Non flammable
Easy and safe to handle i.e.no sharp edges
Priced competitive
Can be recycled at the end life
Stackable for storage and transport



型号(model):LZL-LP-01

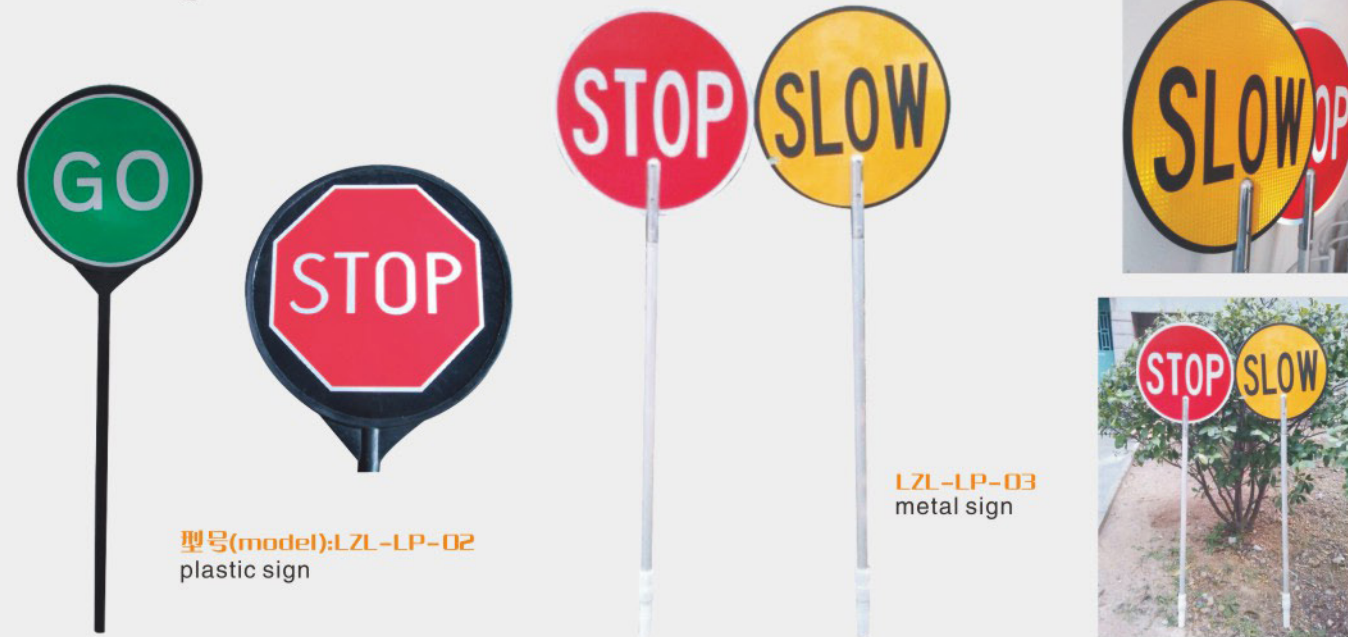

型号(model):LZL-LP-02
plastic sign

LZL-LP-03
metal sign

◦ 塑料减速带 *Plastic Speed humps*

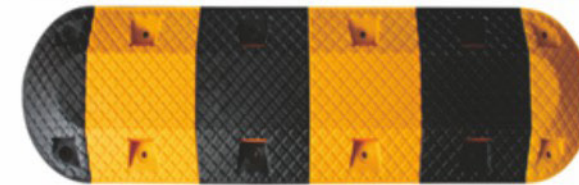

LZL-PSH-01
Middle Size: 250x350x50mm
End Cap Size: 170X350X50mm
weight: 5.4kg



LZL-PSH-02
Middle Size: 500x320x40mm
End Cap Size: 170X320X40mm
weight:2.5kg



LZL-PSH-03
Middle Size:500X350X40mm
End Cap Size:170X350X40mm
weight: 4.6kg



Size: 500X160X100 mm weight: 1.6kg

◦ 塑料护角器



材料: material :plastic
size : 800X90X5mm
weight: 0.45kg

TPU Post
Height:750mm
Dia: 200mm
top :80mm
weight: 1.3kg

PE Post
Height:750mm
Dia:200mm
top:80mm
weight: 0.6kg

◦ 减速带 Speed humps

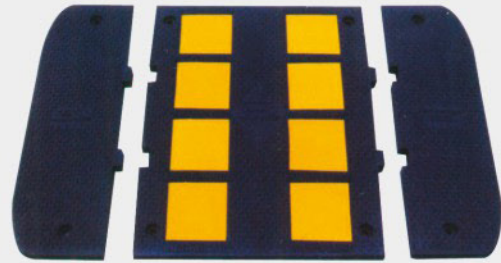

| Model | Middle Size | End Cap Size |
|-----------|--------------|--------------|
| 型号 | 中段尺寸 | 端头尺寸 |
| LZL-SH-01 | 500X600X32mm | 200x600x32mm |



| Model | Middle Size | End Cap Size |
|-----------|--------------|--------------|
| 型号 | 中段尺寸 | 端头尺寸 |
| LZL-SH-02 | 500X900X50mm | 200x900x50mm |



| Model | Middle Size | End Cap Size |
|-----------|---------------|---------------|
| 型号 | 中段尺寸 | 端头尺寸 |
| LZL-SH-03 | 500X1000X75mm | 250x1000x50mm |



| Model | Middle Size | End Cap Size |
|-----------|--------------|--------------|
| 型号 | 中段尺寸 | 端头尺寸 |
| LZL-SH-04 | 500X550X75mm | 250x550x75mm |

◦ 人行安全岛 Safety Island



人行安全岛: L1000xW700xH300mm 70kg/pc
 Island End
 行人停踏板: L1000xW700xH60mm 35kg/pc
 Pedestrian stand
 红白双色警示注: H:1100mm 0.8kg/pc
 Red-white Warning Post
 整组重量Total Weight: 280kg/set

◦ 减速带 Speed humps



| Model | Middle Size | End Cap Size |
|-----------|--------------|--------------|
| 型号 | 中段尺寸 | 端头尺寸 |
| LZL-SH-05 | 500X350X50mm | 250x350x50mm |
| LZL-SH-06 | 250X350X50mm | 250x350x50mm |



| Model | Middle Size | End Cap Size |
|-----------|---------------|--------------|
| 型号 | 中段尺寸 | 端头尺寸 |
| LZL-SH-07 | 1000X300X45mm | 250x300x45mm |
| LZL-SH-08 | 1000X330X50mm | 250x330x50mm |
| LZL-SH-09 | 1000X380X50mm | 250x380x50mm |



| Model | Middle Size | End Cap Size |
|-----------|---------------|--------------|
| 型号 | 中段尺寸 | 端头尺寸 |
| LZL-SH-10 | 1000X350X50mm | 250x350x50mm |

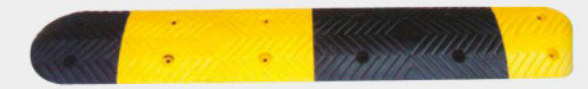

| Model | Middle Size | End Cap Size |
|-----------|--------------|--------------|
| 型号 | 中段尺寸 | 端头尺寸 |
| LZL-SH-11 | 500X250X35mm | 250x250x35mm |



| Model | Middle Size | End Cap Size |
|-----------|---------------|--------------|
| 型号 | 中段尺寸 | 端头尺寸 |
| LZL-SH-12 | 1000X300X45mm | 250x300x45mm |
| LZL-SH-13 | 1000X300X45mm | 250x300x45mm |



| Model | Middle Size | End Cap Size |
|-----------|--------------|--------------|
| 型号 | 中段尺寸 | 端头尺寸 |
| LZL-SH-14 | 250X350X50mm | 250x350x50mm |



| Model | Middle Size | End Cap Size |
|-----------|---------------|--------------|
| 型号 | 中段尺寸 | 端头尺寸 |
| LZL-SH-15 | 1000X450X60mm | 250x450x60mm |



| Model | Middle Size | End Cap Size |
|-----------|---------------|--------------|
| 型号 | 中段尺寸 | 端头尺寸 |
| LZL-SH-16 | 1000X300X45mm | 250x300x45mm |

◦ 停车场设施 Parking solution



Model 型号:LZL-DWQ-01
Sizen 尺寸:50x15x10cm



Model 型号:LZL-DWQ-02
Sizen 尺寸:50x17x13cm



Model 型号:LZL-DWQ-03
Sizen 尺寸:60x14x11cm



Model 型号:LZL-DWQ-04
Sizen 尺寸:90x15x11cm



Model 型号:LZL-DWQ-05
Sizen 尺寸:165x14x10cm



Model 型号:LZL-DWQ-06
Sizen 尺寸:160x14x10cm



Model 型号:LZL-DWQ-07
Sizen 尺寸:183x15x11cm



| Model 型号 | Sizen 尺寸 | Color 颜色 |
|----------|---------------|--------------------------|
| | 200x100x150mm | Black or Yellow 黑色/黄色 |
| | 270x120x180mm | |

Material:rubber 材质:橡胶

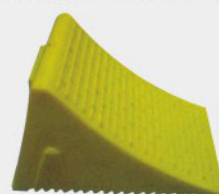

Model 型号:LZL-DWQ-08
Sizen 尺寸:190x105x125mm
Material:plastic 材质:塑料



Model 型号:LZL-HJ-01
Height 高度:800mm/1000mm
Thickness 厚度:35mm



Model 型号:LZL-HJ-02
Height 高度:800mm/1000mm
Thickness 厚度:10mm



Model 型号:LZL-HJ-03
Height 高度:1000mm
Thickness 厚度:10mm

◦ 塑料线槽 Cable protector

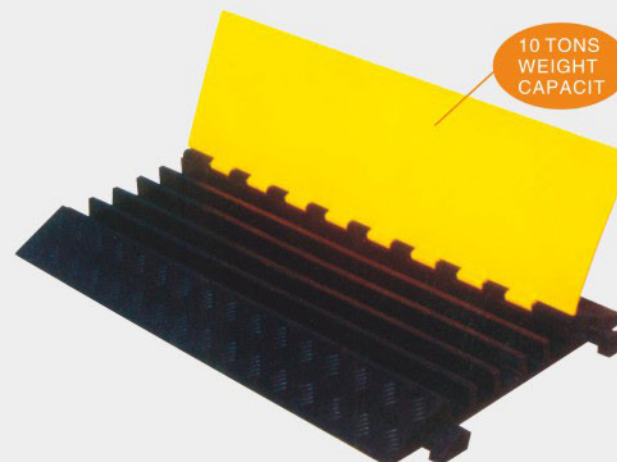

10 TONS
WEIGHT
CAPACIT

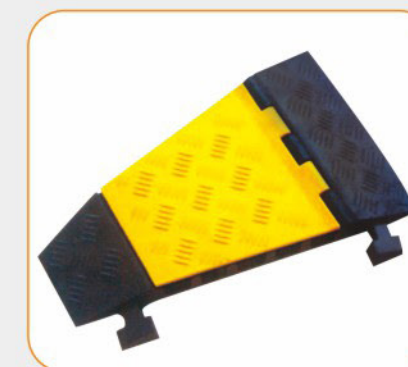

| Model (型号) | Channel (孔数) | Channel size (孔直径) | Length (长) | Width (宽) | Height (高) | Weight (重量) |
|--------------|----------------|----------------------|--------------|-------------|--------------|---------------|
| LZL-CX-01 | 5 | φ 42mmx5mm | 900mm | 500mm | 55mm | 16kg |
| LZL-CX-02 | 5 | □ φ 42mmx5mm | 310mm | 500mm | 55mm | 4kg |



5 TONS
WEIGHT
CAPACIT



| Model (型号) | Channel (孔数) | Channel size (孔直径) | Length (长) | Width (宽) | Height (高) | Weight (重量) |
|--------------|----------------|----------------------|--------------|-------------|--------------|---------------|
| LZL-CX-03 | 2 | φ 30mmx2mm | 1000mm | 250mm | 45mm | 7.5kg |
| LZL-CX-04 | 2 | □ φ 30mmx2mm | 400mm | 250mm | 45mm | 2.5kg |

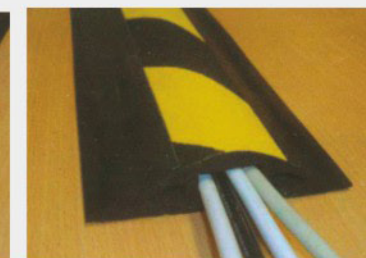

| Model | Width | Height | Dia.of Middle hole | Length/roll |
|-----------|-------|--------|--------------------|-------------|
| 型号 | 宽度 | 高度 | 孔径 | 长度/卷 |
| LZL-CX-05 | 70mm | 16mm | 17.5x9mm | 10m |
| LZL-CX-06 | 120mm | 26mm | 23x18mm | 10m |

◦ 广角镜 *Traffic mirror*

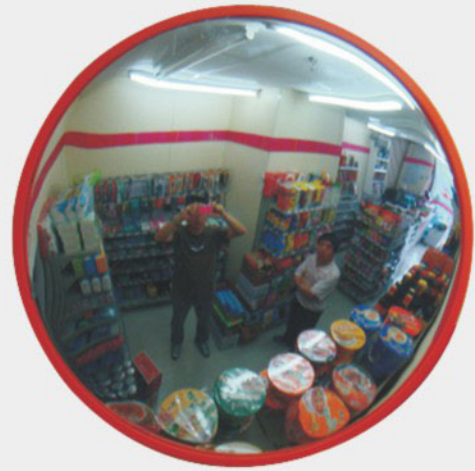

型号(Model):LZL-GJJ-01
indoor: φ 30/45/60cm



型号(Model):LZL-GJJ-02
outdoor: φ 30/45/60/80/100cm



型号(Model):LZL-GJJ-03
360° 1/2球面镜

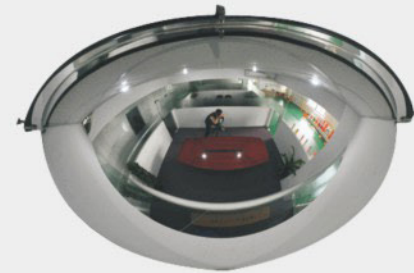

型号(Model):LZL-GJJ-04
360° 1/4球面镜



型号(Model):LZL-GJJ-05
360° 1/8球面镜

◦ 伸缩杆

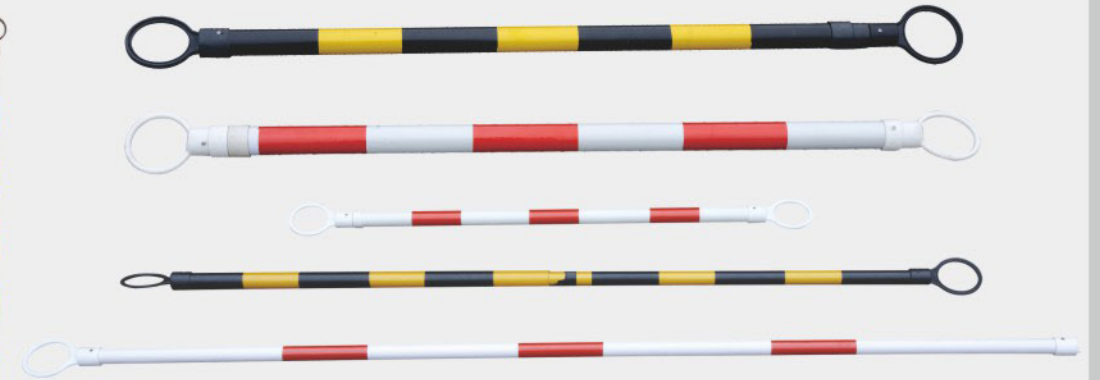

型号(Model):LZL-GLG-01

◦ 反光线绳 *Reflector Line*

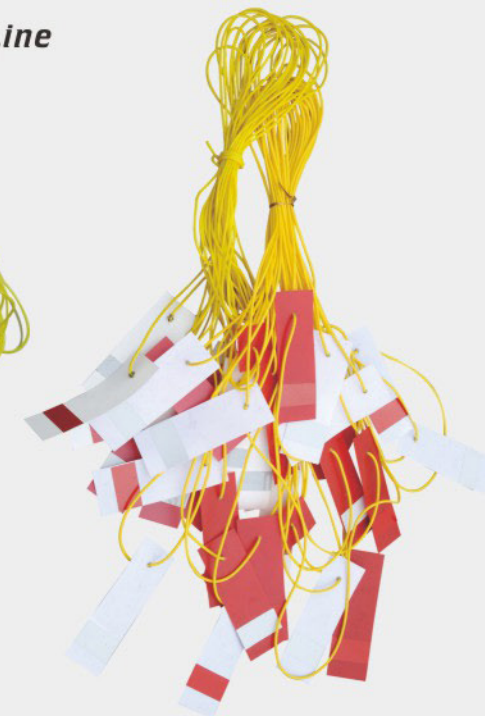

型号(Model):LZL-RL-01

◦ 道钉 Road Studs



型号(model):LZL-DD-01
材料(material):塑料(plastic);
PC反光片(PCreflective sheeting)
规格(specification):单面(single-side)
反光(reflective)
尺寸(size):100 × 100 × 20mm



型号(model):LZL-DD-02
材料(material):塑料(plastic);
PC反光片(PCreflective sheeting)
规格(specification):双面(double-side)
反光(reflective)
尺寸(size):100 × 100 × 20mm



型号(model):LZL-DD-03
材料(material):塑料(plastic);
PC反光片(PCreflective sheeting)
规格(specification):单面或双面反光
(single or double-side)
尺寸(size):100 × 100 × 20mm

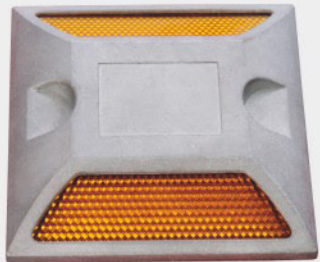

型号(model):LZL-DD-04
材料(material):
全铝(complete aluminium);
PC反光片(PCreflective sheeting)
规格(specification):单面或双面反光
(single or double-side)
尺寸(size):100 × 100 × 20mm



型号(model):LZL-DD-05
材料(material):铝(aluminium);
太阳能电池(solar battery)
尺寸(size):148 × 122 × 32mm



型号(model):LZL-DD-06
材料(material):铝(aluminium);
太阳能电池(solar battery)
尺寸(size):130x118MM



型号(model):LZL-DD-07
材料(material):铝(aluminium);
太阳能电池(solar battery)
尺寸(size):110 × 95 × 23mm



型号(model):LZL-DD-08
材料(material):铝(aluminium);
太阳能电池(solar battery)
尺寸(size):112MM



型号(model):LZL-DD-09
材料(material):塑料(plastic);
PC反光片(PCreflective sheeting)
规格(specification):单面(single-side)
反光(reflective)
尺寸(size):114X114X20mm



型号(model):LZL-DD-10
材料(material):塑料(plastic);
PC反光片(PCreflective sheeting)
规格(specification):双面(double-side)
反光(reflective)
尺寸(size):110X95X23mm

◦ 轮廓标 Post delineator

型号(model):LZL-LKB-01

材料(material):
钢支架或者塑料支架
(Steel or plastic bracket);
PC反光片(PC reflector)
规格(specification):
单支单面
(single bracket single-side),
尺寸(size): 120 × 70 × 50mm

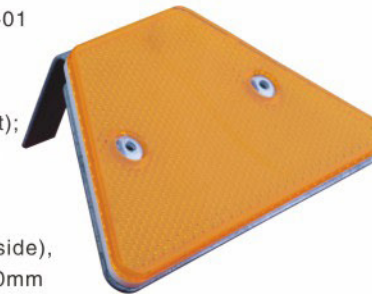

型号(model):LZL-LKB-02

材料(material):
钢支架或者塑料支架
(Steel or plastic bracket);
PC反光片(PC reflector)
规格(specification):
双支单面(double bracket single-side)
尺寸(size): 120 × 70 × 50mm

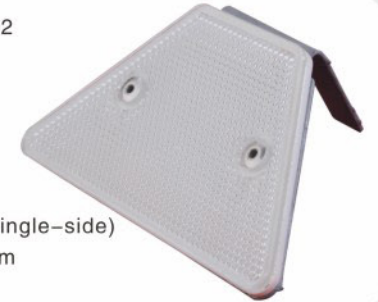

型号(model):LZL-LKB-03

材料(material):
钢支架或者塑料支架
(Steel or plastic bracket);
PC反光片(PC reflector)
规格(specification):
双支单面(double bracket single-side)
尺寸(size): 120 × 70 × 50mm



型号(model):LZL-LKB-04

材料(material):
塑料支架(Plastic bracket);
PC反光片(PC reflector)
规格(specification):
双面(double-side)
尺寸(size): 180 × 40mm

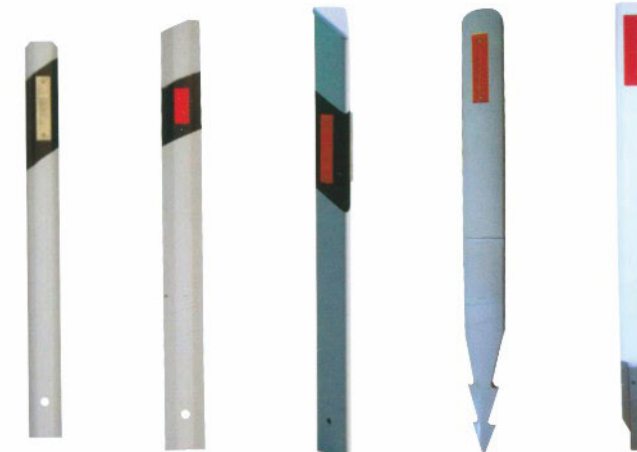

| Model No | Material | Height |
|------------|----------|--------|
| LZL-LKB-01 | PVC | 110cm |
| LZL-LKB-02 | PVC | 120cm |
| LZL-LKB-03 | PVC | 125cm |
| LZL-LKB-04 | PVC | 125cm |
| LZL-LKB-05 | PVC | 125cm |

◦ 塑料安全网 *Plastic Fence*

LZL-AQW-01

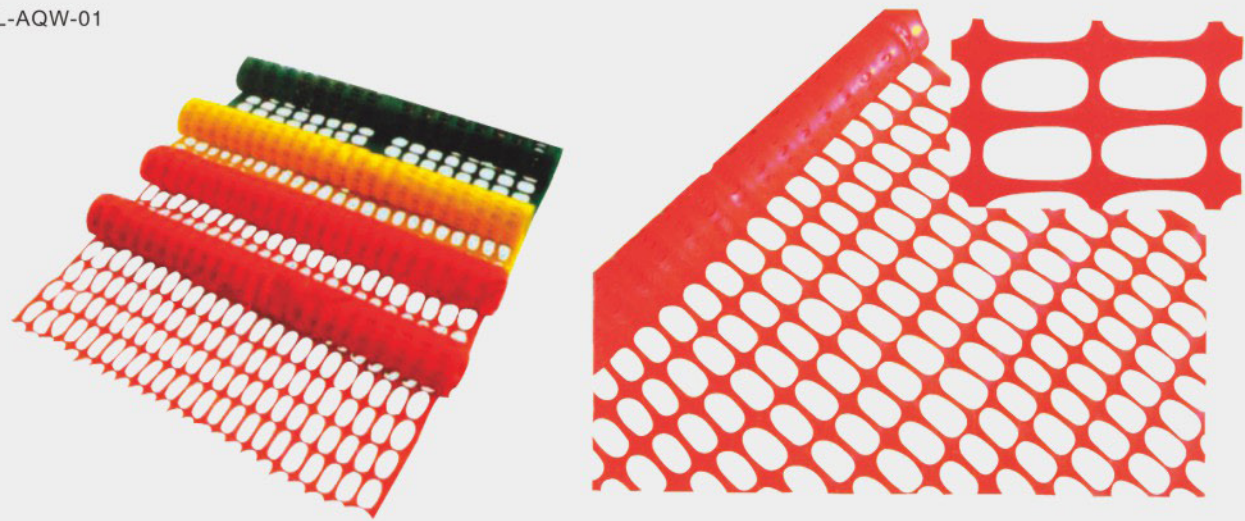

LZL-JSL-01

Plastic chain

塑料链条有多种规格, 多种颜色, 可生产任意长度, 其主要用于公路防护, 酒店, 商场, 运动场所及公共场所的通道隔离。

Plastic chains have many different specifications, various colors and could be produced in any length, which is mainly used in highway protection and channel isolation of hotels, shopping malls, sportfields and public places!

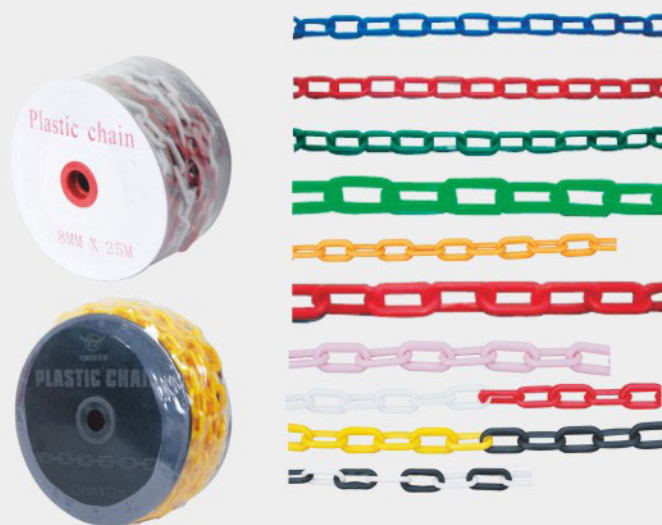

◦ 警示带 *Warning Tape/safety tape*

Aluminum foil detectable warning tape,
Detectable warning tape

Warning tape, caution tape,
barricade tape

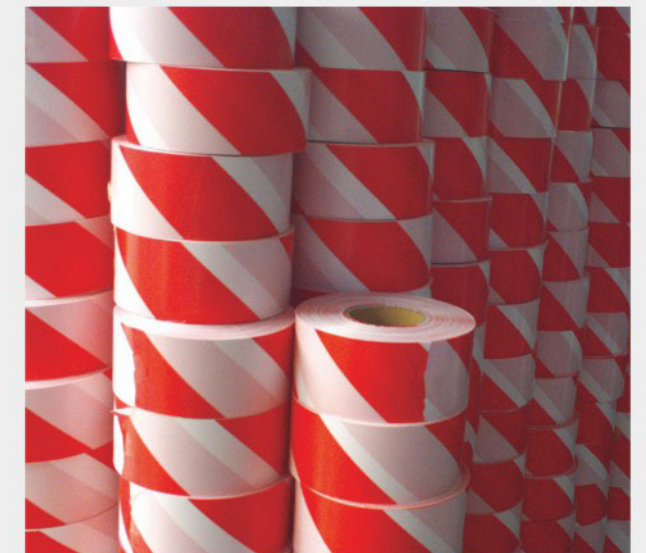
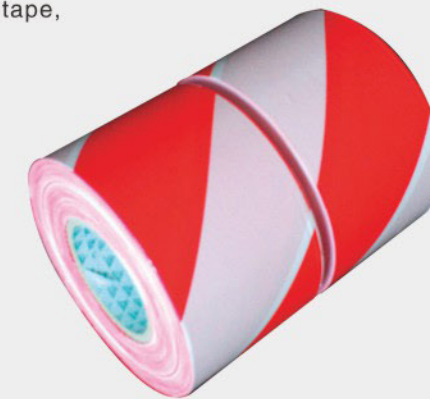

◦ 车身贴

LZL-CST-01



◦ 防眩板 *Anti-dazzle pannel*



LZL-FXB-01 LZL-FXB-02 LZL-FXB-03 LZL-FXB-04 LZL-FXB-05

材料(material): 橡胶PE(Plastic PE)
尺寸(size): 900 × 220 × 45mm



LZL-FXB-06 LZL-FXB-07

材料(material): 玻璃钢
(glass reinforced plastics)
尺寸(size): 850 × 240 × 35mm

◦ 隔离带 *Isolation belt*

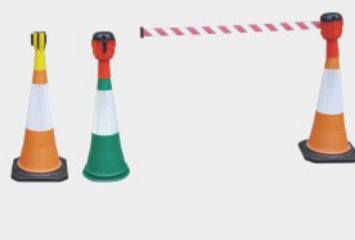

型号 (model) : LZL-GLD-01
产品尺寸: 100 × 220mm
主题颜色: 橙色/红色/绿色
拉带长度: 5米

Size: ϕ 100 × 220mm
Color: Orange/Red/Green
Tape length: 5m



型号 (model) : LZL-GLD-02
产品尺寸: 130 × 230mm
主题颜色: 橙色/红色/绿色
拉带长度: 10米

Size: ϕ 130 × 230mm
Color: Orange/Red/Green
Tape length: 10m



◦ 塑料安全盖 *Safety Cover*



ϕ 10~ ϕ 20钢筋套



ϕ 20~ ϕ 40钢筋套



脚手架带环钢管保护套



脚手架带环连接件螺丝保护套



脚手架连接件保护套



脚手架钢管保护套



◦ 安全服装 Reflective Vests



型号(model):LZL-YF-01
材料(material):全涤纶, 反光带
(Polyester reflective belt)



型号(model):LZL-YF-02
材料(material):全涤纶, 反光带
(Polyester reflective belt)



型号(model):LZL-YF-03
材料(material):全涤纶, 反光带
(Polyester reflective belt)



型号(model):LZL-YF-04
材料(material):全涤纶, 反光带
(Polyester reflective belt)



型号(model):LZL-YF-05
材料(material):全涤纶, 反光带
(Polyester reflective belt)



型号(model):LZL-YF-06
材料(material):全涤纶, 反光带
(Polyester reflective belt)



型号(model):LZL-YF-04
材料(material):全涤纶, 反光带
(Polyester reflective belt)



型号(model):LZL-YF-05
材料(material):全涤纶, 反光带
(Polyester reflective belt)



型号(model):LZL-YF-06
材料(material):全涤纶, 反光带
(Polyester reflective belt)

◦ 安全头盔 Safety helmet

LZL-TK-01



| | |
|----------|--------|
| Model | DA-4-6 |
| Weight | 410g |
| Size | 55-65 |
| Length | 262mm |
| Width | 230mm |
| Height | 157mm |
| Material | ABS |



LZL-TK-02



| | |
|----------|--------|
| Model | DA-4-6 |
| Weight | 370g |
| Size | 54-64 |
| Length | 270mm |
| Width | 235mm |
| Height | 175mm |
| Material | ABS |



LZL-TK-03



| | |
|----------|--------|
| Model | DA-4-6 |
| Weight | 356g |
| Size | 55-65 |
| Length | 295mm |
| Width | 220mm |
| Height | 146mm |
| Material | PP/PE |



LZL-TK-04



| | |
|----------|--------|
| Model | DA-4-6 |
| Weight | 380g |
| Size | 55-65 |
| Length | 262mm |
| Width | 230mm |
| Height | 157mm |
| Material | ABS |



LZL-TK-05



| | |
|----------|--------|
| Model | DA-4-6 |
| Weight | 356g |
| Size | 55-65 |
| Length | 295mm |
| Width | 220mm |
| Height | 146mm |
| Material | PP/PE |



LZL-TK-06



| | |
|----------|--------|
| Model | DA-4-6 |
| Weight | 380g |
| Size | 55-65 |
| Length | 262mm |
| Width | 230mm |
| Height | 157mm |
| Material | ABS |

◦ 指挥棒 *Reflective baton*

LZL-ZHB-01



| Model | Size | Function | Batteries |
|--------|----------------|---------------------------------|-----------------|
| ZHB-01 | (L)52 × (DIA)3 | Flash-Steady-White Light-Closed | Two C Batteries |

临时路标

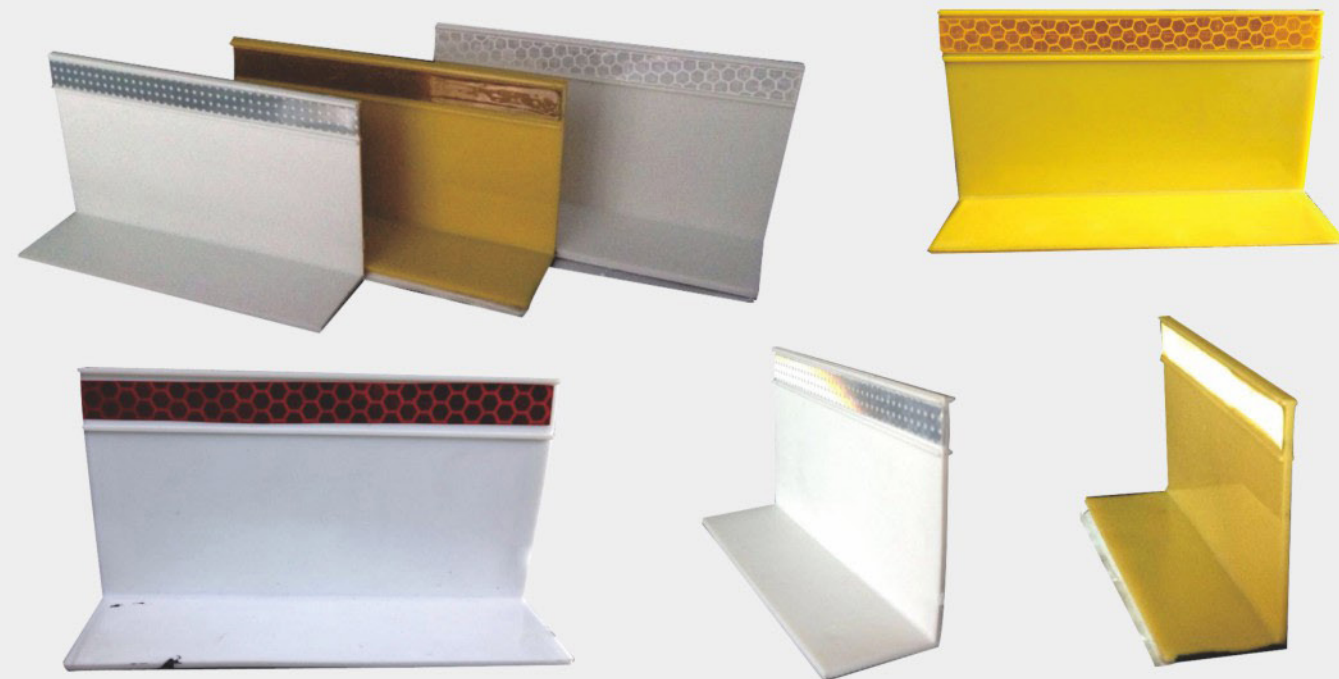

◦ 三角警示牌 *Warning triangle*



型号 (model) : LZL-JSP-01

尺寸(size):边长 (length) 55mm
材料(material):塑料PC镜面反光片, 铁架 (Plastic PC reflective sheeting, steel bracket)



型号 (model) : LZL-JSP-02

尺寸(size):边长 (length) 55mm
材料(material):塑料PC镜面反光片, 铁架 (Plastic PC reflective sheeting, steel bracket)

◦ 车位锁 *Parking Lock*



型号:LZL-CWS-01

尺寸(size):600 × 200 × 65mm
600 × 180 × 55mm
材料(material):优质钢材 (high quality steel)
手动的 (manual)



型号:LZL-CWS-02

尺寸(size):500 × 700 × 50mm
500 × 600 × 50mm
材料(material):优质钢材 (high quality steel)
手动的 (manual)



型号:LZL-CWS-03

尺寸(size):400 × 470 × 80mm
材料(material):优质钢材 (high quality steel)
遥控的 (remote controlled)



型号:LZL-CWS-04

尺寸(size):400 × 470 × 80mm
材料(material):优质钢材 (high quality steel)
遥控的 (remote controlled)

◦ 反光膜 *Reflective Sheeting*

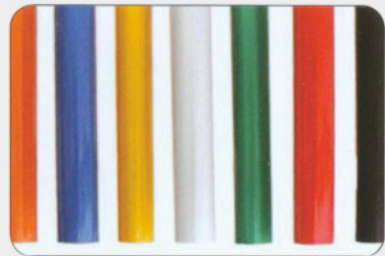

LZL-8200
Plat Grade Reflective Sheeting



LZL-3200
PET Advertisement Grade Reflective Sheeting



LZL-3100
Acrylic Advertisement Grade Reflective Sheeting



LZL-5200
PET Engineering Grade Reflective Sheeting



LZL-7200
Acrylic Engineering Grade Reflective Sheeting



LZL-1200
High Intensity Reflective Sheeting

超高级3-5年膜



LZL-3000

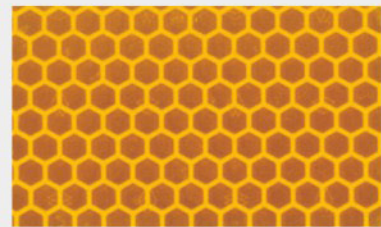

LZL-3001

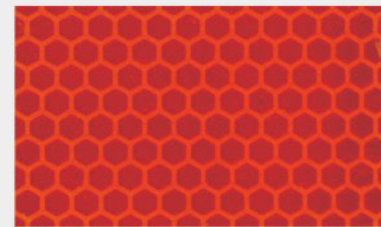

LZL-3002



LZL-2000



LZL-2001



LZL-2002

◦ 吹塑划艇 *Blow Rowboat*

儿童划艇
Childrens Rowboat
尺寸:1700X590mm

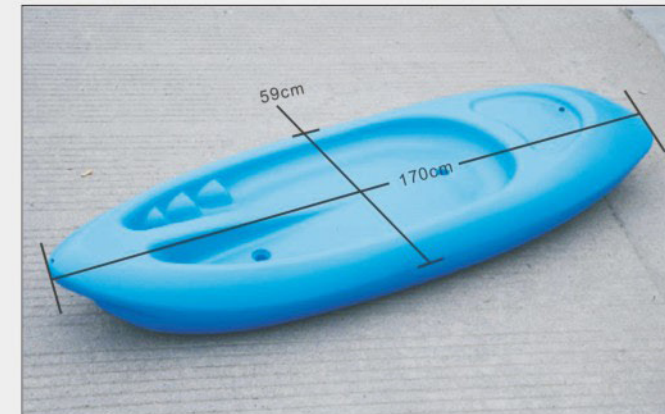

成人划艇 *Rowboat*
尺寸:2300X1140mm

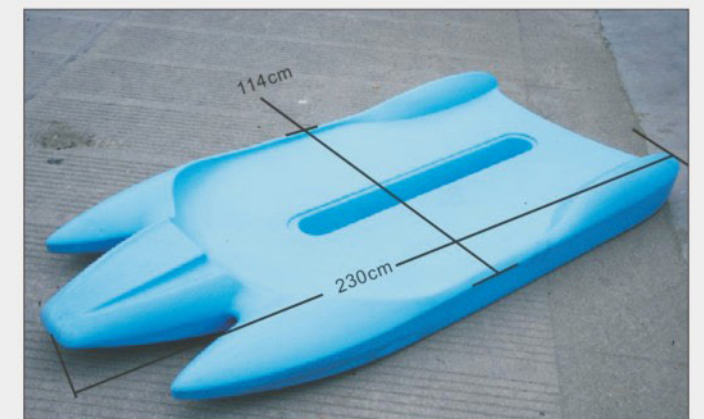

◦ 浮桶 Floating barrels

Various design floating barrels, sea leisure products.

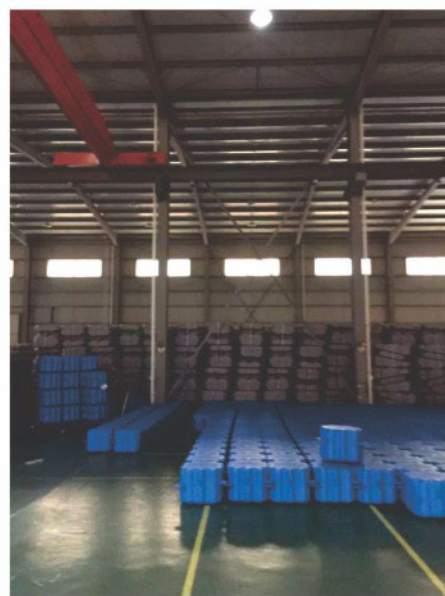
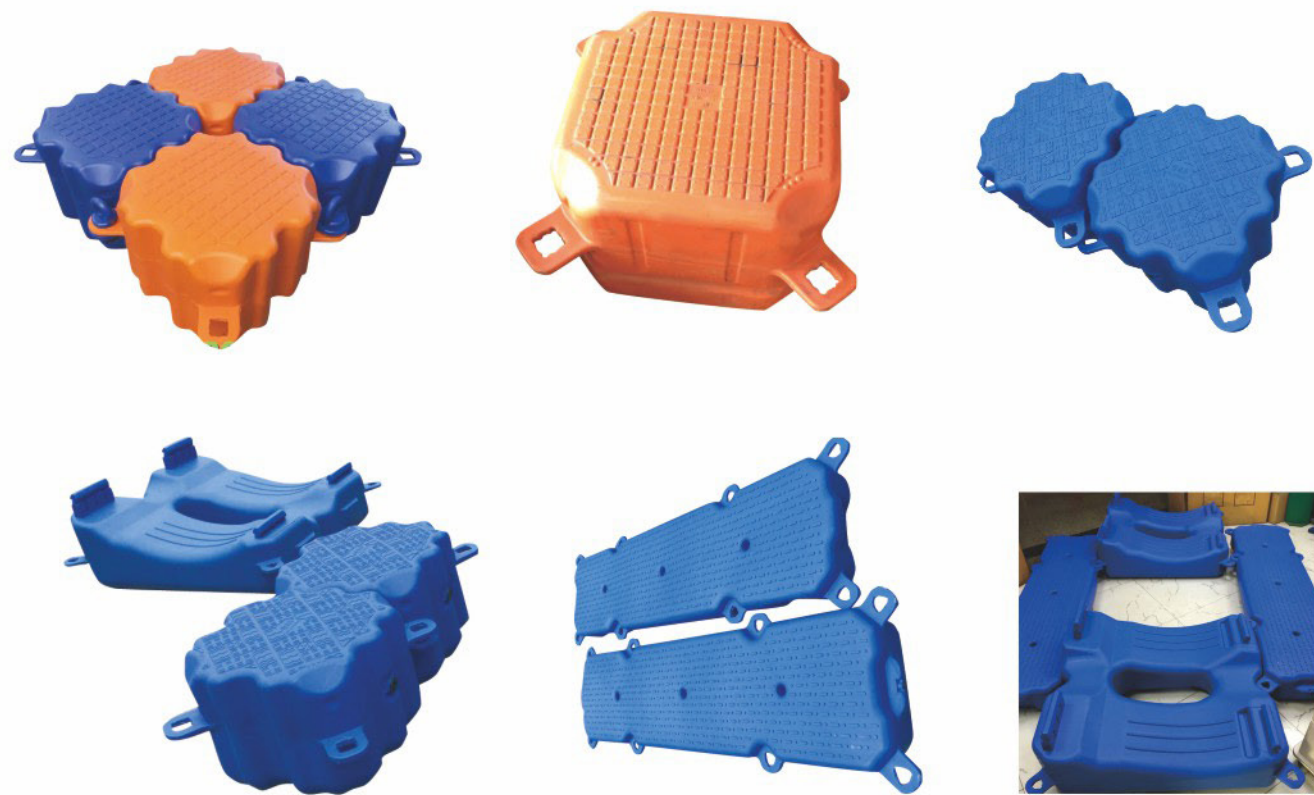

◦ 井盖 Manhole cover



材料Material: plastic PVC
可永久使用Can be used permanently.
尺寸size:

| size | | Weight (KG) | size | | Weight (KG) |
|----------------|-----------|-------------|----------------|-----------|-------------|
| Inner Diameter | Thickness | | Inner Diameter | Thickness | |
| 280 | 10 | 0.9 | 605 | 100 | 18.3 |
| 320 | 15 | 1.7 | 605 | 150 | 26.3 |
| 320 | 30 | 3.8 | 605 | 200 | 33.6 |
| 320 | 50 | 5.9 | 800 | 15 | 4.6 |
| 320 | 100 | 12 | 800 | 30 | 8 |
| 435 | 30 | 4.7 | 800 | 50 | 12.5 |
| 435 | 50 | 7.3 | 800 | 100 | 24.8 |
| 435 | 100 | 15.4 | 425 | (Base) | 22 |
| 605 | 15 | 3.3 | 425 | (Cover) | 13.8 |
| 605 | 30 | 5.9 | 315 | (Base) | 16 |
| 605 | 50 | 9.4 | 315 | (Cover) | 8.5 |

◦ 塑料托盘 *Plastic pallet*

吹塑托盘 Blow molding pallet

尺寸Size 40X48(in) 32X48(in)
重量weight: 10KG 8kg

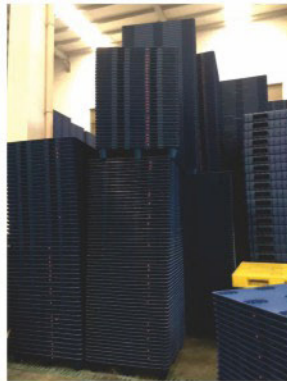

注塑托盘 Injection molding Pallet

尺寸: 1200X1000X150mm
1100X1000X150mm
(Can be customized size)



压塑托盘 Compression molding Pallet

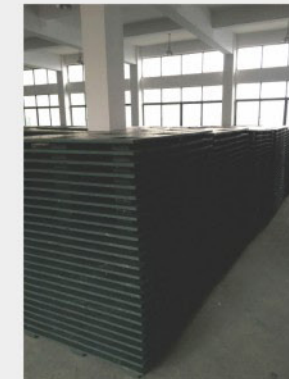

可为客户加工,定制各类大型产品

For customers processing, custom all kinds of large products



| QUOTATION | | | | | |
|---|------------|-----------------|--------------------------------|-------------|------------|
| Plastic Fence | | | | | |
| PICTURE图片 | MODEL 型号 | TOTAL WEIGHT 重量 | SPECIFICATION 规格 | PRICE 出厂价 ¥ | PACKING 包装 |
|  | LZL-DWQ-01 | 3kg/个 | material: Rubber 50X15X10cm | 53/对 pair | |
|  | LZL-DWQ-02 | 3kg | material: Rubber 50X17X13cm | 54/对 pair | |
|  | LZL-DWQ-03 | 4.5kg | material: rubber 60X14X11cm | 60//对 pair | |
|  | LZL-DWQ-04 | | material: rubber 90X15X11cm | 83/个 | 2个/袋 |
|  | LZL-PHJ-01 | 0.45kg | material: plastic 800X9X5mm | 15/个 | 50 根/袋 |
|  | LZL-HJ-01 | 2.5kg | 800X100X10 | 21/个 | 20根/袋 |
| | | 2.4kg | 1000X100X10 | 24/个 | 20根/袋 |